

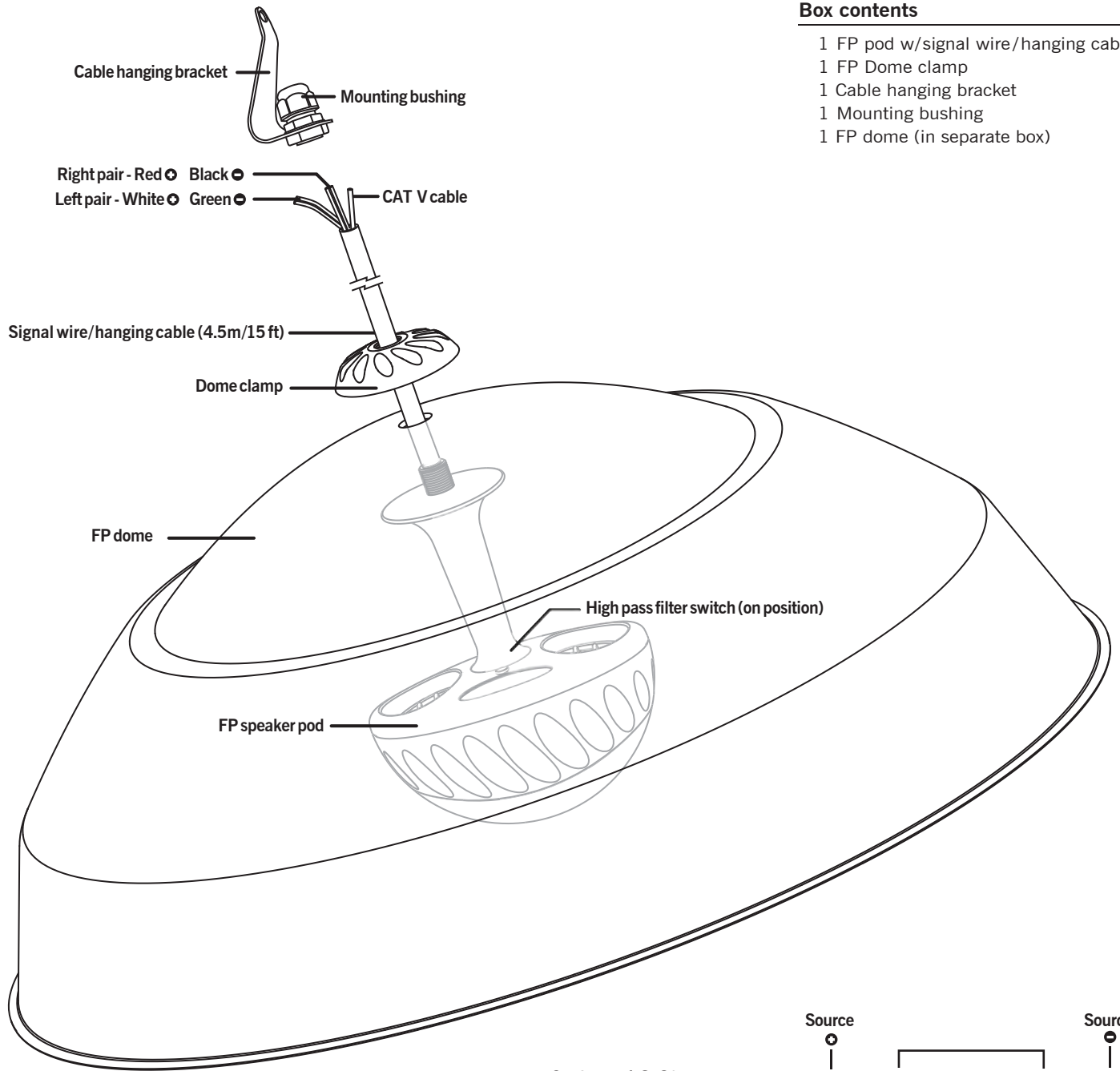

FP Series

Install Instructions For:
FP6030-II and FP6020-II speakers

1.435.647.9555 | 800.647.TUBE | www.soundtube.com



Box contents

- 1 FP pod w/signal wire/hanging cable
- 1 FP Dome clamp
- 1 Cable hanging bracket
- 1 Mounting bushing
- 1 FP dome (in separate box)

Mono Operation: Series - 16 Ohm

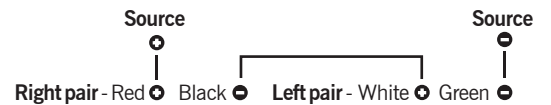

Parallel - 4 Ohm

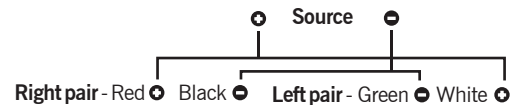

© 2005 SoundTube Entertainment, Inc. All rights reserved. PN INS-FP6 REV03.01.05

Warning

SoundTube speakers must be installed by a professional audio installer/contractor. For safety and for optimum audio performance, installer must follow all directions issued by SoundTube Entertainment.

Warning

Do not spec or install speaker near support beam, ventilation duct or other structure that may interfere with speaker function or dispersion.

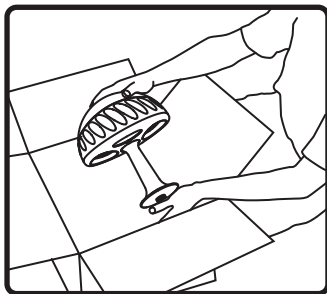

1. Unpack FP speaker pod and FP Dome.

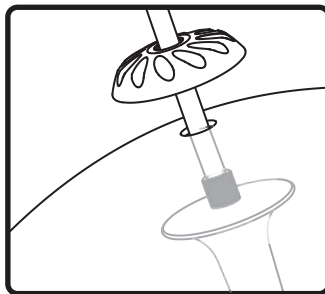

2. Thread signal wire through hole in dome and dome clamp.

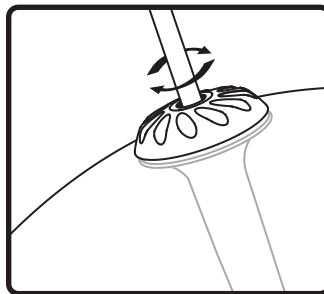

3. Hand tighten dome clamp.

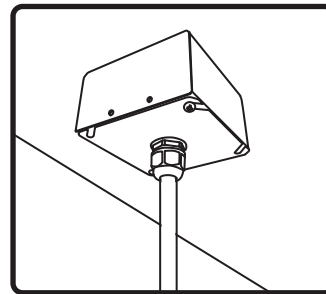

4. To use junction-box w/ face plate (not supplied): Attach mounting bushing to J-box. Thread signal wire thru mounting bushing, adjust height of dome and tighten bushing.

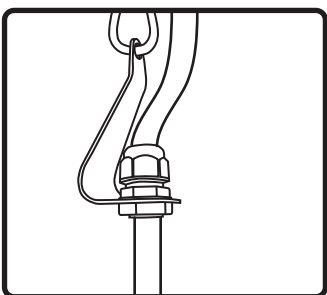

5. To use hanging cable: Attach mounting bushing to cable hanging bracket. Thread signal wire thru mounting bushing, adjust height of dome and tighten bushing.

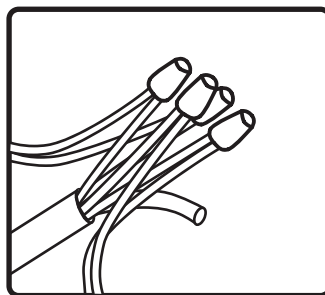

6. Connect signal wire to audio source.
Note - For Mono operation see diagram on reverse side.

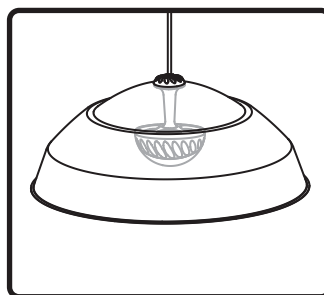

7. Adjust audio level for ambient sound levels. See chart below for recommended levels.

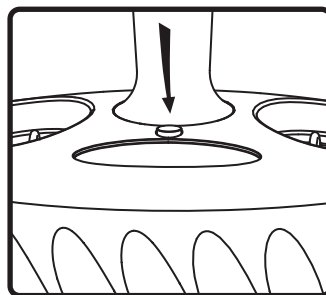

8. Turn high pass filter on or off. When switch is in "up" position, signal is full-range.
Note - In full-range, bass frequencies will bleed outside the dome due to their longer wavelengths.

Hanging height Guidelines

Hang dome 1.5 to 2.0 feet above listener.

Guidelines for setting the SPL

1. Measure ambient noise level of the venue at the busiest time.
2. Stand under the dome and set volume level to +6 dB above the ambient noise level measurement.
3. Step outside the dome and check to see that the SPL of the Dome is not too loud as compared to the ambient noise level.
4. Adjust Equalization to match the program music being played.
*Note - Bass frequencies will bleed outside the dome due to their longer wavelengths.
5. Adjust SPL as necessary. This level will vary based upon the height of the dome.

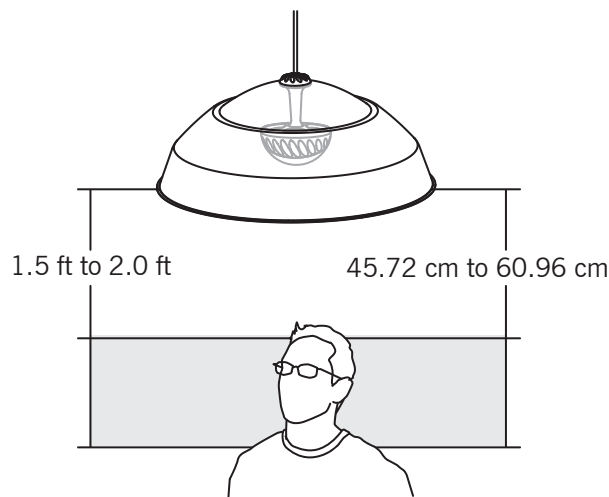



FP Series | Install Instructions For:
FP-Motion

435.647.9555 | 800.647.TUBE | www.soundtube.com

FP modules ship pre-installed from the factory.

Other FP Series optional modules include:

1. LED Light

All modules require a power source. An optional 15 volt source is available from SoundTube (Model number: AC-PS-1530)

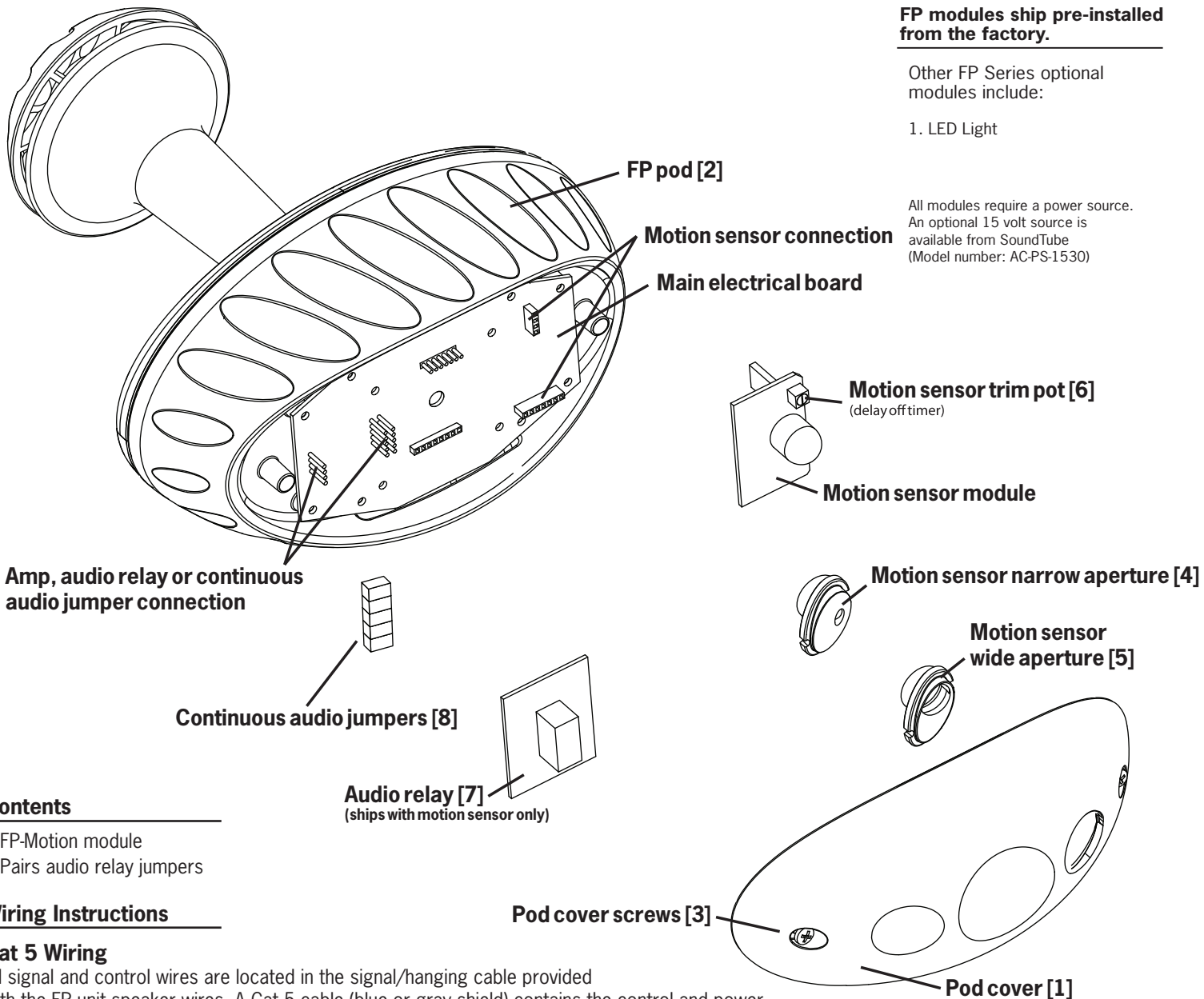

Contents

- 1 FP-Motion module
- 5 Pairs audio relay jumpers

Wiring Instructions

Cat 5 Wiring

All signal and control wires are located in the signal/hanging cable provided with the FP unit speaker wires. A Cat 5 cable (blue or gray shield) contains the control and power wires; audio wires are individual 16-gauge wires in the bundle.

Power

Power ○ = Brown/White
Power ground ○ = Brown

External controller

Contact closure ○ = Green/White
Contact closure ○ = Green
12 V trigger ○ = Blue/White

LED Light

LED control ○ = Orange/White
LED control ○ = Orange

Speaker

Left in ○ = White
Left in ○ = Green
Right in ○ = Red
Right in ○ = Black

435.647.9555 | 800.647.TUBE | www.soundtube.com

FP Series

© 2010 SoundTube Entertainment, Inc. All rights reserved. PN INS-FP-MOTION Rev04.02.10

Warning

SoundTube speakers must be installed by a professional audio installer/contractor. For safety and for optimum audio performance, installer must follow all directions issued by SoundTube Entertainment.

Warning

Do not spec or install speaker near support beam, ventilation duct or other structure that may interfere with speaker function or dispersion.



FP Series | Install Instructions For:
FP-Light

435.647.9555 | 800.647.TUBE | www.soundtube.com

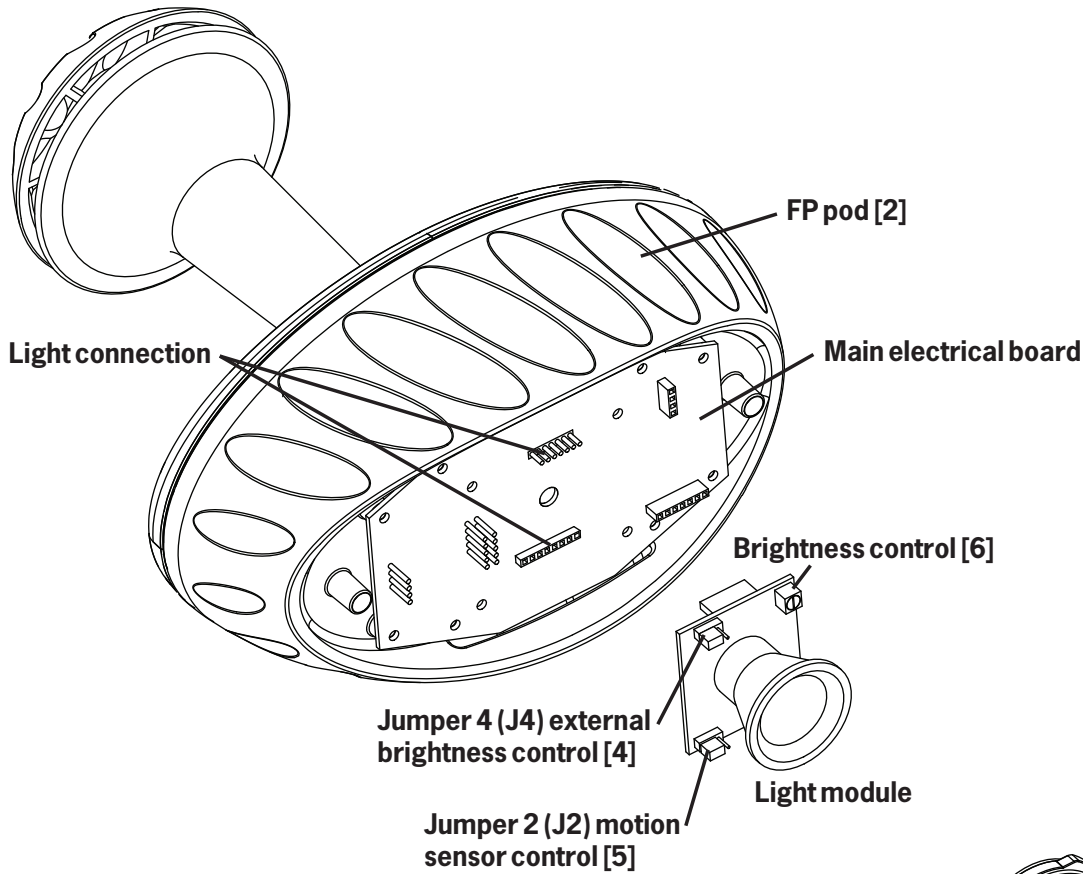

FP modules ship pre-installed from the factory.

Other FP Series optional modules include:

- 1. FP-Motion

All modules require a power source. An optional 15-volt source is available from SoundTube (Model number: AC-PS-1530)

Contents

- 1 FP-Light module
- 2 Jumpers

Wiring Instructions

Cat 5 Wiring

All signal and control wires are located in the signal/hanging cable provided with the FP unit speaker wires. A Cat 5 cable (blue or gray shield) contains the control and power wires; audio wires are individual 16-gauge wires in the bundle.

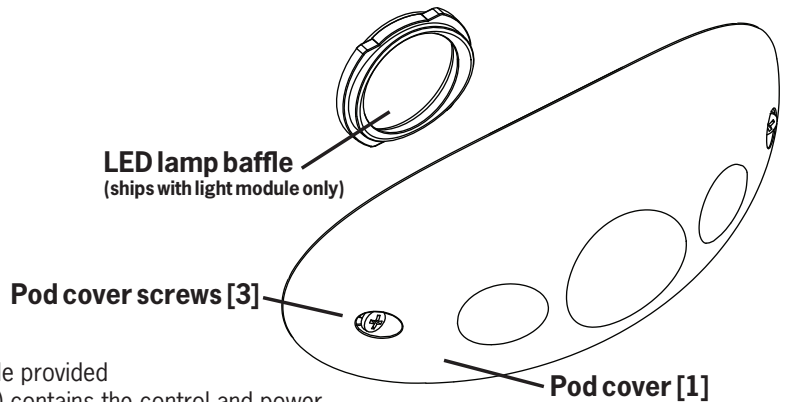

Power

Power ○ = Brown/White
Power ground ○ = Brown

External Controller

Contact closure ○ = Green/White
Contact closure ○ = Green
12 V trigger ○ = Blue/White

LED Light

LED control ○ = Orange/White
LED control ○ = Orange

Speaker

Left in ○ = White
Left in ○ = Green
Right in ○ = Red
Right in ○ = Black

1.435.647.9555 | 800.647.TUBE www.soundtube.com

FP Series

©2010 SoundTube Entertainment, Inc. All rights reserved. PNINS-FP-LIGHT Rev04.02.10

Warning

SoundTube speakers must be installed by a professional audio installer/contractor. For safety and for optimum audio performance, installer must follow all directions issued by SoundTube Entertainment.

Warning

Do not spec or install speaker near support beam, ventilation duct or other structure that may interfere with speaker function or dispersion.

FP-Light | Light Settings and Controls

Module Description

The LED light can operate as a standard light fixture or can be triggered with the FP-Motion module. Brightness can be controlled either internally with an adjustment on the FP-Light module or externally with a global system controller. To trigger the FP-Light with the FP-Motion, refer to Section 3 and the FP-Motion installation instructions.

Section 1 – Wiring The Speaker

Connecting The External Power Supply

The FP-Light requires an external power supply rated between 12 V and 18 V (optional SoundTube accessory: AC-PS-1530) Connect the power supply to the brown/white (+) and brown (-) wires in the CAT 5 cable.

Section 2 – Adjusting the Brightness

Remove The Pod Cover

Remove the pod cover [1] from the FP pod [2] by loosening the two captured screws [3] on each side (Figure 1). The screws will not come out of the cover.

Figure 1

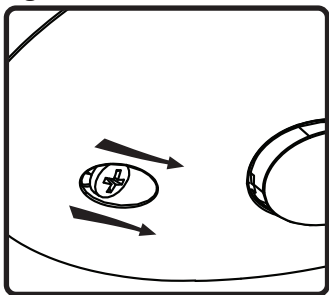

Adjust The Brightness Internally

To manually adjust the brightness of the light use a small screwdriver to turn the trim pot on the upper right corner of the light module [6]. Turning the trim pot clockwise will increase brightness and counterclockwise will decrease brightness.

Adjust The Brightness Externally

The external brightness control is disabled by factory default. To enable the external brightness control, move Jumper 4 [4] on the upper left corner of the FP Light module to the enabled position over the two right pins (Figure 2).

Figure 2

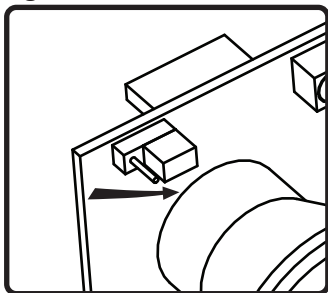

To adjust the brightness externally, incorporate a controller such as Crestron or Lutron and connect the positive lead [+] from the controller to the orange/white wire in the Cat 5, and the negative lead [-] from the controller to the orange wire in the Cat 5. The Light module accepts 0 V to 10 V DC signal to control the brightness. **To achieve maximum brightness, the trim pot must be turned fully clockwise (see previous step).**

Section 3 – Motion Sensor Triggering

Enable The Motion Sensor

Note: To use with motion triggering, both the FP-Light and the FP-Motion modules must be installed.

Since motion sensing is disabled by factory default, the light will be on continuously when power is supplied. To enable motion sensor triggering of the light, move Jumper 2 [5] on the lower left corner of the FP-Light module to the two left pins (Figure 3). When this feature is enabled, the light will only activate when motion is detected. See FP-Motion sensor instructions for settings and controls.

Figure 3

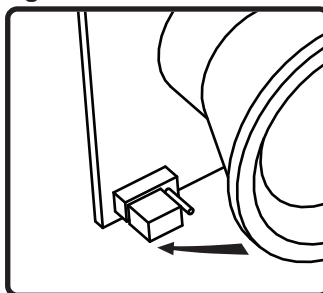

Section 4 – Replacing The Pod Cover

Replace pod cover [1] and tighten screws [3].

FP-Motion | Motion Sensor Settings & Controls

Module Description

The motion sensor is used to trigger actions within the FP product when motion is detected underneath the dome. Potential actions include triggering the FP's 12 V output signal, activating the contact closure, activating an audio stream, turning on an LED lamp (if installed), and triggering an optional ScentAir module (if installed).

To integrate the FP-Light, refer to those instructions

Section 1 – Wiring The Speaker

Connect External Power Supply

The motion sensor requires an external power supply rated between 12 V and 18 V (optional SoundTube accessory: AC-PS-1530) Connect the power supply to the brown/white (+) and brown (-) wires in the CAT 5 cable.

Connect Contact Closure

To connect the contact closure to an external device, connect the green/white (+) and green (-) wires in the Cat 5 cable to the corresponding wires in the external device.

Connect 12 V Trigger

To connect the 12 V output signal trigger to an external device (i.e., external audio source), connect the blue/white (+) and brown (-) wires in the Cat 5 cable to the corresponding wires in the external device. Note: the brown wire is shared with the power ground.

Section 2 – Adjusting the Aperture Lens

Define the Aperture Setting

The FP-Motion ships with the narrow aperture lens installed as the default. The narrow aperture covers a 3-foot (0.9 m) radius when the dome is hung at 7.5 feet (2.3 m). The wide aperture covers a 6-foot (1.8 m) radius when the dome is hung at 7.5 feet (2.3 m).

Install the Wide Lens Aperture

To install the wide aperture lens, remove the pod cover [1] from the FP pod [2] by loosening the two captured screws [3] on each side (Figure 1). The screws will not come out of the cover.

Figure 1

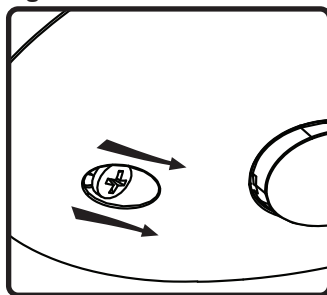

To remove the narrow aperture lens [4], GENTLY press outward on the tab on the inside cover with a small screwdriver while pushing inward on the lens (Figure 2).

Figure 2

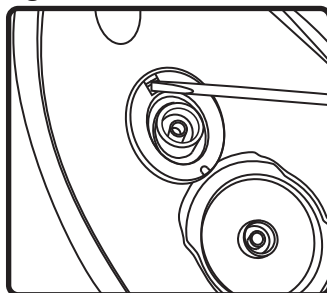

*** CAUTION *** Using excessive force on the tab will break the tab and ruin the pod cover.

To insert the wide aperture lens [5], align the notch on the lens and gently snap it into place by hand (Figure 3).

Figure 3

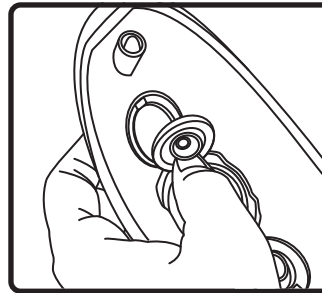

Section 3 – Setting Motion Time Delay

Time Delay Default

The FP-Motion has an instant-on, time-delay-off functionality and ships preset to a 5-second delay off. The delay off can be adjusted manually from 2 – 12 seconds. As long as motion is detected, the module's timer is continuously reset. Once no motion is detected, the delay-off timer is activated.

Adjust the Time Delay Manually

To adjust the time delay, remove the pod cover [1] from the FP pod [2] by loosening the two captured screws [3] on either side. Using a small screwdriver, turn the motion sensor trim pot [6] clockwise to increase time delay and counterclockwise to decrease it.

Figure 4

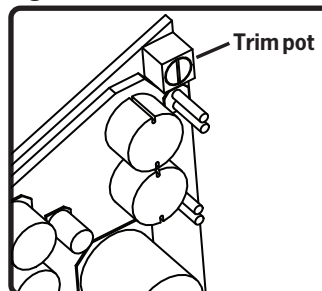

Section 4 – Using The Audio Relay and Continuous Audio

The FP-Motion module ships with a relay board [7] installed which engages the audio path when motion is detected. When there is no motion detected, the audio stream is disabled.

Enable Continuous Audio

If you don't want the FP to disable the audio stream when no motion is detected, then replace the included audio relay board with 5 included jumpers [8] (Figure 5). The audio will play continuously whether or not motion is detected.

Figure 5

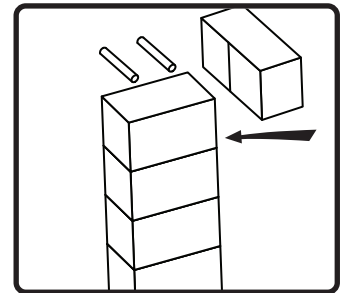

Section 5 - Replacing The Pod Cover

Replace pod cover [1] and tighten screws [3].