

RERUN ARCHITECTURAL DMX512 RECORDER

MODEL RERUN-A

OWNERS MANUAL



Doug Fleenor Design
396 Corbett Canyon Road
Arroyo Grande, CA 93420
(805) 481-9599

PRODUCT DESCRIPTION

The *Rerun Architectural* is a lighting control station capable of storing up to ten 40-minute shows. Shows are recorded by capturing the output of a DMX512 console. The recorded show start and end points may be trimmed non-destructively. Each show can be set to hold the last look, loop to itself or link to another show. Shows are started by pressing one of the ten show buttons.

A basic system consists of a *Rerun Architectural* station and a power supply. The solid aluminum faceplate is designed to install over a standard two gang electrical box. Single gang remote stations can be added to remotely select shows. Connections to the *Rerun Architectural* are power (2 wires), DMX512 Input (3 wires) and DMX512 Output (3 wires). Power for the *Rerun Architectural* can be supplied from a variety of sources, including a 10V class 2 “doorbell” transformer.

The *Rerun Architectural* system can work in conjunction with a lighting console, automatically switching between recorded shows and console control. When the console generates DMX512 the *Rerun Architectural* retransmits the incoming DMX512 data. Thus the console operates normally. Upon loss of DMX512 from the console, the *Rerun Architectural* starts its previously active show.

Rerun also comes in a portable version (model RERUN-P) and a rack mount version (model RERUN-R?) The *Rerun Architectural* and *Rerun Portable* units can support one universe of DMX512 data. The rack mount version can be built to support multiple universes of DMX512. Substitute the number of universes in place of the question mark in the model number for the rack mount version. As many as four universes can be supported in a single 1U chassis. Additional universes can be supported in the rack mount version using expansion units.

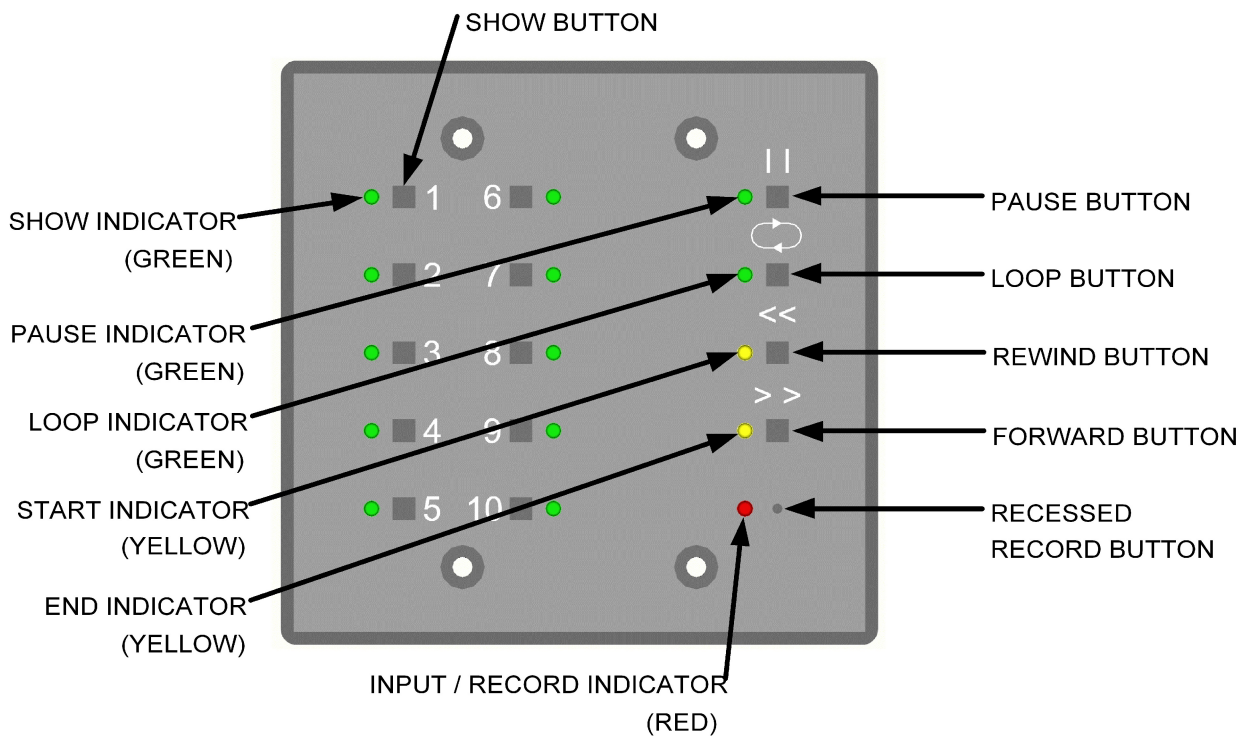

SPECIFICATIONS

Connector:	Terminal block #1 Phoenix Contact MSTB series 5 position two part terminal block Model: MSTB 2,5/5-ST-5,08 Order number: 17 57 04 8	Terminal block #2 Phoenix Contact MSTB series 3 position two part terminal block Model: MSTB 2,3-G-5,08 Order number: 17 55 74 9
------------	---	--

Connector pin out:	Terminal Block #1 (DMX512 Output) 1 (C) DMX512 common 2 (-) DMX512 data - 3 (+) DMX512 data + 4 (C) Supply common (internally tied to pin1) 5 (V) Supply voltage "hot"	Terminal Block #2 (DMX512 Input) 1 (C) DMX512 common 2 (-) DMX512 data - 3 (+) DMX512 data +
--------------------	--	---

Input Circuit: ESD protected EIA-485 transceiver (LT1785)

Output Circuit: ESD protected EIA-485 transceiver (LT1785)

Isolation: None. DMX input is not isolated from DMX output.

Indicators: Ten green SHOW LEDs
One green PAUSE LED
One green LOOP LED
One yellow START LED
One yellow END LED
One red INPUT/RECORD LED

User controls: Ten [SHOW] buttons
One [PAUSE] button
One [LOOP] button
One [REWIND] button
One [FORWARD] button
One recessed [RECORD] button

Option Jumpers:	INSTALLED	REMOVED
JP1	Recording enabled	Recording/editing disabled
JP2	Run show on DMX512 loss	Hold last look on DMX512 loss
JP3	Normal operation	Run hardware test
JP4	Normal operation	Factory use only
JP5	Pile-on mode disabled	Pile-on mode enabled
JP6	Normal operation	Erase memory (DANGER!)

SPECIFICATIONS (CONTINUED)

Power input: 9 to 15 volts AC or DC / 150mA per station
(A 10 volt class 2 "doorbell" transformer is recommended for fixed installations)

Color: Black anodized with laser engraved nomenclature

Size : Faceplate: 4.5"H x 0.2"D x 4.6"W
Faceplate rear inset: 4.15"H x 0.1"D x 4.25"W
Electrical box minimum inside dimensions: 2.9"H x 1.5"D x 3.5"W

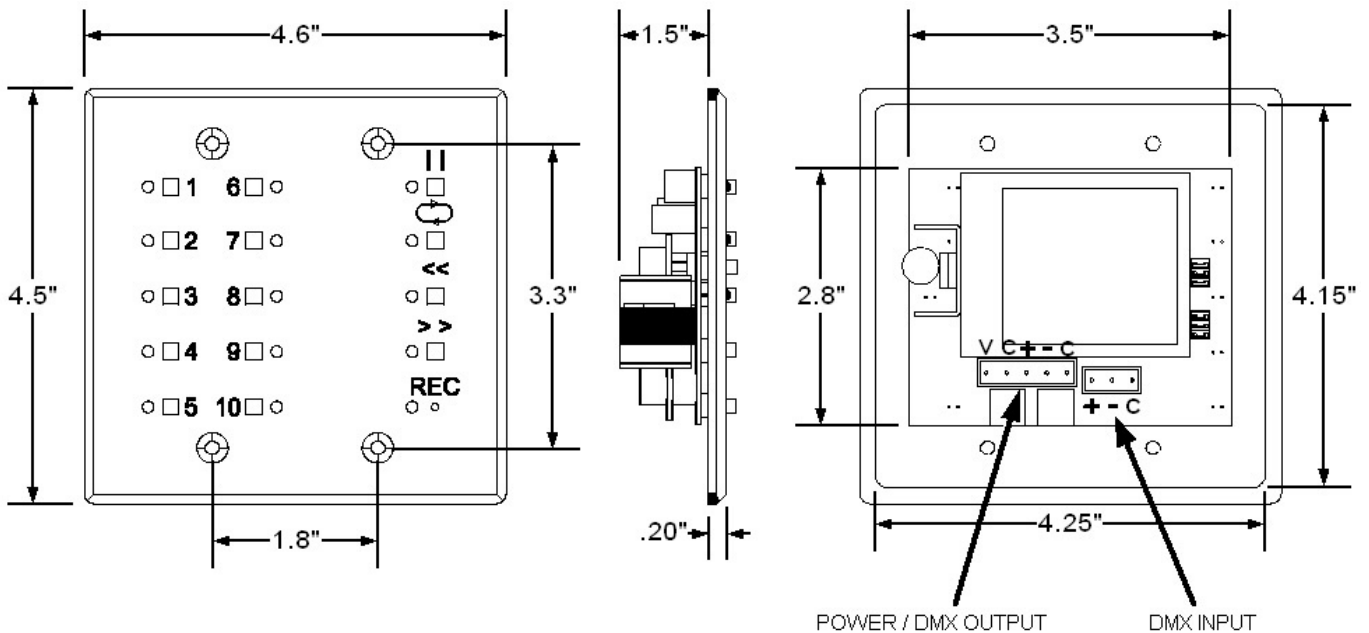

POWER SUPPLY

The voltage provided to the *Rerun Architectural* must be between 9 and 15 volts AC or DC. The *Rerun Architectural* has been designed to operate on a standard class 2 "doorbell" transformer. For example Ace Hardware's model# ACE36483 10 volt 5 watt transformer.

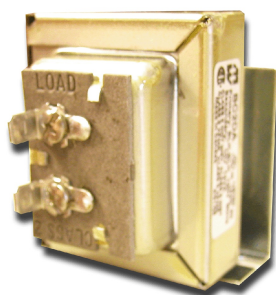

Doorbell
Transformer

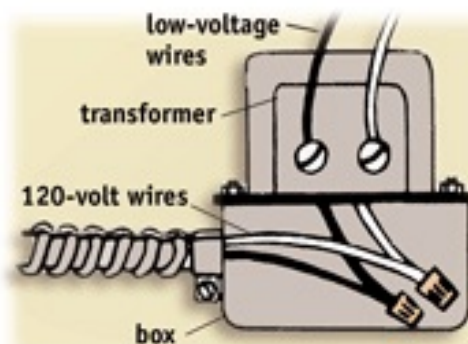

WIRING INFORMATION

Rerun Architectural is designed to use daisy-chain wiring topology. Please give us a call if you have any questions.

Note:

- DMX512 from a console will not pass through if the *Rerun Architectural* is not powered.

CABLE	COLOR	FROM		TO		USE
1 120 Ohm Data Cable Belden 9829 or Equivalent	Shield	XLR Plate	Pin 1	RERUN-A	DMX IN (C)	Common
	White/Blue		Pin 2		DMX IN (-)	Data -
	Blue/White		Pin 3		DMX IN (+)	Data +
2 (2) #16 AWG Stranded Wires	Black	Power Supply	Common	RERUN-A	PWR/DMX OUT (C)	Supply
	Red		Power		PWR/DMX OUT (V)	Supply "hot"
5 120 Ohm Data Cable Belden 9829 or Equivalent	Shield	RERUN-A	PWR/DMX OUT (C)	Dimmer Cabinet	?	Common
	White/Blue		PWR/DMX OUT (-)		?	Data -
	Blue/White		PWR/DMX OUT (+)		?	Data +

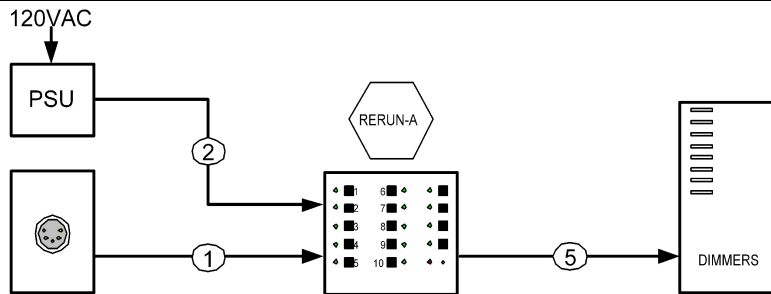

OPTIONAL REMOTE PANEL

CABLE	COLOR	FROM		TO		USE
1 120 Ohm Data Cable Belden 9829 or Equivalent	Shield	XLR Plate	Pin 1	PRE10-A Remote	TB1-1	Common
	White/Blue		Pin 2		TB1-2	Data -
	Blue/White		Pin 3		TB1-3	Data +
2 (2) #16 AWG Stranded Wires	Black	Power Supply	Common	PRE10-A Remote	TB1-4	Supply
	Red		Power		TB1-5	Supply "hot"
3 120 Ohm Data Cable Belden 9829 or Equivalent	Shield	PRE10-A Remote	TB1-1	RERUN-A	DMX IN (C)	Common
	White/Blue		TB1-2		DMX IN (-)	Data -
	Blue/White		TB1-3		DMX IN (+)	Data +
4 (2) #16 AWG Stranded Wires	Black	PRE10-A Remote	TB1-4	RERUN-A	PWR/DMX OUT (C)	Supply
	Red		TB1-5		PWR/DMX OUT (V)	Supply "Hot"
5 120 Ohm Data Cable Belden 9829 or Equivalent	Shield	RERUN-A	PWR/DMX OUT (C)	Dimmer Cabinet	?	Common
	White/Blue		PWR/DMX OUT (-)		?	Data -
	Blue/White		PWR/DMX OUT (+)		?	Data +

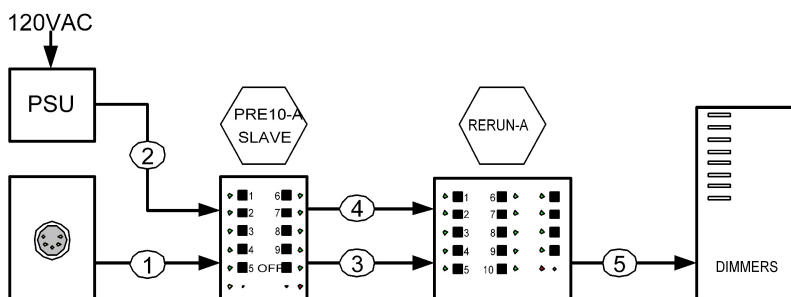

RERUN ARCHITECTURAL FACEPLATE CONFIGURATION

Each *Rerun Architectural* has six jumpers, JP1 through JP6, that select different modes of operation. The factory default is to have all jumpers installed.

- JP1** Record Lockout - When removed, the [RECORD] button is disabled. When installed, recording of presets is enabled.
- JP2** Hold Last Look - When removed, upon the loss of signal the last valid input is held on the output. When installed, upon the loss of signal the last active show is started.
- JP3** Hardware Test - *Rerun Architectural* enters a hardware test mode when this jumper is removed.
- JP4** Leave installed. This jumper is only removed for factory use.
- JP5** When installed, incoming DMX512 signals will override the *Rerun Architectural* levels and all shows will be locked out. When removed, incoming levels will be combined with those of the active show on the *Rerun Architectural* in a highest-takes-precedence (HTP) fashion.
- JP6** CF Card initialize - When removed, the memory card is erased at power up. Use with CAUTION!

REMOTE SHOW RECALL PANEL

Remote control of the *Rerun Architectural* system is accomplished by use of a *Preset 10 Architectural* (model PRE10-A) panels. The remote panel provides ten show buttons and twelve indicators (Figure 1). Multiple remote panels can be connected in a daisy chain manner to the DMX512 input on the *Rerun Architectural*.

NOTE: Remote panels must be wired to the DMX512 INPUT connector on the Rerun.

The remote panel must be configured as a remote station. Remove the jumpers located at JP2 and JP4 to configure a *Preset 10 Architectural* as a remote station (Figure 2). Place the jumper over only one of the pins at JP2 and JP4 for storage.

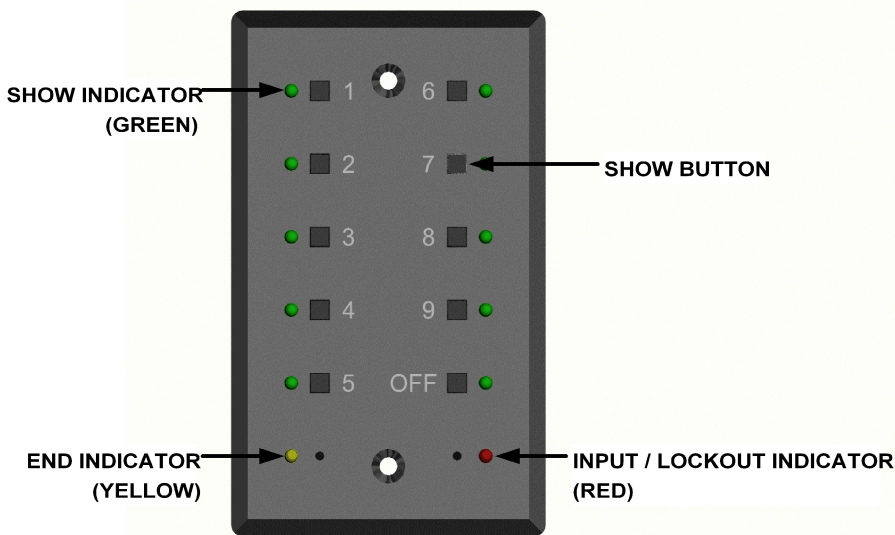

(Figure 1)

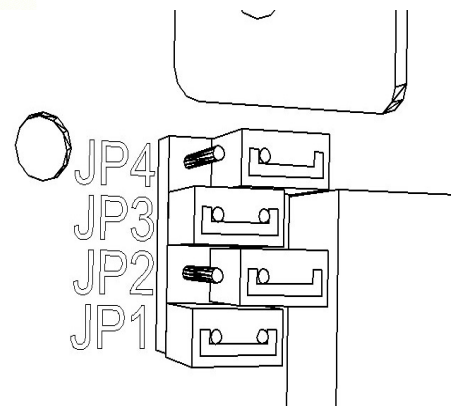

(Figure 2)

INDICATORS

ON = ILLUMINATED LED
 OFF = EXTINGUISHED LED
 ALL FLASH = SHOW LEDS 1 THROUGH 10 ILLUMINATED ONCE PER SECOND CONTINUOUSLY
 FLASH = ILLUMINATED ONCE PER SECOND CONTINUOUSLY
 BLINK = ILLUMINATED ONCE ONLY

GREEN SHOW LED	GREEN PAUSE LED	GREEN LOOP LED	YELLOW START LED	YELLOW END LED	RED RECORD LED	STATE
OFF	OFF	OFF	OFF	OFF	OFF	UNIT NOT POWERED
ON	OFF	OFF	OFF	OFF	OFF	PLAYBACK OF PRESET
ON	OFF	OFF	OFF	ON	OFF	PLAYBACK AT END POINT
ON	ON	OFF	OFF	OFF	OFF	PLAYBACK PAUSED
ON	ON	ON	OFF	OFF	OFF	SHOW SET TO LOOP OR LINK
ON	ON	ON	OFF	BLINK	OFF	SHOW AT END POINT AND LOOPED TO START POINT
OFF	OFF	OFF	OFF	OFF	ON	RECEIVING DMX512 THE <i>RERUN-A</i> IS LOCKED OUT FROM RUNNING SHOWS AND IS PASSING CONSOLE DATA TO THE OUTPUT
ALL FLASH	OFF	OFF	OFF	OFF	ON	RECEIVING DMX512 READY TO RECORD
ON	OFF	OFF	OFF	OFF	FLASH	SHOW CURRENTLY BEING RECORDED
ON	ON	OFF ON	N/A	N/A	OFF	LOOP STATUS IN SHOW RECORD ON= ENABLED OFF= DISABLED
ON FLASH	ON	N/A	N/A	N/A	OFF	ON = SELECTED SHOW FLASH = SHOW TO LINK TO
ON	ON	N/A	FLASH	N/A	OFF	PLAYBACK POINTER AT START OF RECORDED SHOW
ON	ON	N/A	ON	N/A	OFF	PLAYBACK POINTER AT START POINT
ON	ON	N/A	N/A	FLASH	OFF	PLAYBACK POINTER AT END OF RECORDED SHOW
ON	ON	N/A	N/A	ON	OFF	PLAYBACK POINTER AT END POINT
ALL FLASH	FLASH	FLASH	FLASH	FLASH	FLASH	COMPACT FLASH CARD NOT FOUND

THE ANATOMY OF A SHOW

The *Rerun Architectural* has ten show memories each capable of recording 40 minutes of DMX512 data. Within each show memory are non-destructive trim points called the START POINT and the END POINT. The show memory is the data space used to store the show. Its time line always starts at the top of the show memory (the point at which the [SHOW] button was pressed to begin recording). The show time line continues until the bottom of the show (the point at which the [SHOW] button was pressed to stop recording) or when the recorded show exceeds the show memory at 40 minutes. The START POINT is the point at which your show will begin to playback when the [SHOW] button is depressed. The END POINT is the point at which the show will end. By default when you record a show the START POINT and END POINT are positioned at the top and bottom of the recorded show (Figure 1). The START POINT and END POINT can be moved to any time within the recorded show allowing you to non-destructively trim the show (Figure 2).

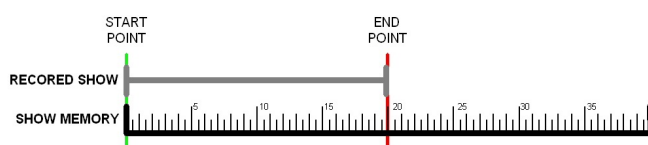

Figure 1

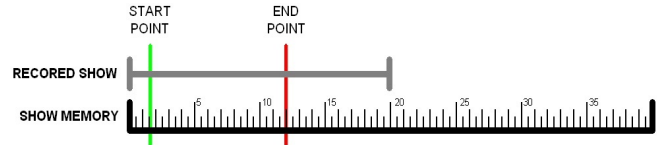

Figure 2

RECORDING SHOWS

In order to capture the individual channel levels recorded to a show, the *Rerun Architectural* must be connected to a DMX512 source. It is recommended that your console output all 512 slots. When fewer than 512 slots are received a level of 0 will be stored for all slots above those received. To allow you to observe the show being recorded the *Rerun Architectural* echos data being received on its output port.

1. Using the primary DMX512 console, go to the beginning of the show to be recorded.
2. Using a small blunt object (e.g. paper clip), depress the recessed [RECORD] button located next to the RED LED. The SHOW LEDs will begin to flash and the RECORD LED will illuminate. If you decide after depressing the [RECORD] button that you do not wish to record a show, depress the [RECORD] button a second time. No changes will have been made.
3. Depress the [SHOW] button adjacent to the show number you wish to record. The show will immediately begin recording. The adjacent SHOW LED will indicate the show being recorded and the RECORD LED will flash.
4. Start running the show to be recorded on the DMX512 console.
5. To stop recording depress the [SHOW] button adjacent to the show number you are recording.

Repeat steps 1 through 4 until you have recorded as many shows as desired, up to ten total.

Note:

- DMX512 from a console will not pass through if the *Rerun Architectural* is not powered.

PLAYBACK OF SHOWS

Recorded shows may not be played when there is incoming DMX512 unless the pile-on jumper (JP5) has been removed. When DMX512 from a console is present, the *Rerun Architectural's* RED LED will be on and the only action possible is recording of a show. When the "pile-on" jumper is removed, incoming DMX512 data will be piled onto the currently running show in a highest-takes-precedence fashion.

Playing a show

Shows are played by pressing one of the [SHOW] buttons. When a [SHOW] button is pressed, the current show will stop running. The *Rerun Architectural* will then execute a two second fade from the current levels to the levels at the START POINT of the new show. After the fade is complete, the new show will start running. The SHOW LED will illuminate adjacent to the button that was pressed.

The two second fade feature can be disabled (see Editing Show Parameters). If the fade feature has been disabled in the newly selected show, selecting that show will immediately stop the current show and start the new show from its START POINT.

When a show comes to its end and looping has been enabled (the default state) the show will start over from its START POINT. If looping has not been enabled the *Rerun Architectural* will continue sending the last levels of the show until another show is selected. The END LED will light to show that the end of the current show has been reached.

Note:

- If a show is playing at the time power is lost, the *Rerun Architectural* will return to the start of that show when power is restored.
- DMX512 from a console will not pass through if the *Rerun Architectural* is not powered.

Pausing a show

A running show can be paused by pressing the [PAUSE] button. When a show is paused the PAUSE LED will be lit and the *Rerun Architectural* will continue sending the current DMX512 values for that point in the show. While paused, various show parameters can be edited. See the section on show editing for details.

A paused show can be resumed by pressing the [PAUSE] button again. The PAUSE LED will extinguish and the show will continue playing from the point at which it was paused.

Looping a show

When a show is selected, its recorded loop status is loaded. This is indicated by the LOOP LED. The loop status of a show can be temporarily overridden. While the show is running, push the [LOOP] button. This will toggle the temporary state of the LOOP LED. If the show was looping, the [LOOP] button will cancel the loop. If it was not looping, the [LOOP] button push will enable looping. Pressing the show button will reload the recorded loop status for the show and re-start the show from its START POINT. Altering a show's loop status while it is running is temporary. It is not recorded with the show.

Note:

- Looping can also be recorded into the show. This is covered in the editing show parameters section of the manual.

LOCKING THE FRONT PANEL

There is an option which will allow the front panel of the *Rerun Architectural* to be locked to prevent unauthorized operation. This feature is disabled by default. When the feature is enabled, the station can be locked or unlocked by tapping the active [SHOW] button three times. When entering the lock mode, all of the front panel LEDs will flash once. The LEDs will not flash when exiting the front panel lock mode.

EDITING SHOW PARAMETERS

A number of parameters can be edited in recorded shows and for system-wide functions. These include the start point, end point, looping/linking status, linked show number, cross fading, recording lockout, end of show output disable, and front panel lockout.

Setting start and end points

The [REWIND] and [FORWARD] buttons are used to set the start and end points. These buttons are only active while a show is paused. When paused, the buttons can be used to move the playback pointer forward or backward through the show. The longer each button is held, the faster the show will be forwarded or rewound. When the playback pointer is at the top of the recorded show, the START LED will flash. When the playback pointer reaches the bottom of the recorded show, the END LED will flash. When the playback pointer is at the START POINT, the START LED will turn on solid. When the playback pointer is at the end point, the END LED will turn on solid. See below for the meanings of these terms and for details on editing them.

Start point

The START POINT is the point in the show at which playback will begin when that show is selected. To set the START POINT, do the following:

1. Start playing the show to be edited.
2. Pause the show near the desired START POINT.
3. While paused, use the [REWIND] or [FORWARD] buttons to move the playback pointer and locate the desired START POINT.
4. Press and hold the recessed [RECORD] button. A paper clip can be used to push this button. While holding the [RECORD] button, press the [REWIND] button. After it is pressed, the START LED will turn on indicating that this point in the show is the start.

Note:

- The START POINT is set to the top of the show when that show is first recorded.
- The START POINT must be set to a point in the show before the END POINT. If you attempt to set the START POINT to a point after the END POINT, the set START POINT command will be ignored.
- Once recorded, show data is never discarded. If you set a START POINT a few minutes into a recorded show, those minutes of data still exist. You can start the show, pause it, and rewind into the previously trimmed out area. A new START POINT can then be set.

End point

The END POINT is the end of the show. To set the END POINT, do the following:

1. Start playing the show to be edited.
2. Pause the show near the desired END POINT.
3. While paused, use the [REWIND] or [FORWARD] button to move the playback pointer and locate the desired END POINT.
4. Press and hold the recessed [RECORD] button. A paper clip can be used to push this button. While holding the [RECORD] button, press the [FORWARD] button. After it is pressed, the END LED will turn on indicating that this point in the show is the END POINT.

Note:

- The END POINT is set to the bottom of the show when that show is first recorded.
- The END POINT must be set to a point in the show after the START POINT. If you attempt to set the END POINT to a point before the START POINT, the set END POINT command will be ignored.
- Once recorded, show data is never discarded. If you set an END POINT a few minutes before the bottom of a recorded show, those minutes of data still exist. You can start the show, pause it, and forward into the previously trimmed out area. A new END POINT can then be set.

EDITING SHOW PARAMETERS (CONTINUED)

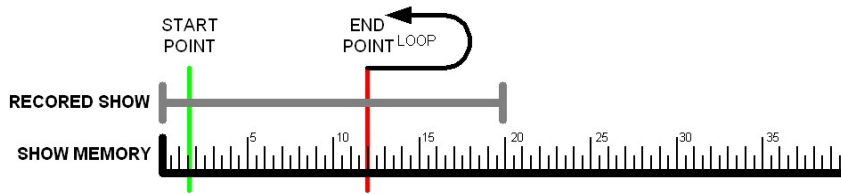

Looping

By default, shows are looping. This means that when the show comes to its end, the show will automatically re-start itself from the START POINT and run in a continuous loop. When looping is disabled, the show stops at the END POINT and the *Rerun Architectural* will send the last levels of the show until another show is selected.

The looping feature can be temporarily enabled or disabled as described in the show playback section. To permanently change a show's looping status, do the following:

1. Start playing the show to be edited.
2. Pause the show at any point. The LOOP LED will immediately display the recorded status of the looping feature for that show. When the LOOP LED is on, looping is enabled.
3. Press and hold the recessed [RECORD] button. A paper clip can be used to push this button. While holding the [RECORD] button, press the [LOOP] button. After it is pressed, the LOOP LED will change indicating the show's new looping status.
4. Press the [PAUSE] button to save the new loop status with the show and to resume playing.

Note:

- When a show selection button is pressed, the loop status will be updated from the recorded show data. This will override any manual looping selections made previously.

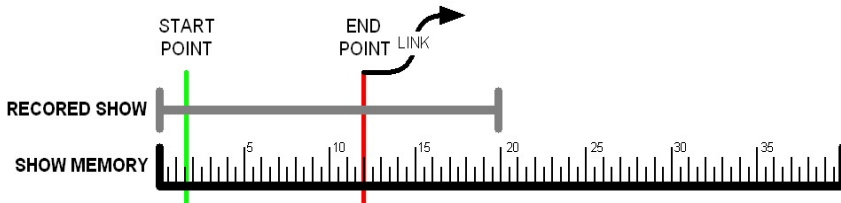

Linking

This feature is for advanced users only. Linking is similar to show looping. However, with linking, when a show reaches its end, instead of looping to re-start itself, a different show is started. You can select which show is linked. This powerful feature allows the user to create longer and more complex shows.

To link shows, do the following:

1. Start playing the first show.
2. Pause the show at any point.
3. If it is not enabled already, enable looping for the show (Looping section above).
4. Press and hold the recessed [RECORD] button. A paper clip can be used to push this button. While holding the [RECORD] button, press one of the [SHOW] buttons to choose which show will play after the current one. The LED for that show will flash and the LED for the current show will remain on solid.
5. Press the [PAUSE] button to save the new settings and to resume the show. When the show you just edited finishes playing, the linked show will begin playing. The link and loop status of the next show will be executed with the new show.

Note:

- To re-link a show to itself, simply edit the link as described above, but select the current show as the show to be linked. The current show LED will stay on solid and all other show selection LED's will turn off.
- Turning off the loop feature also disables the link function for the current show.
- When paused, the loop and link status for the current show are displayed.

EDITING SHOW PARAMETERS (CONTINUED)

Cross fading

Each show can have the cross fade function enabled or disabled. When enabled (the default state), the show will execute a two second fade from the current levels to the levels at the START POINT of the show when that show is selected. When cross fading is disabled for a show, the levels will jump immediately from the current levels to the levels at the START POINT of the show.

To enable or disable cross fading, do the following:

1. Start playing the show to be edited.
2. Pause the show at any point.
3. Press and hold the number 10 [SHOW] button. Hold the number 10 [SHOW] button for about five seconds. While held, the remaining [SHOW LEDS] will indicate the status of other show and system parameters. The number 3 [SHOW LED] indicates the status of the cross fade option for that show. While continuing to hold the number 10 [SHOW] button, press the number 3 [SHOW] button to toggle the state of the option. When the number 3 [SHOW LED] is lit, the cross fade option is enabled. Set the cross fading option as desired.
4. Release the number 10 [SHOW] button.
5. Press the [PAUSE] button to save the new settings and to resume the show. The next time the show is selected, it will start using the cross fade option as just recorded.

End of show output

When a show is set to stop running at the END POINT (not looping) the behavior of the *Rerun Architectural* can be set up in two different ways. By default, a show stops at its END POINT and the *Rerun Architectural* continues to send the last levels of that show until a new show is selected. Each show can be set up to stop sending DMX512 data entirely at the end of the show. By going off-line, many moving lights and dimming systems will detect the loss of DMX512 and begin their shut down routines.

To alter the end-of-show behavior, do the following:

1. Start playing the show to be edited.
2. Pause the show at any point.
3. If it is not disabled already, disable looping for the show (Looping section above).
4. Press and hold the number 10 [SHOW] button. Hold the number 10 [SHOW] button for about five seconds. While held, the remaining [SHOW LEDS] will indicate the status of other show and system parameters. The number 2 [SHOW LED] indicates the status of the end-of-show output option for that show. While continuing to hold the number 10 [SHOW] button, press the number 2 [SHOW] button to toggle the state of the option. When the number 2 [SHOW LED] is lit, the *Rerun Architectural* will stop DMX512 output at the end of the show. When the number 2 [SHOW LED] is off, the *Rerun Architectural* will continue sending DMX512 at the end of the show. Set the end-of-show transmission option as desired.
5. Release the number 10 [SHOW] button.
6. Press the [PAUSE] button to save the new settings and to resume the show.

Note:

- The end-of-show behavior will only apply if the show has looping disabled.
- If the pile-on feature is enabled, the DMX512 output will remain active if there is an input signal present. In this case, the output will remain active even if the completed show is set to disable the DMX512 output.

EDITING SHOW PARAMETERS (CONTINUED)

Software record lockout

In addition to the hardware jumper record lockout feature, the *Rerun Architectural* has a software record lockout feature. When the software record lockout is enabled, no shows can be recorded and no parameter data can be modified. The hardware record lockout jumper takes precedence over the software record lockout. If the hardware record lockout jumper is removed, no data can be altered regardless of the state of the software record lockout feature.

To alter the software record lockout status, do the following:

1. Start playing any show.
2. Pause the show at any point.
3. Press and hold the number 10 [SHOW] button. Hold the number 10 [SHOW] button for about five seconds. While held, the remaining [SHOW LEDS] will indicate the status of other show and system parameters. The number 1 [SHOW LED] indicates the status of the software record lockout output option. While continuing to hold the number 10 [SHOW] button, press the number 1 [SHOW] button to toggle the state of the option. When the number 1 [SHOW LED] is lit, the *Rerun Architectural* will not allow any show or parameter data to be changed. When the number 1 [SHOW LED] is off, the *Rerun Architectural* will allow changes to be made. Set the software record lockout option as desired.
4. Release the number 10 [SHOW] button.
5. Press the [PAUSE] button to save the new settings and to resume the show.

Note:

- The software record lockout feature is a global system parameter. Although it can be accessed from any show, there is only one record lockout state.
- By default, the hardware lockout jumper is installed (recording enabled), and the software record lockout feature is disabled (recording enabled).
- The hardware record lockout jumper must be installed for the software record lockout to have any effect on the system.

Front panel lockout

The front panel buttons on the *Rerun Architectural* can be locked to prevent tampering with a running show. The ability to lock out the front panel is disabled by default.

To enable or disable the ability to lock the front panel, do the following:

1. Start playing any show.
2. Pause the show at any point.
3. Press and hold the number 10 [SHOW] button. Hold the number 10 [SHOW] button for about five seconds. While held, the remaining [SHOW LEDS] will indicate the status of other show and system parameters. The number 4 [SHOW LED] indicates the status of the front panel lockout output option. While continuing to hold the number 10 [SHOW] button, press the number 4 [SHOW] button to toggle the state of the option. When the number 4 [SHOW LED] is lit, the *Rerun Architectural* will allow the front panel to be locked. When the number 4 [SHOW LED] is off, the *Rerun Architectural* will not allow the front panel to be locked. Set the front panel lockout enable option as desired.
4. Release the number 10 [SHOW] button.
5. Press the [PAUSE] button to save the new settings and to resume the show.

Note:

- The front panel lockout enable feature is a global system parameter. Although it can be accessed from any show, there is only one front panel lockout enable state.
- By default, the front panel cannot be locked.
- See the Front panel lockout section in the LOCKING THE FRONT PANEL section for operational details.

EDITING SHOW PARAMETERS (CONTINUED)

Grand master

A grand master feature is available as a factory option. This feature allows the user to alter the overall level output of the current show. The REWIND and FORWARD buttons are used to access this feature while the show is running. The REWIND button raises the grand master and the FORWARD button lowers it.

Note:

- The grand master feature can only be enabled at the factory. It cannot be enabled in the field.
- The grand master feature is disabled by default.
- When enabled, the grand master feature does not alter the levels of the incoming DMX512 levels.

LIMITED MANUFACTURER'S WARRANTY

Products manufactured by Doug Fleenor Design (DFD) carry a five-year parts and labor warranty against manufacturing defects. It is the customer's responsibility to return the product to DFD at the customer's expense. If covered under warranty, DFD will repair the unit and pay for return ground shipping. If a trip is necessary to the customer's site to solve a problem, the expenses of the trip must be paid by the customer.

This warranty covers manufacturing defects. It does not cover damage due to abuse, misuse, negligence, accident, alteration, or repair by other than by Doug Fleenor Design.

Most non-warranty repairs are made for a fixed \$50.00 fee, plus shipping.

Doug Fleenor Design, Inc.

396 Corbett Canyon Road
Arroyo Grande, CA 93420
(805) 481-9599 voice and FAX
(888) 4-DMX512 toll free (888) 436-9512
web site: <http://www.dfd.com>
e-mail: info@dfd.com

