

QolorFLEX[®]

PROFESSIONAL LED LIGHTING

CITY
THEATRICAL
NEW YORK • LONDON

QolorFLEX[®] 24V LED Tapes and QolorFLEX NuNeon[®]

About QolorFLEX

City Theatrical's QolorFLEX® brand of LED Lighting is recognized for its superior quality, versatility, and variety. Created specifically for lighting professionals working in theatrical, television and film, and architectural applications, our goal was to produce a premium product line offering designers a variety of configurations of tape that could be incorporated into their projects easily. Backed by City Theatrical's superior technical expertise and support, QolorFLEX LED Tape is now used on hundreds of productions and in environments across the globe.

In addition to the original QolorFLEX LED Tape, the brand now includes a wide array of wired and wireless dimmers, our plug and play QolorPIX® Pixel Controlled LED Tape system, and QolorFLEX NuNeon® linear lighting and accessories – making it the **professional's brand of choice for distinctive, dependable LED lighting products.**



Learn more about QolorFLEX in the overview video at: <https://youtu.be/inPg3uOmpVo>

Ways You'll Benefit

High Quality Products That Work

QolorFLEX products are all professional grade, tested, and trusted. All LED tapes under the QolorFLEX brand are ETL listed and CE and RoHS compliant.



Maximum Creative Potential

We offer a complete line of tape, dimmers, accessories, and more so lighting and scenic designers can maximize their creative vision for a performance or installation.

Easy To Work With

QolorFLEX products are all installation friendly with a variety of mounting and wiring accessories available.

Long Lasting Performance

Our LED Tape products meet or exceed industry standards for service life.

Consistent Color Matching

Our LEDs are binned to assure that your tape will always match if you buy several units together or replace one at a time.

Support When You Need It

The QolorFLEX line is backed by the support and knowhow of the City Theatrical team – the best in the business for over 35 years.

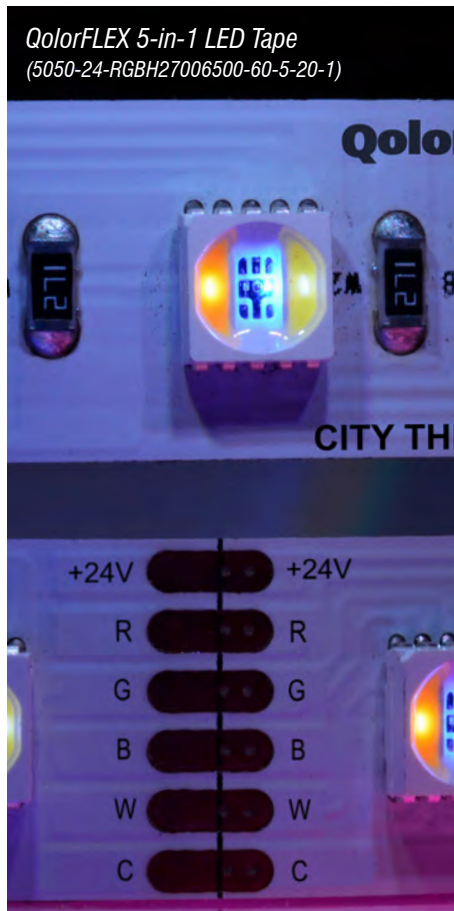

QolorFLEX LED Tape

QolorFLEX LED Tape: Professional Grade Linear Lighting

The QolorFLEX LED Tape line is complete with 40+ types of high quality tape to add to any designer's toolkit. All QolorFLEX LED Tape is ETL listed, and CE and RoHS compliant, and sold in five meter reels with six-inch pigtails soldered on both ends for easy connections to dimmers.



Available in 12 and 24 volt and indoor and outdoor configurations, our white tapes range in color temperature from warm white, at 2700° K, to daylight, at 6500° K. We also offer an adjustable dual white for fine-tuning the color balance, three and four color tapes, like RGB and RGBA, to create thousands of colors, and five color "5-in-1" tape for ultimate color control. Additional QolorFLEX LED Tapes include HiQ High CRI for film and television, and 395 UV.



“We chose QolorFLEX because we knew it would give us the look and flexibility we were going for, and also because we’ve used it for other installations without having to replace it for years.”

- Mark Miskimen, President, ACME Corp. Production Resources, on the Kegnado Lighting Installation at Lakefront Brewery in Milwaukee, Wisconsin

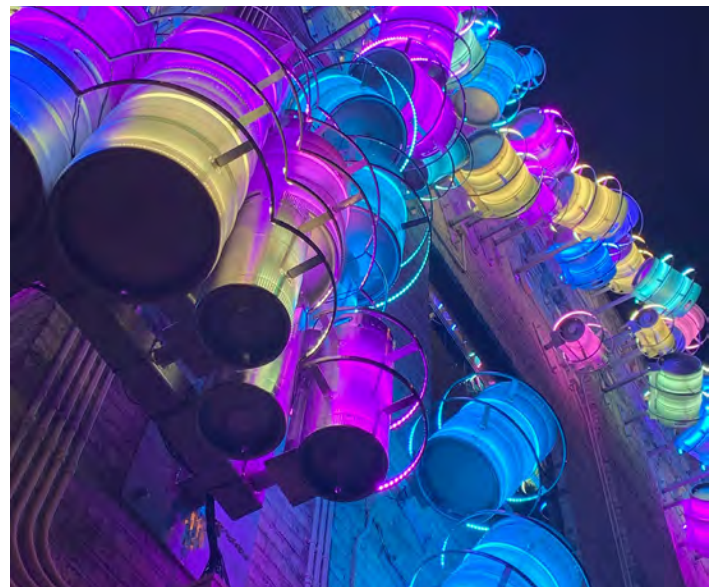

Custom cut QolorFLEX RGB LED Tape and Dimmers at Lakefront Brewery Lighting Package & Installation: ACME Corp. Production | Photo: Mel Miskimen

QolorFLEX NuNeon

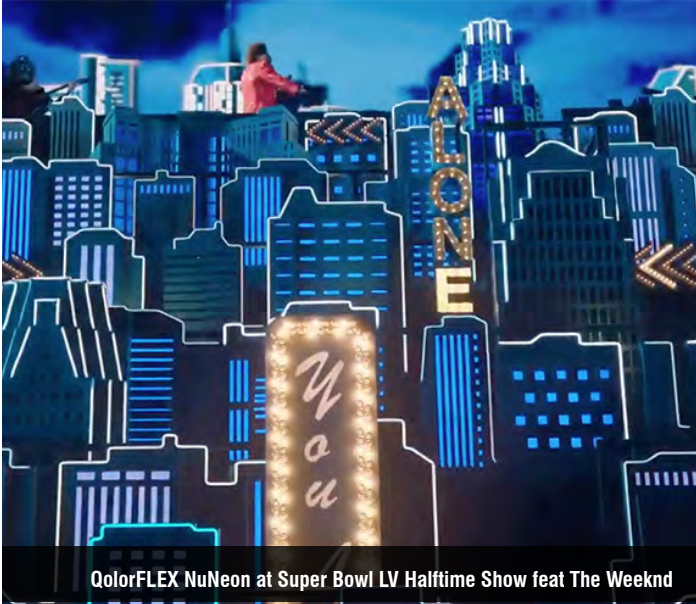

QolorFLEX NuNeon at Super Bowl LV Halftime Show feat The Weeknd

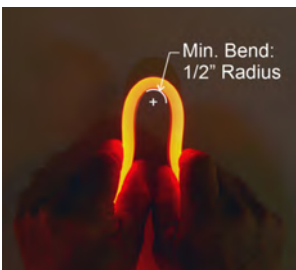

Min. Bend:
1/2" Radius

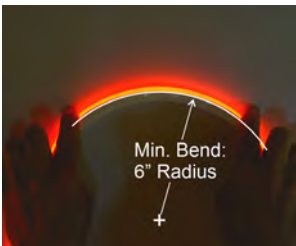

Min. Bend:
6" Radius

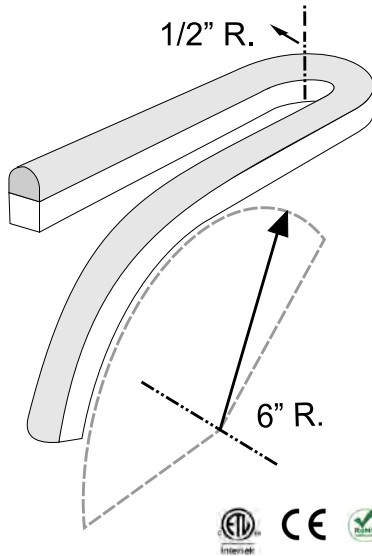

QolorFLEX NuNeon: Extremely Flexible and Bright

QolorFLEX NuNeon is an incredibly flexible and bright sealed LED linear lighting product that can be used to replace traditional neon lighting in entertainment and architectural projects. It was carefully developed to provide lighting and scenic designers with bold and bright accents for their designs.

Each tape has a 12mm (1/2") minimum bending radius, making QolorFLEX NuNeon up to 80% more flexible than similar products on the market today. QolorFLEX NuNeon tape is available in nine vivid colors, including Tunable White HiQ High CRI for film and video projects, RGB, three types of white, and four solid colors. It is IP67 rated for indoor or outdoor use.

QolorFLEX NuNeon can be cut in 50mm (2") increments, and includes 200mm (8") cables on both ends for easy connections. QolorFLEX NuNeon operates on 24VDC and can be powered and controlled by variety of QolorFLEX Dimmers and power supplies.

“QolorFLEX NuNeon’s flexibility is endless. It can be placed and used in different mediums. It functions in a way the artist is happy with, wherever it goes. As a set designer, QolorFLEX NuNeon opened up creativity in many ways.”

- Cort Lawrence, Scenic Designer/Production Coordinator,
Duke Dumont at the Shrine Auditorium



QolorFLEX NuNeon at the Duke Dumont performance at the Shrine Auditorium in Los Angeles, California | Photo by Lucas MK

Learn more about working
with QolorFLEX NuNeon at:
youtu.be/tj4ecRmyCMQ

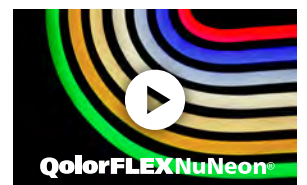

QolorFLEX Dimmers & Accessories

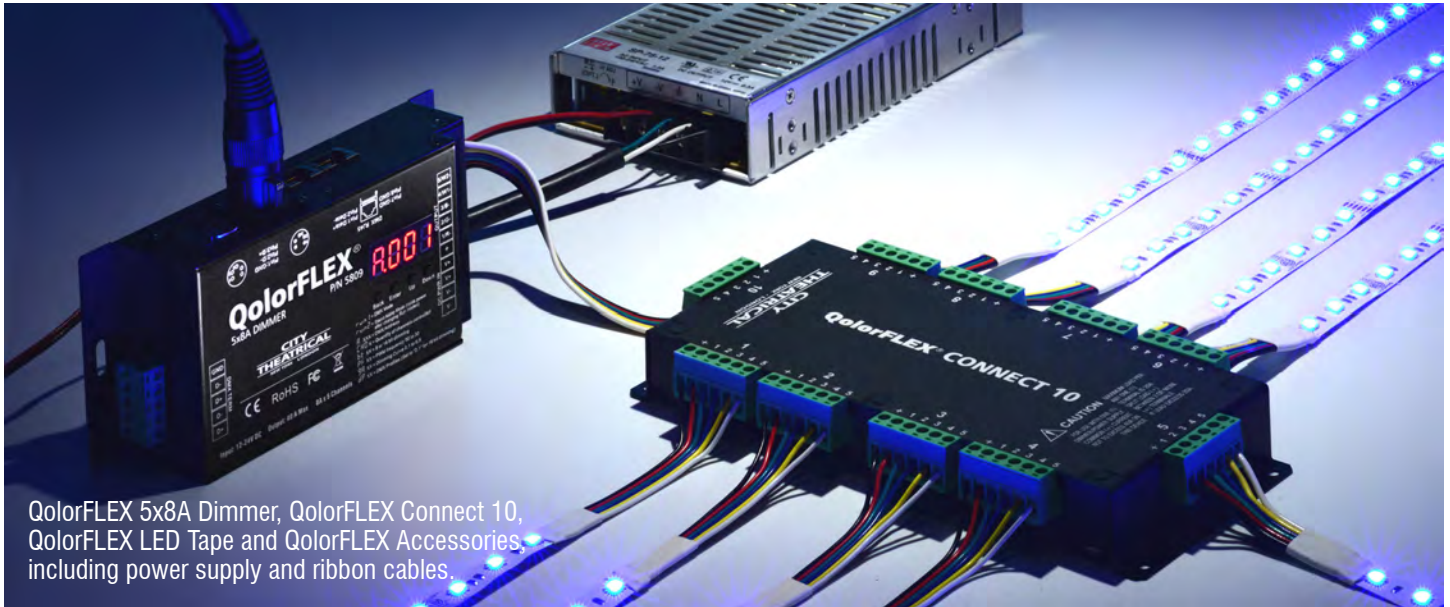

QolorFLEX 5x8A Dimmer, QolorFLEX Connect 10, QolorFLEX LED Tape and QolorFLEX Accessories, including power supply and ribbon cables.

QolorFLEX LED Dimmers

QolorFLEX LED Dimmers pair perfectly with QolorFLEX LED Tape products and are RDM capable. All QolorFLEX Dimmer models (nine wired and three wireless, including QolorFLEX 5x2.5A and 2x2.5A Multiverse® wireless DMX Dimmers) deliver ultra-smooth, flicker-free PWM dimming. They are available in two, three, four, five, and twenty four channel models.

QolorFLEX Accessories

QolorFLEX Accessories, like wire, connectors, extrusions, and power supplies are available and pair perfectly with QolorFLEX Dimmers and LED Tape. QolorFLEX Connect 10 (shown above) is a “plug-in box” that can connect up to nine runs of five, four, three, dual, or single color LED tape to a low voltage low dimmer. Each QolorFLEX Connect 10 uses 10 six position detachable Phoenix terminal block connectors to achieve a quick and well-ordered installation.



QolorFLEX 5x2.5A Multiverse Dimmers (5942) are constant voltage, five-output dimmers that can be controlled wirelessly using City Theatrical's Multiverse wireless DMX.



QolorFLEX 2x2.5A Multiverse Dimmers (5916) are tiny two-channel low voltage dimmers with a Multiverse wireless DMX receiver built in.

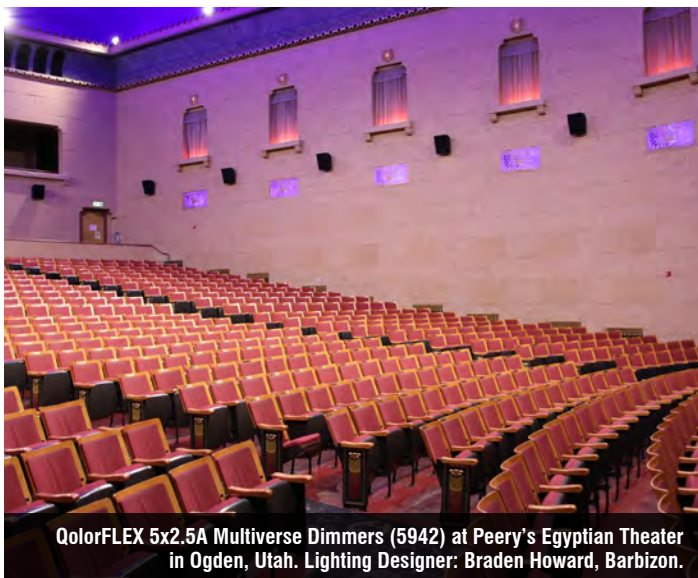

QolorFLEX 5x2.5A Multiverse Dimmers (5942) at Peery's Egyptian Theater in Ogden, Utah. Lighting Designer: Braden Howard, Barbizon.



QolorFLEX Connect 10s & 5x8A Dimmers (5809) at ESPN Studio Y in Bristol, CT Set Design: Jack Morton, Lighting Fabrication: Mystic Scenic Studios

QolorPIX Pixel Controlled LED Tape



QolorPIX Pixel Controlled LED Tape on *The Tonight Show Starring Jimmy Fallon*
Designed by Kelly Hanson | Engineered and Constructed by Rachel Navarro
Photo by Andrew Lipovsky/NBC/NBCU Photo Bank via Getty Images

QolorPIX: Pixel Control Made Simple

While many products on the market offer control of addressable LED tape and fixtures, the process of set up and operation can be challenging. Each QolorPIX Tape Controller is pre-configured with personality profiles that can be combined and adjusted quickly and easily to produce thousands of effects using QolorPIX Pixel Controlled LED Tape products, including chases, fades, scrolls, bursts, and more.

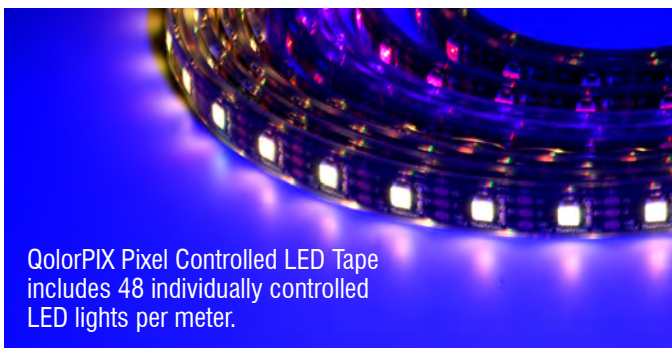

QolorPIX Pixel Controlled LED Tape includes 48 individually controlled LED lights per meter.

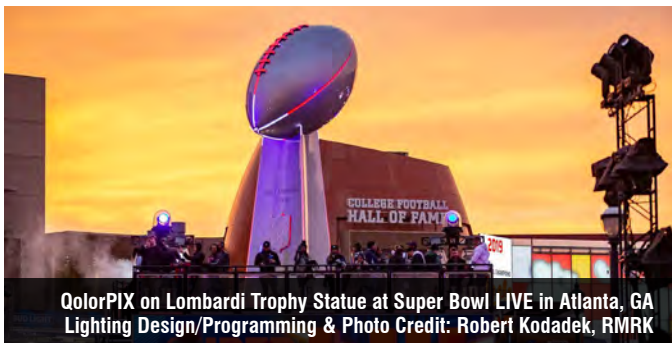

QolorPIX on Lombardi Trophy Statue at Super Bowl LIVE in Atlanta, GA
Lighting Design/Programming & Photo Credit: Robert Kodadek, RMRK

QolorPIX Pixel Controlled LED Tape



QolorPIX Pixel Controlled LED Tape is designed for the most demanding professional applications, with 48 individually controlled LED lights per meter.

Each reel of tape includes a soldered-on four-pin XLR connector on one end, creating a plug and play connection to the QolorPIX Tape Controller. QolorPIX Pixel Controlled LED Tape runs on low voltage (5VDC) and is sold in five meter reels, with a maximum cable connection length (between controller and tape) of 10 meters.

The tape is encased in clear rectangular silicone, making it water resistant (IP 67 rated) for indoor or outdoor use. QolorPIX Pixel Controlled LED Tape is not only ETL listed in the USA and Canada, it is also CE certified in Europe, and RoHS compliant.

“QolorPIX solved many of our challenges – weather, controller distance, brightness – with a single, off-the-shelf solution.”

- Robert Kodadek, Co-Founder & Executive Creative Director, RMRK, on using QolorPIX at the Vince Lombardi Trophy Replica Lighting at Super Bowl LIVE in Atlanta, GA

Visualize and create plug & play effects with QolorPIX at: youtu.be/FaXkXH3QCra



QolorPIX Tape Controller

QolorPIX Tape Controller, Eight Output

The QolorPIX Tape Controller offers eight ports, each accommodating five meters of tape. It has a user-friendly control interface that allows the user to change mode, pixel length, dimmer, personality start address, and direction. It features an integrated power supply, a test function, and flicker finder for easy troubleshooting.

It also offers wireless DMX control using City Theatrical's state of the art Multiverse® technology.

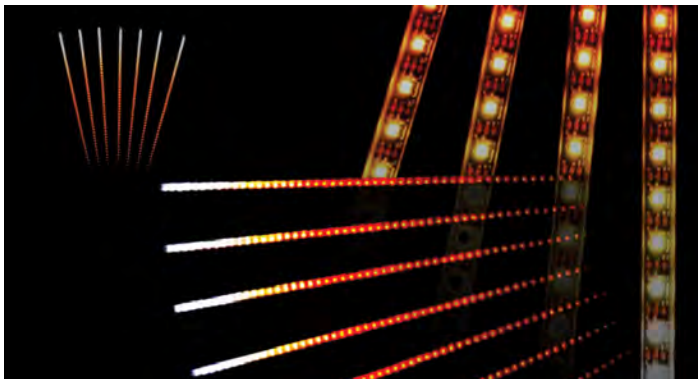



When used in combination with a lighting console, the QolorPIX Tape Controller can easily help you create thousands of dynamic lighting effects - paparazzi, comet, wave, sweep, VU, strobe, and more - in minutes with QolorPIX Pixel Controlled LED Tape.



QolorFLEX LED Lighting at a Glance

QolorFLEX Product Comparison

The best way to get started with the QolorFLEX line is to understand the features of the various products. This QolorFLEX product comparison chart can help you envision how to illuminate your next project.

Product Type	Lighting Effect(s)	Length Per Reel	Operating Voltage	Types Available	Connectors	Additional Information
QolorFLEX LED Tape 	Side wash, diffuse backlight, and edge light	5M (16.4')	12VDC and 24VDC	40+ types; single, dual, tri, quad, 5-in-1, and custom colors available	Six inch pigtails on both ends	All tapes are ETL listed. Indoor and outdoor configurations are available. Indoor styles are self adhesive. Product color is white. Cutting increment varies with type.
QolorFLEX NuNeon 	Bold and vivid continuous diffused colors	RGB and Tunable White HiQ High CRI: 5M (16.4') All other colors: 10M (32.8')	24VDC	Nine colors, including: Tunable White HiQ High CRI, RGB, Red, Green, Blue, Amber, CW, NW, and WW	200mm (8") pigtails on both ends for easy connections	Each tape has a 12mm (1/2") minimum bending radius. It can be cut to length in 50mm (2") increments. IP67 rated for indoor or outdoor use.
QolorPIX Pixel Controlled LED Tape 	Chases, fades, scrolls, bursts, comets - all customizable	5M (16.4')	5VDC	48 individually addressable RGB LEDs per meter	Four-pin XLR on one end	IP67 rated for indoor or outdoor use. Product color is black, encapsulated in clear silicone. Cutting increment is 21mm (0.83").



Attention Designers:

For easy side-by-side comparisons of our QolorFLEX 24V LED Tape products, ask us about our self-contained QolorFLEX 24V Demo Kit.

Call our Sales Team at **201.549.1160** to get started.



CITY
THEATRICAL
NEW YORK • LONDON

www.citytheatrical.com/qolorflex

475 BARELL AVENUE, CARLSTADT, NJ 07072
800.230.9497 OR 201.549.1160 | 201.549.1161 FAX

OFFICE 31, UNITS 1-3, BEVERLEY WAY, NEW MALDEN,
KT3 4PH UNITED KINGDOM | +44 (0) 20 8949 5051