

# SPACIA

OWNER'S MANUAL: CI-MM3-II

## [BOX CONTENTS]

- 1 SPEAKER ASSEMBLY
- 2 GRILLES
- 4 MOUNTING SCREWS
- 2 WIRE NUTS

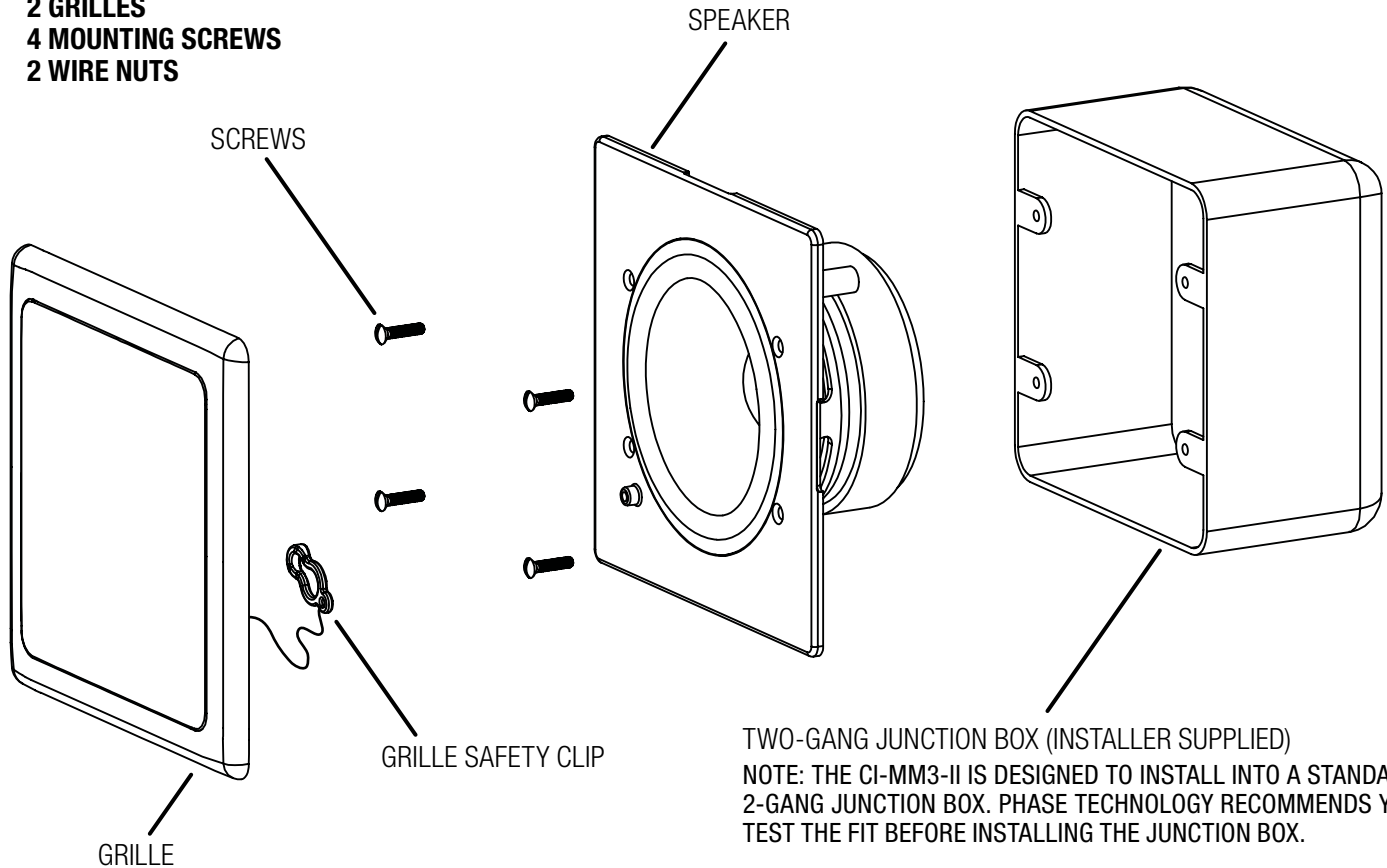

TWO-GANG JUNCTION BOX (INSTALLER SUPPLIED)  
NOTE: THE CI-MM3-II IS DESIGNED TO INSTALL INTO A STANDARD 2-GANG JUNCTION BOX. PHASE TECHNOLOGY RECOMMENDS YOU TEST THE FIT BEFORE INSTALLING THE JUNCTION BOX.

Thank you for choosing Phase Technology® speakers. We know there are a wide variety of choices available today, and we sincerely appreciate your purchase of our product. Phase Technology speakers are built to exacting standards and will provide many years of listening enjoyment.



Our speakers are the result of over five decades of designing and manufacturing. We hold many key patents in loudspeaker technology including the soft-dome tweeter. Our mission, our passion is to constantly advance the art and science of accurate audio reproduction. Our dedication insures your new speakers will accurately reproduce all the impact, detail and delicacy of today's digital technology.

Regardless of application, serious audiophile listening or home theater, we recommend that you take the time to read this manual thoroughly before connecting speakers to your amplifier or receiver. In the highly unlikely event that you should experience a problem with set-up or operation, please contact one of our authorized dealers for assistance, or contact us directly.

Phase Technology® Corporation  
8005 W. 110th St., Suite 208  
Overland Park, KS 66210  
855.663.5600 (Domestic)  
+1.913.663.5600 (International)  
913.663.3200 (Fax)

<b>SAFETY INSTRUCTIONS</b>	<b>2</b>
<b>GETTING STARTED AND PRECAUTIONARY NOTES</b>	<b>3</b>
<b>HOW TO INSTALL YOUR CI-MM3-II SPEAKER</b>	<b>3</b>
<b>CARING FOR YOUR SPEAKERS</b>	<b>3</b>
<b>MAINTENANCE AND SERVICE</b>	<b>4</b>
<b>WARRANTY</b>	<b>4</b>
<b>SPECIFICATIONS</b>	<b>4</b>

## [SAFETY INSTRUCTIONS]

	<b>CAUTION</b> RISK OF ELECTRIC SHOCK DO NOT OPEN	
CAUTION: To reduce the risk of electric shock, do not remove cover (or back). No user-serviceable parts inside. Refer servicing to qualified service personnel.		

### Explanation of Graphical Symbols



The lightning flash with arrowhead symbol, within an equilateral triangle, is intended to alert you to the presence of un-insulated "dangerous voltage" within the product's enclosure that may be of sufficient magnitude to constitute a risk of electric shock to persons.



The exclamation point within an equilateral triangle is intended to alert you to the presence of important operating and maintenance (servicing) instructions in the literature accompanying the appliance.

**1. Read Instructions** - All the safety and operating instructions should be read before the appliance is operated.

**2. Retain Instructions** - The safety and operating instructions should be retained for future reference.

**3. Heed Warnings** - All warnings on the appliance and in the operating instructions should be adhered to.

**4. Follow Instructions** - All operating and other instructions should be followed.

**5. Water and Moisture** - The appliance should not be used near water - for example, near a bathtub, washbowl, kitchen sink, laundry tub, in a wet basement, or near a swimming pool, etc.

**6. Carts and Stands** - The appliance should be used only with a cart or stand that is recommended by the manufacturer.

### PORTABLE CART WARNING



**7. Wall or Ceiling Mounting** - The appliance should be mounted to a wall or ceiling only as recommended by the manufacturer.

**8. Ventilation** - The appliance should be situated so that its location or position does not interfere with its proper ventilation. For example, the appliance should not be situated on a bed, sofa, rug, or similar surface that may block the ventilation openings; or placed in a built-in installation, such as a bookcase or cabinet

that may impede the flow of air through the ventilation openings.

**9. Heat** - The appliance should be situated away from heat sources such as radiators, stoves, or other appliances that produce heat.

**10. Power Source** - The appliance should be connected to a power supply only of the type described in the operating instructions or as marked on the appliance.

**11. Power Cord Protection** - Power supply cords should be routed so that they are not likely to be walked on or pinched by items placed up or against them, paying particular attention to cords at plugs, convenience receptacles, and the point where they exit from the appliance.

**12. Cleaning** - The appliance should be cleaned only as recommended by the manufacturer.

**13. Nonuse Periods** - The power cord of the appliance should be unplugged from the outlet when left unused for a long period of time.

**14. Object and Liquid Entry** - Care should be taken so that neither objects fall nor liquids spill into the inside of the appliance.

**15. Damage Requiring Service** - The application should be serviced by qualified service personnel when:

- the power supply cord or the plug has been damaged,
- objects have fallen onto or liquid has been spilled into the appliance,
- the appliance has been exposed to rain,
- the appliance does not appear to operate normally or exhibits a marked change in performance, or
- the appliance has been dropped or the cabinet damaged.

**16. Servicing** - The user should not attempt to service the appliance beyond those means described in the operating instructions. All other servicing should be referred to qualified service personnel.

**17. Grounding or Polarization** - Precautions should be taken so that the grounding or polarization means of an appliance is not defeated.

### APPLICABLE FOR USA, CANADA OR WHERE APPROVED FOR USAGE

**CAUTION:** TO PREVENT ELECTRIC SHOCK, MATCH WIDE BLADE PLUG TO WIDE SLOT, INSERT FULLY.

**ATTENTION:** POUR EVITER LES CHOCS ELECTRIQUES, INTRODUIRE LA LAME LA PLUS LARGE DE LA FICHE DANS LA BORNE CORRESPONDANTE DE LA PRESE ET POUSSER JUSQU'AU FOND.

## [GETTING STARTED AND PRECAUTIONARY NOTES]

For proper connection and therefore full enjoyment of your new Phase Technology® speakers, we encourage you to read this owners' manual thoroughly, even if you are very familiar with installing speakers.

Speaker placement is very subjective. When deciding upon a location, consider the following:

Make certain your speaker wires can be run to or are accessible from these locations and that the wall or ceiling material is sturdy enough to support the weight and vibration of the speakers. Make certain the area behind the speaker is free of obstacles such as wallstuds, electrical wiring, pipes, etc. Each speaker should be positioned properly, relative to the listening area for good coverage.

## [HOW TO INSTALL YOUR CI-MM3-II SPEAKER]

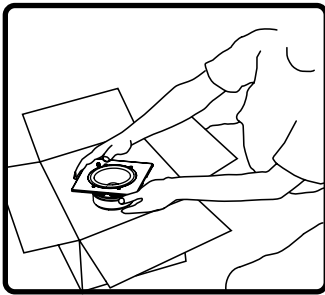

1. Unpack your speaker.

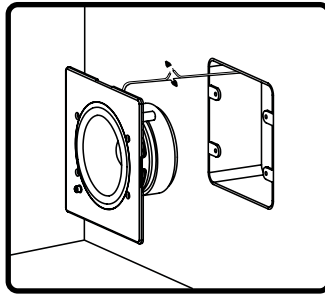

2. Connect speaker wires to signal wires using included wire nuts.

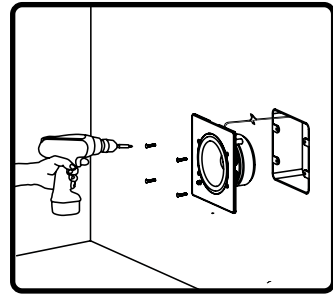

3. Install the CI-MM3-II into the installer supplied junction box using included fasteners.

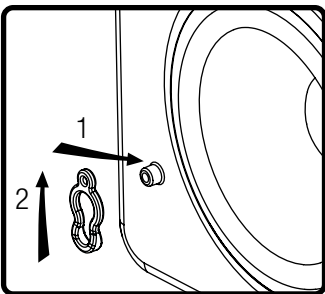

4. Attach grille safety clip by placing the large end of the clip over snap-fit post (1), then sliding clip into small end snaps into place around post (2).

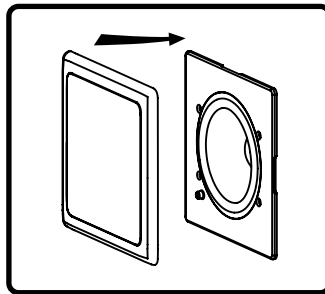

5. Align tabs on snap-fit grille with slots in baffle, gently press grille into place.

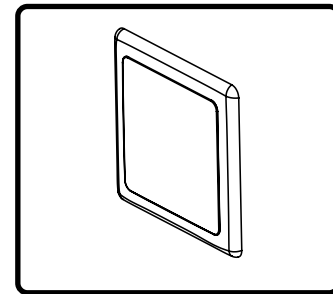

6. DONE!

## [CARING FOR YOUR SPACIA® SPEAKER]

Your Spacia® speaker is engineered for both indoor and outdoor use and operations. Random water hitting the speaker will not damage your Spacia® speaker making it ideally suited for placement in close proximity to swimming pools and spas. The HS15 speaker is not intended for use underwater.

Ordinary dust and dirt accumulation will not harm the Spacia speaker. If you wish to clean the pendant speaker, household glass cleaning solution sprayed on a paper towel may be used for light cleanup. For heavier stains, a soap and water solution applied with a rag or sponge should remove the dirt and stains. Avoid spraying the CI-MM3-II speaker with a high-pressure hose.

## [MAINTENANCE AND SERVICE]

Because of Phase Technology®'s uncompromising quality control programs, it's unlikely that your speakers will ever need service if connected and used as outlined in this Owners' Manual. In the unlikely event that a problem does occur, please contact your Phase Technology® dealer. Your dealer has the necessary factory-authorized parts and trained technicians to quickly restore your speaker to its original performance specifications.

## [WARRANTY]

**LIMITED WARRANTY:** Phase Technology® warrants its loudspeakers to be free from defects in material and workmanship for a period of ten (10) years for speaker product, limited lifetime for CI speakers, five (5) years for HS15, and three (3) years for the electronic components to the original purchaser. Purchase must be made from an authorized Phase Technology® dealer.

This warranty does not cover service or parts to repair damage caused by misuse, abuse, damage while in transit, alterations, unauthorized repairs, failure to follow instructions, fire, flood or any other cause beyond the reasonable control of Phase Technology®. Defects in speaker cabinets or grilles must be brought to the attention of your dealer immediately after purchase. This warranty will be void if the products' serial number has been altered or removed.

Should your Phase Technology® product require service, please call the MSE Audio® customer service department for a return authorization. All merchandise returned to Phase Technology® without prior authorization will be refused. For your return authorization number, please call 855.663.5600 or email sales@mseaudio.com.

## [SPECIFICATIONS]

<b>CI-MM3-II</b>	
<b>Description:</b>	3" Compact, Full-Range In-Wall
<b>Nominal Impedance:</b>	8Ω
<b>Sensitivity:</b>	88 dB
<b>Frequency Response:</b>	75 Hz - 22 kHz
<b>Recommended Power:</b>	5 - 60 Watts
<b>Tweeter(s):</b>	N/A
<b>Midrange:</b>	N/A
<b>Woofer(s):</b>	3" Polypropylene w/ NBR Surround
<b>Inputs:</b>	Screw Terminals
<b>Grille:</b>	White & Aluminum Powder-Coated Aluminum (Fits Standard Dual Gang Box)
<b>Dimensions:</b>	4.125" H x 4.125" W x 1.9" D
<b>Cutout Dimensions:</b>	2.875" H x 3.5" W
<b>Mounting Depth:</b>	1.875"
<b>Weight:</b>	1.5 lbs
<b>Included Accessories:</b>	2 Fitted Grilles (Almond & White)
<b>Optional Accessories:</b>	Metal Back Box (BB-13-11), Rough-In Bracket (RB-18)



Copyright © 2016 MS Electronics, LLC. All rights reserved. MSE Audio, Phase Technology and PhaseTech are registered trademarks and "Speakers for your Life" is a trademark of MSE Audio, Overland Park, Kansas USA. Phase Technology is part of MSE Audio®. www.phasetech.com.