

# ***SUPER ANALOG Series***

**CS-SA Series - 'Super Analog' Time Fade Stations.**

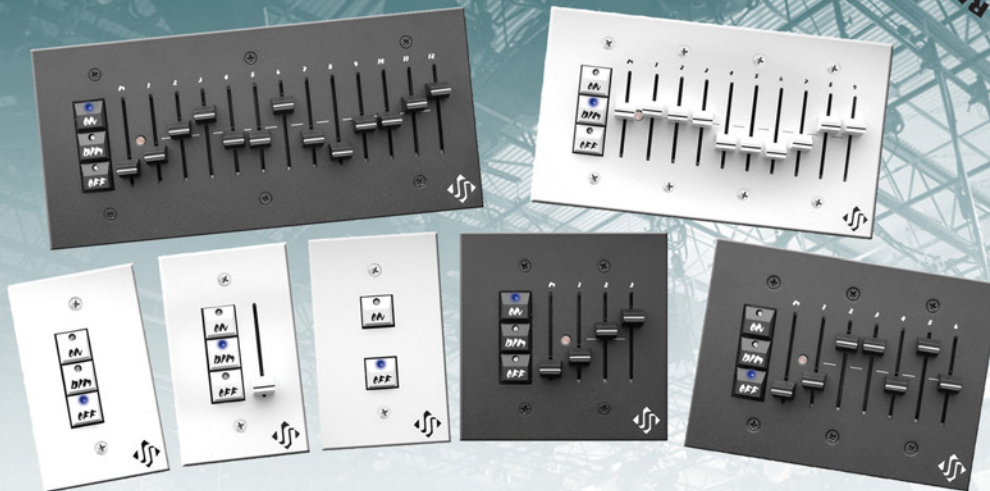

## **Low voltage manual lighting controls for virtually any application!**

The 'Super Analog' series of controls have been developed specifically for control of LED fixtures and next generation fluorescent ballasts requiring 0-10VDC analog control for dimming. Universal in design this series of analog controls is designed to deliver unmatched value in new or retrofit applications. 'Super Analog' controls are a direct replacement for most Johnson Systems CS-2900 Series, Electro Controls analog, Strand Microcontrol® and many other commonly found analog controls.

Available from single to 12 channels with master, preset and take control functions. These universal stations are designed to operate on DC supply voltages up to 24 volts. Their output is digital adjustable from the station for exact control voltage requirements. Adjustable time fade and LED intensity allow customization for demanding applications. Durable powder-coat finish is available in either black or white.



*These products are energy efficient and consume less than 1 watt. Compliance with the International Energy Agency's "One Watt Initiative".*

- ✦ Universal analog control stations for new or retrofit applications.
- ✦ Developed specifically for control of LED fixtures and next generation fluorescent ballasts requiring 0-10VDC analog control for dimming.
- ✦ Direct replacements for most analog control stations.
- ✦ Seven models/sizes available including entrance stations.
- ✦ Digitally adjustable fade-times, voltage output and LED brightness.
- ✦ Electronic "take control" for multiple room/station applications.
- ✦ Multi-mode operation for remote/entrance station lockout.
- ✦ Short-circuit and over-current protection.
- ✦ Ruggedly built for reliability and longevity
- ✦ Tough, durable powder coat paint on 0.80" aluminum laser cut faceplate for a scratch resistant non-glare finish.
- ✦ Color matched and sized for use with Johnson Systems AP Series adapter plates where necessary to adapt to existing (larger) electrical back boxes.
- ✦ Metal shaft sliders and machine screw mounting help prevent broken or missing parts.
- ✦ Heavy-duty "high tactile" pushbutton switches are rated for 5 million operations.



**JOHNSON SYSTEMS INC.**

"PROFESSIONAL LIGHT CONTROL PRODUCTS"

1923 Highfield Crescent S.E.  
Calgary, Alberta, Canada T2G 5M1  
tel: 403.287.8003  
fax: 403.287.9003  
e-mail: [info@johnsonsystems.com](mailto:info@johnsonsystems.com)  
website: [www.johnsonsystems.com](http://www.johnsonsystems.com)

**plasa**  
member

**usitt**

# SPECIFICATIONS

## 1.0 Super Analog - GENERAL





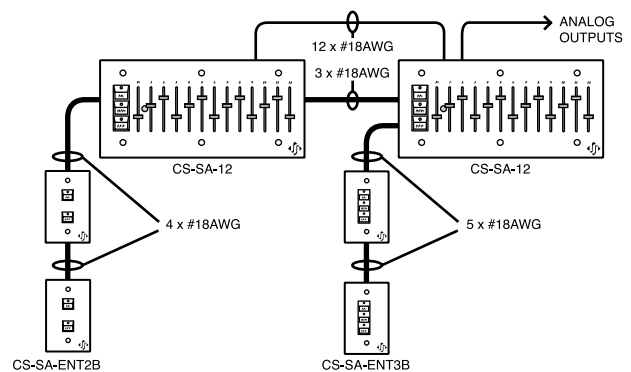

- 1.1 Stations shall be available in single, three, six, nine or twelve channel configurations along with two or three button entrance stations. Backward compatible with all Johnson Systems CS-2900 Series controls.
- 1.2 Control stations shall require flush mounted masonry type back boxes. Such boxes should have a minimum depth of 2.00" and must be grounded (earthed) in accordance with local wiring practice to facilitate a direct discharge path to ground for static electricity. MBD 3" depth back boxes are preferable where possible.
- 1.3 A series of color matched adapter plates shall permit the adaptation of any Super Analog Series control station into any larger standard multi-gang back box up to 6 gangs.
- 1.4 Control station pushbutton switch caps shall be available in either black or white with integral blue LED indicators. These caps shall be clearly identified for pushbutton function. LED intensity shall be adjustable through the full range of operation.
- 1.5 Stations shall operate from a 10.6 - 18VDC regulated supply.
- 1.6 Programmable fade-times from 0 to 60 seconds between station function/preset buttons.
- 1.7 Control station drive capability shall be 50 mA minimum. Stations shall employ both short circuit current limit detection and output overload shutdown with automatic recovery and indication. 100mA short-circuit limit, 0.6W power dissipation with thermal shutoff.
- 1.8 Local and remote lockout modes with indication permit remote/entrance station lockout.
- 1.9 The control station shall be fastened by means of flush mounting 6-32 machine screws. The use of adhesives, magnets, setscrews or tension shall not be considered acceptable for long-term faceplate retention.
- 1.10 Station faceplates shall be fabricated from 0.80" aluminum and shall be supplied in black or white powder coat finish.
- 1.11 Control stations shall employ heavy-duty pushbutton switches, rated at five (5) million operations minimum.

- 1.12 Control stations shall employ metal shaft sliders with a total travel of 45mm (1.75") and black slider knobs. The use of plastic shaft sliders shall not be considered acceptable for resistance to breakage and station longevity.
- 1.13 All control wire terminations shall be via a premium quality "break-away" style screw terminal plug and socket to facilitate ease of station removal while maintaining continuity of power and "take control" to other room stations. For ease of serviceability, it shall be possible to remove any station PCB individually without the need to disconnect any terminated wiring.
- 1.14 All control station channels shall have an output diode to protect against feedback voltage.
- 1.15 All control stations shall employ "auto-resetting" fuse protection on their DC power inputs for protection against voltage spikes.
- 1.16 Circuit board copper plating shall be 1.5 oz. minimum. Circuit board material shall be glass-epoxy with a flame retardant rating of FR-4, 0.062" thickness. All circuit boards shall be solder masked and silk screened with component legends.







Specifications subject to change without notice.

Typical Wiring Riser Diagram



Model	Description	# Wires	Back Box	Minimum PCB Clearance
CS-SA-1-?	 1 gang, single channel manual control w/on, preset, and off	4	1 gang	1.80" W x 2.75" H x 2.00" D 4.6 cm x 7.0 cm x 5.1 cm
CS-SA-3-?	 2 gang, 3 channel manual control w/master slider, on, preset, and off	6	2 gang	3.60" W x 2.75" H x 2.00" D 9.1 cm x 7.0 cm x 5.1 cm
CS-SA-6-?	 3 gang, 6 channel manual control w/master slider, on, preset, and off	9	3 gang	5.50" W x 2.75" H x 2.00" D 14.0 cm x 7.0 cm x 5.1 cm
CS-SA-9-?	 4 gang, 9 channel manual control w/master slider, on, preset, and off	12	4 gang	7.30" W x 2.75" H x 2.00" D 18.5 cm x 7.0 cm x 5.1 cm
CS-SA-12-?	 5 gang, 12 channel manual control w/master slider, on, preset, and off	15	5 gang	9.10" W x 2.75" H x 2.00" D 23.1 cm x 7.0 cm x 5.1 cm
CS-SA-ENT2B-?	 1 gang, 2 button (on/off) entrance station with adjustable "on" voltage for stand-alone applications	5	1 gang	1.80" W x 2.75" H x 2.00" D 4.6 cm x 7.0 cm x 5.1 cm
CS-SA-ENT3B-?	 1 gang, 3 button entrance station w/on, preset, and off	6	1 gang	1.80" W x 2.75" H x 2.00" D 4.6 cm x 7.0 cm x 5.1 cm

### Wiring Termination

	COM	DC Low Voltage Common
	V+	10.6 - 18 Volt DC Supply
	RST	Reset Take Control For Remote "OFF"
	DIM	Dim Take Control For Remote "DIM"
	ON	Full On Take Control For Remote "ON"
	MP	Master Pot Output

"Take Control" of control stations shall require one (1) wire per button function between separate control stations. A maximum of three (3) wires shall be required for all "Take Control" functions (ON, DIM, and OFF).

**NOTE:** ? = B (black) or W (white)  
E.g., CS-SA-6-B



**JOHNSON SYSTEMS INC.**

"PROFESSIONAL LIGHT CONTROL PRODUCTS"

1923 Highfield Crescent S.E.  
Calgary, Alberta, Canada T2G 5M1  
tel: 403.287.8003  
fax: 403.287.9003  
e-mail: info@johnsonsystems.com  
website: www.johnsonsystems.com

