

# TASCAM

D01405020E

# Portacapture X6

## Linear PCM Recorder

Reference Manual

V2.00

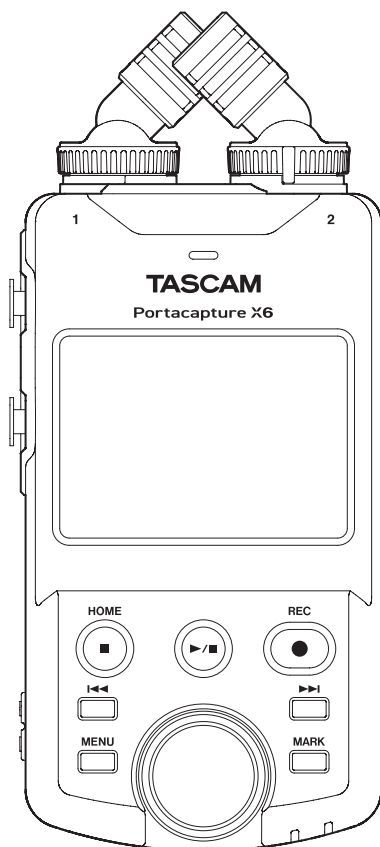

# Contents

1-1	Features .....	4	Adjusting input gain (GAIN) .....	24	
1-2	Conventions used in this manual.....	4	Changing the input gain (GAIN) .....	24	
1-3	Trademarks and copyrights .....	5	5-3 Adding reverb to inputs (REVERB).....	24	
1-4	microSD cards.....	5	5-4 Setting the phantom power voltage.....	25	
	Precautions for use .....	5	5-5 Setting plug-in power .....	25	
	Note about formatting.....	5	<b>6- Recording apps.....</b>	<b>26</b>	
1-5	Accessories sold separately.....	6	6-1 Recording app overview.....	26	
	USB cables (for communication or data transmission) .....	6	Recording pause function.....	26	
	PS-P520U AC adapter .....	6	Recording operation flow .....	26	
	AK-BT1 Bluetooth adapter .....	6	6-2 Button operations during recording .....	27	
<b>2- Names and functions of parts .....</b>	<b>7</b>	6-3 Recording with the ASMR app.....	28		
2-1	Front .....	Screen overview .....	28		
2-2	Bottom .....	Shortcut Menu .....	28		
2-3	Left side.....	Setting input levels.....	28		
2-4	Right side.....	8	6-4 Recording with the MANUAL app.....	29	
2-5	Bottom .....	Recording guide function (MANUAL app only) .....	29		
2-6	Using the wheel.....	Setting procedure.....	29		
2-7	Using the touchscreen .....	Screen overview .....	29		
	Basic screen operations .....	Shortcut Menu .....	29		
	.....	Using the wheel.....	30		
2-8	App overview.....	Setting input levels.....	30		
	LAUNCHER screen.....	Using the mixer.....	30		
	Recording app signal flows .....	11	6-5 Recording with the MUSIC app .....	31	
	Recording app output files .....	12	Screen overview .....	31	
	Project status bar.....	13	Shortcut Menu .....	31	
	Shortcut Menu .....	13	Selecting the type of instrument to record .....	31	
	.....	13	Setting the input level.....	31	
<b>3- Preparation .....</b>	<b>15</b>	Adding reverb to the input (REVERB).....	31		
3-1	Inserting and removing microSD cards.....	15	6-6 Recording with the VOICE app .....	32	
	Inserting microSD cards .....	15	Screen overview .....	32	
	Removing microSD cards.....	15	Shortcut Menu .....	32	
3-2	Preparing the power supply .....	15	Setting the inputs .....	32	
	Notes about power supplies .....	15	Setting the input level.....	32	
	Using AA batteries .....	15	6-7 Recording with the FIELD app .....	33	
	Using an AC adapter (sold separately) .....	16	Screen overview .....	33	
	Using USB bus power .....	16	Shortcut Menu .....	33	
3-3	Turning the power on and off.....	17	Setting the inputs .....	33	
	Turning the power on.....	17	Selecting the recording subject.....	33	
	Turning the unit off (putting it in standby).....	17	Setting the input level.....	33	
	Resume function .....	17	Setting the filter (LOW CUT).....	33	
	Setting the language, date and time .....	17	6-8 Recording with the PODCAST app.....	34	
	Formatting (initializing) microSD cards .....	18	Screen overview .....	34	
<b>4- Connections .....</b>	<b>19</b>	Shortcut Menu .....	34		
4-1	Connection examples .....	19	Using the wheel.....	34	
	Using the MANUAL app.....	19	Setting input levels.....	34	
	Using the PODCAST app.....	19	Using the mixer.....	34	
4-2	Setting the built-in mics .....	19	Making sound pad settings.....	34	
4-3	Connecting external mics and other equipment.....	20	Playing effect sounds during recording .....	35	
	Connecting external mics.....	20	Muting mics .....	35	
	Connecting mid-side mics .....	20	Starting playback .....	35	
	Connecting other equipment .....	20	<b>7- Recording settings .....</b>	<b>36</b>	
4-4	Connecting cameras.....	20	7-1	Monitoring individual inputs (solo monitoring).....	36
	Setting the output for camera use.....	20	7-2	Changing the recording file format.....	36
4-5	Connecting monitoring equipment.....	21	7-3	Recording in mono .....	36
4-6	Using the built-in speaker .....	21	7-4	Pausing during recording (REC PAUSE) .....	36
4-7	Adjusting the playback volume .....	21	7-5	Starting recording automatically (AUTO REC) .....	36
4-8	Connecting computers and smartphones .....	21	7-6	Recording with two settings at the same time (DUAL REC) .....	37
<b>5- Input and output settings.....</b>	<b>22</b>	7-7	Capturing a few seconds before starting recording (PRE REC) .....	37	
5-1	Using the INPUT SELECT function.....	22	7-8	Adjusting input levels automatically (AUTO GAIN) .....	37
5-2	Making input settings for each input.....	22	7-9	Recording file naming.....	37
	Using the STEREO LINK function .....	22	7-10	Designating the folder use for recordings .....	37
	Setting recording input sources (INPUT).....	22	7-11	Changing files while continuing to record (file incrementation function) .....	37
	Using phantom power (phantom voltage).....	22	Automatic .....	37	
	Adjusting the input level automatically (AUTO GAIN).....	22	Manual .....	37	
	Setting the low-cut filter (LOW CUT).....	23			
	Setting the noise gate (NOISE GATE) .....	23			
	Setting the limiter (LIMITER/COMP) .....	23			
	Setting the equalizer (EQ).....	23			
	Inverting the input phase (PHASE INVERT) .....	23			

7-12	Overdubbing and punching in/out (MANUAL app only) .....	37
	Overdubbing .....	37
	Punching in and out.....	38
	Undoing overdubbing and punching in/out (UNDO) .....	38
	Canceling UNDO operations (REDO).....	38
7-13	Recording times (in hours: minutes) .....	39
<b>8</b>	<b>Playing files.....</b>	<b>40</b>
8-1	Opening the playback screen .....	40
	Screen overview .....	40
	Playing and pausing.....	40
	Stopping playback.....	40
	Changing the playback position .....	40
	Selecting files for playback .....	40
	Searching backward and forward.....	40
	Adjusting the mix balance of the tracks .....	40
<b>9</b>	<b>File operations .....</b>	<b>41</b>
9-1	File name overview.....	41
	Changing how files are named .....	43
	Resetting the file number .....	43
9-2	File and project structure overview .....	43
	Folders.....	43
	Recording data.....	43
9-3	Folder hierarchy example.....	43
9-4	Project overview .....	44
9-5	Using the BROWSE screen .....	44
9-6	Folder operations.....	44
	Screen overview .....	44
	Folder menu.....	44
	Creating folders (NEW).....	44
	Changing the names of folders (RENAME) .....	44
	Deleting all files in a folder (ALL FILES DELETE) .....	45
	Deleting folders (FOLDER DELETE) .....	45
9-7	File and project operations .....	45
	File menu.....	45
	SELECT.....	45
	Playing master files(PLAY).....	45
	Viewing file details (FILE INFORMATION).....	46
	Deleting files and projects (FILE DELETE).....	46
	Deleting tracks in projects (TRACK DELETE).....	46
	Enabling and disabling protection (CHANGE PROTECT) .....	46
	Changing names (RENAME) .....	46
	Viewing the mark list (MARK) .....	47
	Dividing files (DIVIDE).....	47
	Normalizing recordings (NORMALIZE) .....	47
9-8	Setting where recording files are saved .....	47
<b>10</b>	<b>Mark functions .....</b>	<b>48</b>
10-1	Mark types.....	48
10-2	Adding marks .....	48
	Adding marks manually.....	48
	Adding marks automatically (AUTO MARK).....	48
	Adding marks when peak levels occur (PEAK MARK) .....	48
10-3	Deleting marks .....	48
	Deleting all marks .....	48
10-4	Jumping to set marks (mark skipping) .....	48
10-5	Dividing files at every mark .....	48
10-6	Opening mark lists.....	48
<b>11</b>	<b>Camera functions .....</b>	<b>49</b>
11-1	Setting the output for camera use.....	49
11-2	Using the automatic slate tone function (AUTO TONE) .....	49
	Setting the AUTO TONE function .....	49
	Adjusting the tone volume.....	49
<b>12</b>	<b>USB connection .....</b>	<b>50</b>
12-1	Connecting with computers .....	50
12-2	Connecting with iOS devices .....	50
12-3	Accessing microSD cards from a computer .....	50
	Exchanging files with computers.....	50
12-4	Using the ASIO driver .....	50
12-5	Using as an audio interface.....	50
	Portacapture X6 USB audio channel assignments.....	50
12-6	Using the unit as a USB mic.....	51
	Inputting sound to the computer using the unit inputs .....	51
	Using the computer output as sound input to this unit.....	51
<b>13</b>	<b>Other functions and apps .....</b>	<b>52</b>
13-1	Mixdown function.....	52
13-2	Using the mid-side decoding function .....	52
	Connection settings.....	52
	Adjusting mid and side levels.....	52
<b>14</b>	<b>Controller app.....</b>	<b>53</b>
14-1	Installing the dedicated controller app .....	53
14-2	Connecting with this unit using Bluetooth.....	53
14-3	Using the dedicated smartphone app .....	53
<b>15</b>	<b>Various settings .....</b>	<b>55</b>
15-1	Adjusting gain differences between built-in mics (mic trim function) .....	55
15-2	XRI function overview .....	55
15-3	Showing various information .....	55
15-4	Resetting the date and time .....	55
15-5	Resetting the language .....	55
15-6	Resetting the unit to its factory defaults.....	55
15-7	Formatting microSD cards .....	55
15-8	Using the automatic power saving function .....	56
15-9	Selecting the power source .....	56
15-10	Setting the AA battery type (BATTERY) .....	56
15-11	Power saving (energy conservation) mode .....	56
15-12	Adjusting the display contrast (CONTRAST).....	56
15-13	MENU.....	57
	GENERAL SETTINGS.....	57
	INPUT SETTINGS .....	59
	Mixer.....	59
	BROWSE.....	59
	INPUT SELECT .....	60
	LAUNCHER.....	60
<b>16</b>	<b>Changes made in firmware version updates.....</b>	<b>61</b>
16-1	The following function have been added or changed since firmware version 1.10.....	61
16-2	The following functions have been added or changed since firmware version 2.00.....	65
<b>17</b>	<b>Messages.....</b>	<b>72</b>
<b>18</b>	<b>Troubleshooting .....</b>	<b>73</b>
<b>19</b>	<b>Specifications .....</b>	<b>75</b>
19-1	Specifications and rated values .....	75
	Recorder specifications.....	75
	Analog audio input ratings.....	75
	Analog audio output .....	75
	USB .....	75
	USB audio.....	75
	Bluetooth device connector.....	75
	Audio performance.....	75
	Recording times (in hours: minutes) .....	75
	Operating system and other requirements.....	76
	Other.....	76
19-2	Dimensional drawings .....	77
19-3	Block diagram .....	78

# 1 - Introduction

## 1-1 Features

- The 2.4-inch color touchscreen, which makes the interface easy to view, enables easy and intuitive operation.
- In addition to basic multitrack recording, apps are ready for a wide range of recording applications, including podcasts, music, interviews, field recording and ASMR.
- With 2 lockable XLR input jacks, recording with multiple mic/line inputs is possible. Separate phantom power (24V/48V) is supported for each channel.
- The mic units use high-quality condenser mics.
- Switching between X-Y and A-B recording formats is possible by rotating the mic units.
- Multitrack recording with 6 tracks (4 tracks and a stereo mix) is possible.
- Recording with resolutions up to 96 kHz/32-bit float (floating-point arithmetic) is supported. This enables audio editing using DAW software without reducing the audio quality of the recorded data.
- Dual recording with different formats is possible for each input track.
- USB audio interface functions support 6 ins and 2 outs.
- By connecting an AK-BT1 Bluetooth adapter (sold separately), wireless remote control using a smartphone or tablet can be enabled.
- Recording functions include low-cut filter, compressor, limiter, automatic gain control and noise gate.
- CAMERA and MIC/EXT IN jacks are built-in. These support output from a camera of the sound it is recording, wireless mic receivers and plug-in power mics, for example.
- The CAMERA/LINE output jack has an attenuation function and allows audio output to cameras and other devices.
- Audio can be monitored using the headphone output or the built-in speaker.
- Supports microSD/microSDHC/microSDXC (up to 512 GB) recording media
- Equipped with a USB Type-C port that supports USB bus power Supports operation on USB bus power.
- Various mark functions and an automatic slate tone function are available.

## 1-2 Conventions used in this manual

The following conventions are used in this manual.

- “microSD/microSDHC/microSDXC memory card” is sometimes abbreviated as “microSD card”.
- Smartphones, tablets and other devices connected to this unit using Bluetooth are called “Bluetooth devices”.
- Files created during a single recording are referred to collectively as a project.
- The project that is currently selected is called the “current project”.
- Information shown on a computer display is written like this: “OK”.
- References to “iOS” in this document also include “iPad OS”.
- As necessary, additional information is provided under TIP, NOTE and CAUTION headings.

### TIP

These are tips about how to use the unit.

### NOTE

These provide additional explanations and describe special cases.

### CAUTION

Failure to follow these instructions could result in damage to equipment or lost data, for example.

### CAUTION

Failure to follow these instructions could result in injury.

## 1-3 Trademarks and copyrights

- TASCAM is a registered trademark of TEAC Corporation.
- microSDXC Logo is a trademark of SD-3C LLC.



- MPEG Layer-3 audio coding technology licensed from Fraunhofer IIS and Thomson.
- Supply of this product does not convey a license nor imply any right to distribute MPEG Layer-3 compliant content created with this product in revenue-generating broadcast systems (terrestrial, satellite, cable and/or other distribution channels), streaming applications (via Internet, intranets and/or other networks), other content distribution systems (pay-audio or audio-on-demand applications and the like) or on physical media (compact discs, digital versatile discs, semiconductor chips, hard drives, memory cards and the like). An independent license for such use is required. For details, please visit <http://mp3licensing.com>.
- Microsoft and Windows are either registered trademarks or trademarks of Microsoft Corporation in the United States and/or other countries.
- Apple, Mac, macOS, iOS, iPad, iPadOS and iTunes are trademarks of Apple Inc. in the United States and other countries. The iPhone trademark is used under license from Aiphone Co., Ltd.
- App Store is a service mark of Apple Inc.
- Lightning is a trademark of Apple Inc.
- IOS is a trademark or registered trademark of Cisco in the U.S. and other countries and is used under license.
- Android and Google are trademarks of Google LLC.
- ASIO is a trademark and software of Steinberg Media Technologies GmbH.



- Other company names, product names and logos in this document are the trademarks or registered trademarks of their respective owners.

**Information is given about products in this manual only for the purpose of example and does not indicate any guarantees against infringements of third-party intellectual property rights and other rights related to them. TEAC Corporation will bear no responsibility for infringements on third-party intellectual property rights or their occurrence because of the use of these products.**

**Properties copyrighted by third parties cannot be used for any purpose other than personal enjoyment and the like without the permission of the right holders recognized by copyright law. Always use this equipment properly. TEAC Corporation will bear no responsibility for rights infringements committed by users of this product.**

## 1-4 microSD cards

A microSD card is necessary to record and play files with this unit. Prepare one for use.

This unit can use microSD cards that are Class 10 or higher and compatible with microSD, microSDHC or microSDXC standards.

A list of microSD cards that have been confirmed for use with this unit can be found on the TASCAM website.

[https://tascam.jp/int/product/portacapture\\_x6/docs](https://tascam.jp/int/product/portacapture_x6/docs)

You can also contact TASCAM customer support.

### Precautions for use

microSD cards are delicate media.

In order to avoid damaging microSD cards, take the following precautions when handling them.

- Do not leave them in extremely hot or cold places.
- Do not leave them in extremely humid places.
- Do not let them get wet.
- Do not put things on top of them or twist them.
- Do not hit them.
- Do not remove or insert them during recording, playback, data transmission or other access.
- Always put memory cards in cases when transporting them.

### Note about formatting

microSD cards formatted by this unit are optimized to improve performance during recording. Use this unit to format the microSD cards to be used with it. Errors might occur when recording with this unit using a microSD card formatted by a computer or other device.

# 1 - Introduction

---

## 1-5 Accessories sold separately

---

This product does not include the following items.  
Please purchase any that you need for your uses.

---

### USB cables (for communication or data transmission)

A USB cable must be prepared to connect this unit to a computer (Windows/Mac) or smartphone.

This unit has a USB Type-C port.

Prepare a USB cable suitable for the USB port of the computer or smartphone being used.

- USB cables designed only for charging cannot be used.

#### Connecting to an iOS device with a lightning port

A genuine Apple Lightning to USB Camera Adapter and a commercially-available Type-A to Type-C cable are necessary.

#### Connecting to a computer or smartphone with a USB Type-C port

A commercially-available Type-C to Type-C cable is necessary.

#### Connecting to a smartphone with a USB micro-B port

A commercially-available micro-B to Type-C cable is necessary.

#### Connecting to a computer with a USB Type-A port

A commercially-available Type-A to Type-C cable is necessary.

---

### PS-P520U AC adapter

This is necessary to operate this unit using AC power.

#### NOTE

This unit does not have a battery charging function when using an AC adapter.

---

### AK-BT1 Bluetooth adapter

This is necessary to control this unit from a smartphone or tablet using Bluetooth connection.

## 2- Names and functions of parts

### 2-1 Front

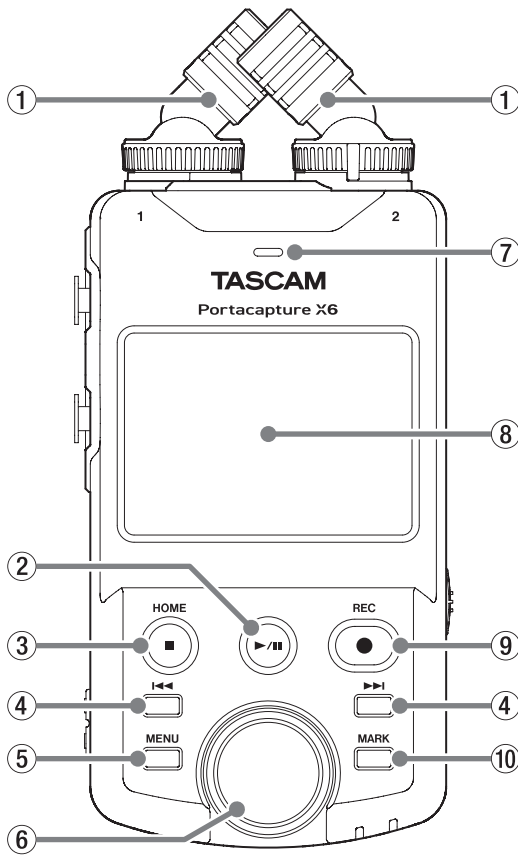

#### ① Built-in mics (Input 1/2)

This is a stereo pair of electret condenser mics. They can be switched between X-Y and A-B recording formats. (“Setting the built-in mics” on page 19)

#### ② ►/|| button

Press when stopped to start playback.  
Press during playback to pause.  
Press when a file is selected on the Browse Screen to play that file.

#### ③ HOME [■] button

Press during playback to stop playback and set the playback position to the beginning of that file.  
Press this when recording or paused to stop recording and return to the HOME screen.  
When the GENERAL SETTINGS screen is open, press this to return to the LAUNCHER screen.

#### ④ ◀◀/▶▶ buttons

#### ⑤ MENU (shortcuts) button

When stopped, this opens the Shortcut Menu on the Home Screen.

#### ⑥ Wheel

Use this make fine adjustments to mixer fader and input level settings.

#### ⑦ Built-in speaker (mono)

Use this built-in speaker to listen to recordings.  
Sound will not be output from the speaker in the following conditions.

- GENERAL SETTINGS screen > I/O SETTINGS page > SPEAKER item set to OFF
- When not playing back
- When headphones are connected
- When in overdubbing and punch in/out mode

#### ⑧ Touchscreen

This shows a variety of information.

Tap it and swipe it to make settings and operate the unit. (“Using the touchscreen” on page 10)

#### ⑨ REC [●] button

Press when stopped to start recording.

Press when recording to put the unit in recording standby.

The function changes according to the RECORDING GUIDE and REC PAUSE settings. See “Recording operation flow” on page 26 for details.

#### ⑩ MARK button

Press when recording or playing back to add marks manually.

### 2-2 Bottom

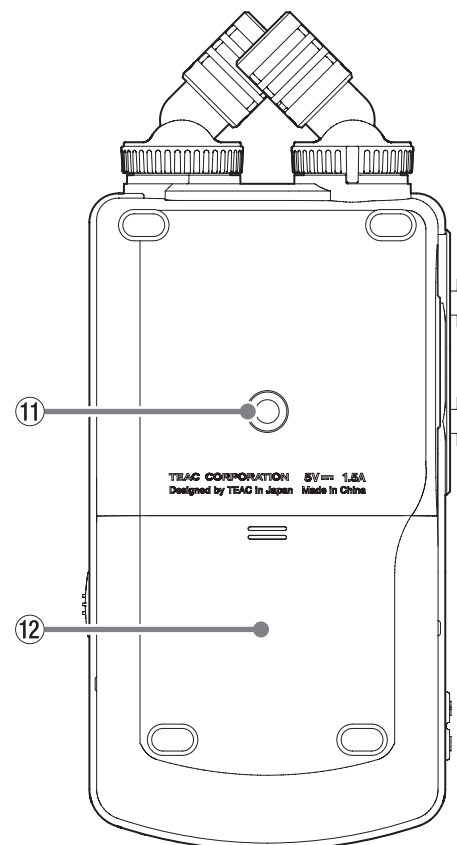

#### ⑪ Tripod mounting threads (1/4-inch)

Use to attach this unit to a tripod.

#### CAUTION

- Ensure the tripod or mic stand screw is securely fastened to prevent the unit from falling.
- When attaching this unit to a tripod or mic stand, be sure to place it on a level surface.
- Some tripods have different screw specifications that make direct connection impossible. Use a commercially-available adapter with such tripods.
- Screws that are longer than 4.5 mm cannot be used for attachment.

#### ⑫ Battery compartment (AA batteries)

Install four AA batteries in this compartment to power the unit.

## 2 - Names and functions of parts

### 2-3 Left side

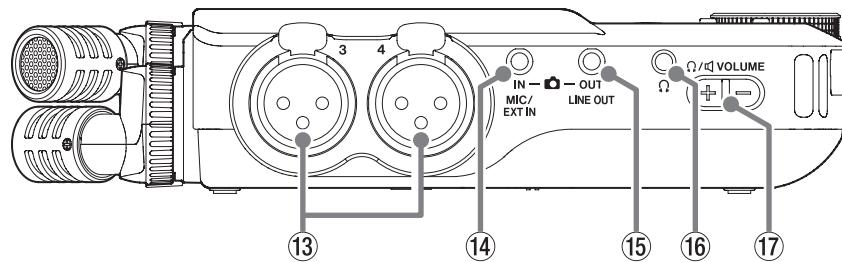

#### ⑬ Input jacks 3/4 (Inputs 3/4)

These analog inputs are balanced XLR jacks.  
XLR (1: GND, 2: HOT, 3: COLD)

#### ⑭ MIC/EXT IN jack

Use a stereo mini jack cable to connect this to the line output jack of an audio device, for example, or an external mic (3.5mm TRS) that supports plug-in power.

#### NOTE

The MIC/EXT IN jack does not have dual ADC. For this reason, suitable gain adjustment is necessary when using the MIC/EXT IN jack. If the analog circuit is overloaded, the entire level meter on the unit screen will become red. Lower the gain so that the level meter does not become red when using it.

#### ⑮ LINE OUT jack

Use this to connect with the line input jack of an amp or other equipment.

#### ⑯ (headphone) jack

Connect headphones to this jack.

#### ⑰ (headphone/speaker) volume

Use this to adjust the volume output from the built-in speaker or the (headphone) jack.

### 2-4 Right side

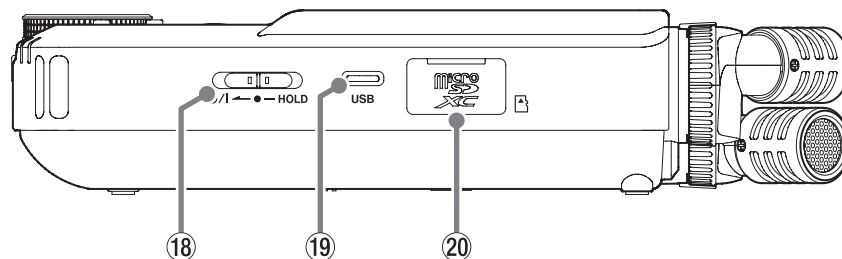

#### ⑱ ⏻/I/HOLD switch

Slide this switch toward the ⏻/I icon to turn the unit on and off (put it into standby). Set it to the HOLD position to activate the hold function. Neither the touchscreen nor any buttons can be used when HOLD is active.

Even when HOLD is active, operation is possible using the remote app (Portacapture Control).

#### ⚠ CAUTION

Before turning the unit on, lower the volumes of connected equipment to their minimum levels.

Failure to do so might cause sudden loud noises, which could harm hearing or result in other trouble.

#### ⑲ USB Type-C port

Use a commercially-available USB cable to connect a computer or smartphone. ("Connecting computers and smartphones" on page 21) When using an AC adapter, connect it to this port. ("Using an AC adapter (sold separately)" on page 16)

#### ⑳ microSD card slot

Insert microSD cards into this slot.



### 2-5 Bottom

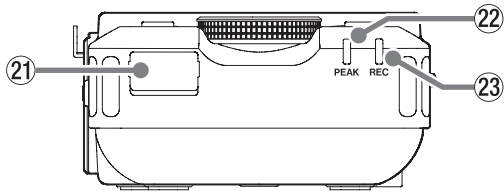

- ②① **Bluetooth adapter connector**  
Connect an AK-BT1 Bluetooth adapter (sold separately) here.
- ②② **PEAK indicator**  
This lights when the input level exceeds the peak level.
- ②③ **REC indicator**  
This blinks when in recording standby and lights when recording.

## 2 - Names and functions of parts

### 2-6 Using the wheel

After tapping a fader or knob on the touchscreen, turn the wheel left or right to change the setting precisely.

This is convenient for precise adjustments after making rough value changes by sliding.

### 2-7 Using the touchscreen

#### Basic screen operations

Functions can be set and adjusted by tapping, swiping and sliding on the touchscreen of this unit.

The first time the unit is started, after setting the language, date and time, the LAUNCHER screen will open.

The LAUNCHER screen can be used to launch various recording apps and setting screens.

#### Launching recording apps

As shown in the illustration below, slide the middle of the screen to select an app to launch, and tap its icon to launch it.



#### Returning to the LAUNCHER screen

1. Press the MENU button at the bottom left of the unit.



2. Tap the LAUNCHER icon in the Shortcut Menu.

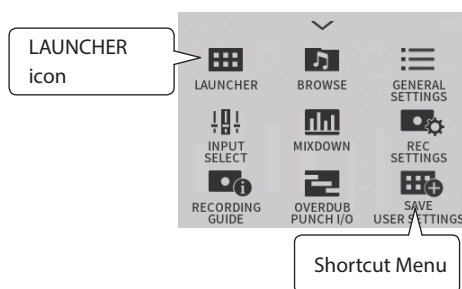

This reopens the LAUNCHER screen.

#### NOTE

When any app screen is open and the unit is stopped, press and hold the HOME button to return to the LAUNCHER screen.

#### Switching screens

Tap the name of a screen on the right of the display to switch to it.

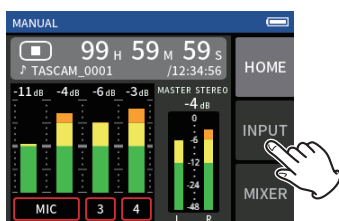

### 2-8 App overview

#### LAUNCHER screen

This can be used to launch recording apps and to open the GENERAL SETTINGS screen.

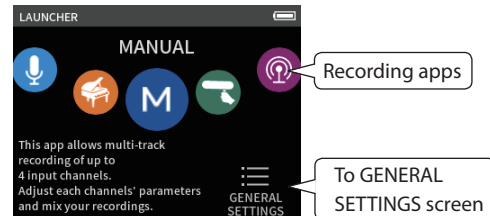

#### Recording apps

The following apps for typical recording situations are available.

ASMR	The screen effect changes in response to the input sound in this recording app. (2-channel recording app)
VOICE	This recording app is good for recording audio for interviews and video blogs. (2-channel recording app)
MUSIC	This recording app is good for easily capturing instrumental and vocal performances. (2-channel recording app)
MANUAL	This is the basic app of the unit. This enables multitrack recording of up to 4 channels.
FIELD	This app is good for recording outdoors. (2-channel recording app)
PODCAST	This app is good for recording podcasts with up to 2 people.

#### Other apps

SD CARD READER	This unit can be used as an SD card reader by connecting it to a computer with a USB cable.
BROWSE	This can be used to select folders and files for playback, deletion and other operations.

#### NOTE

The designs and functions of apps and other features could change with firmware updates.

#### GENERAL SETTINGS screen

Use this to make specific unit settings.

Tap the GENERAL SETTINGS icon at the bottom right of the LAUNCHER screen.

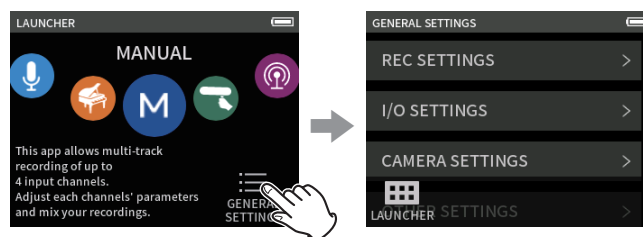

LAUNCHER screen

GENERAL SETTINGS screen

See "GENERAL SETTINGS" on page 57 for a list of setting items.

### Recording app signal flows

This unit is capable of multi-track recording with up to 6 tracks (4 tracks and a stereo mix). In each app, a maximum of 6 inputs can be assigned to up to 6 tracks.

Tracks 1–4 can be used in the MANUAL app, tracks 1–2 can be used in the PODCAST app, and tracks 1 and 2 can be used in 2-channel recording apps.

- The built-in mics and the MIC/EXT IN jack cannot be used at the same time.

#### **M** MANUAL app

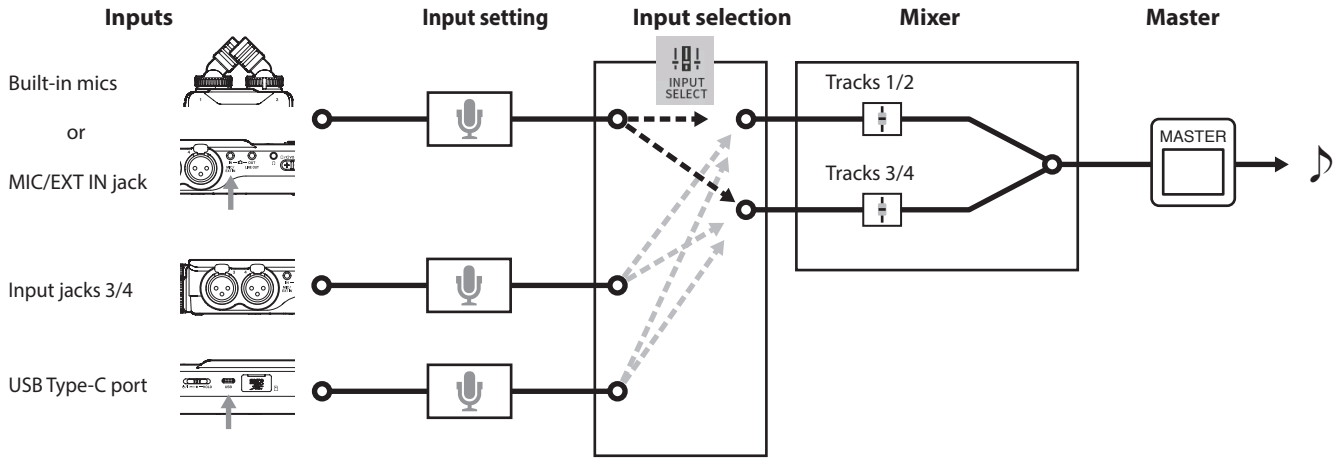

#### ASMR app    MUSIC app    VOICE app

#### FIELD app (2-channel recording apps)

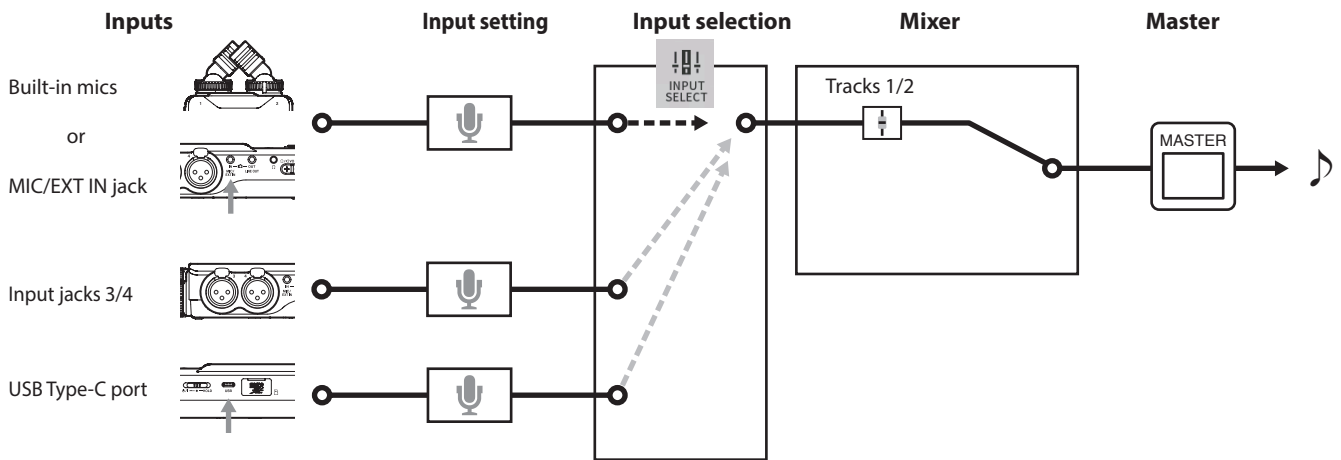

#### PODCAST app

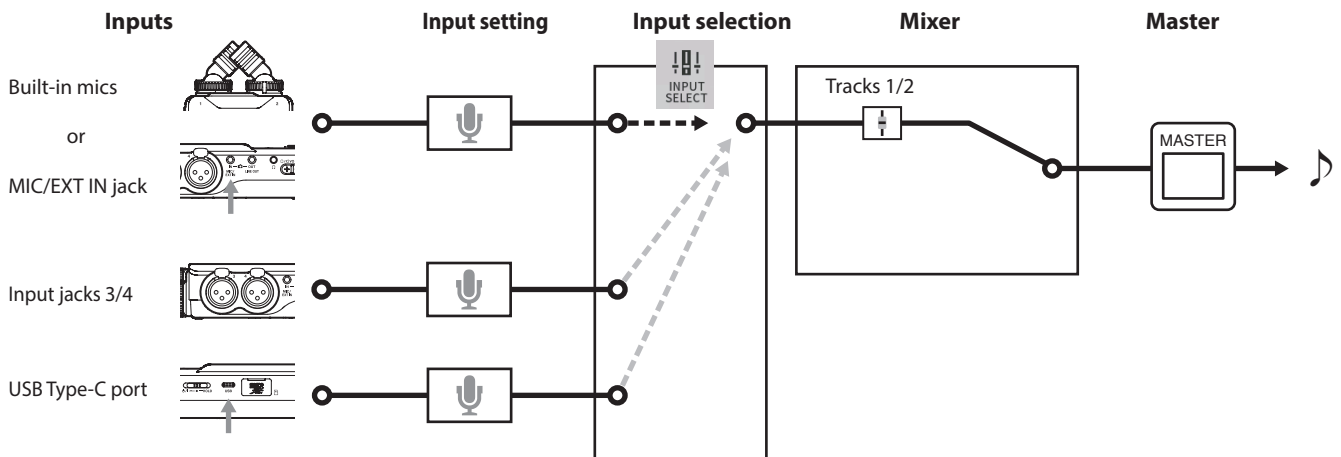

## 2 - Names and functions of parts

### Recording app output files

The types of files produced by recording depend on the app.  
Apps capable of multi-track recording produce a master file as well as track files.

#### **M** MANUAL app

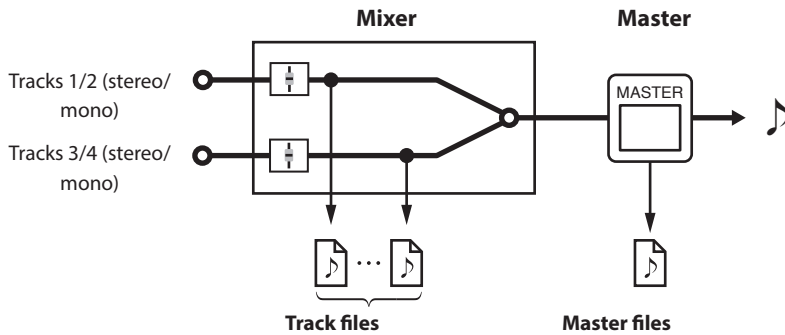

#### **ASMR** ASMR app

#### **MUSIC** MUSIC app

#### **VOICE** VOICE app

#### **FIELD** FIELD app

(2-channel recording apps)

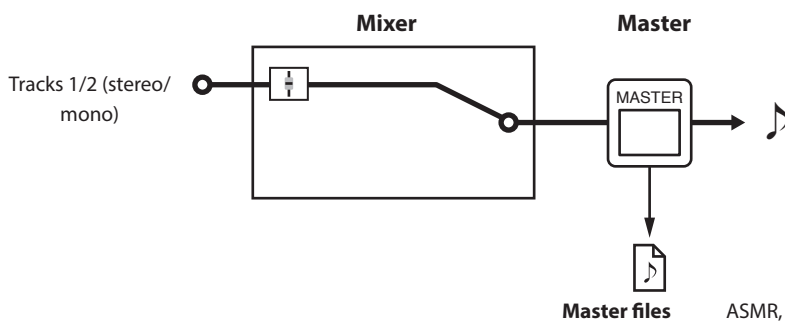

ASMR, MUSIC, FIELD: Stereo files  
VOICE: Mono files

#### **PODCAST** PODCAST app

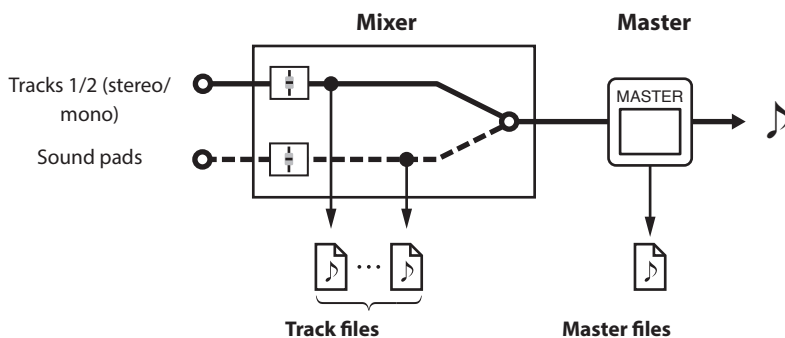

- The PODCAST app cannot use tracks 3–4.

#### Track files

These are mono recording files of audio from each track. Two tracks that are stereo-linked are recorded as single stereo files.

#### Master files

These files are recordings of the mixer output.

### Project status bar

When an app is launched, its HOME screen will show the status of the unit, the counter and other information. In apps that have multiple screens, this data will be abbreviated on screens other than the HOME screen. Tapping the project status bar on the HOME screen will show details.

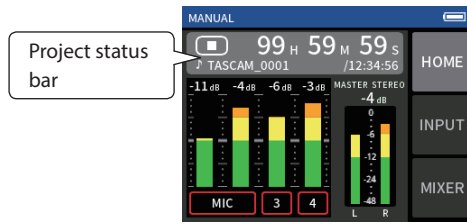

### Showing details

Tap the project status bar to show additional details. When additional details are shown, tap the file format area to restore the normal display.

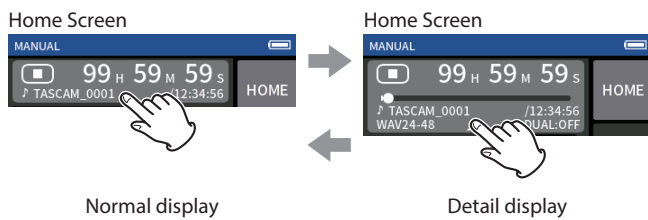

### Information shown

State	Status icon	Counter	File format
Stopped	■	File remaining time/recordable time	According to recording settings
Record	●	Recording time/recordable time	According to recording settings
Recording paused	●	Recording time/recordable time	According to recording settings
Playing files	▶	Playback position/remaining playback time	According to the playback file
Paused		Playback position/remaining playback time	According to the playback file

### Shortcut Menu

Press the MENU Button on the bottom left of the unit to show various menu shortcuts.

ASMR	VOICE	MUSIC	MANUAL	FIELD	PODCAST
LAUNCHER	LAUNCHER	LAUNCHER	LAUNCHER	LAUNCHER	LAUNCHER
BROWSE	BROWSE	BROWSE	BROWSE	BROWSE	BROWSE
REC SETTINGS	REC SETTINGS	REC SETTINGS	REC SETTINGS	REC SETTINGS	REC SETTINGS
INPUT SELECT	INPUT SELECT	INPUT SELECT	INPUT SELECT	INPUT SELECT	INPUT SELECT
INPUT SETTINGS	INPUT SETTINGS				
			RECORDING GUIDE		
			MIX DOWN		
			PUNCH I/O		
GENERAL SETTINGS	GENERAL SETTINGS	GENERAL SETTINGS	GENERAL SETTINGS	GENERAL SETTINGS	GENERAL SETTINGS

## 2 - Names and functions of parts

### Character input

Tap an item for character input to open the character input screen.

The following example shows the character input screen opened from the GENERAL SETTINGS screen > SYSTEM page > FILE NAME > WORD EDIT item.



Press the character type key to switch between letters of the English alphabet and numbers/symbols.

## 3-1 Inserting and removing microSD cards

### Inserting microSD cards

Insert a microSD card into the microSD card slot on the right side to enable playback and recording by this unit.

#### NOTE

microSD cards can be inserted when the unit is on or off.

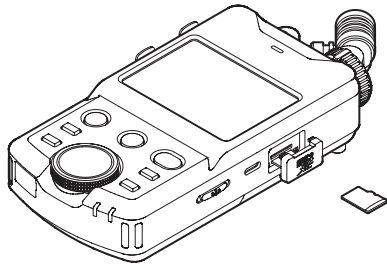

1. Open the microSD slot cover.
2. Insert the microSD card label side up.
3. Close the microSD slot cover.

### Removing microSD cards

Turn the unit off or stop operation before removing a microSD card.

#### CAUTION

Never remove a microSD card when the unit is operating (including recording, playing back, or writing data to the microSD card). Doing so could cause proper recording to fail, data to be lost, and sudden loud noises from monitoring equipment, which might damage the equipment, harm hearing or cause other trouble.

1. Press the microSD card in gently and then release it to allow it to come out.
2. Pull the microSD card out.

## 3-2 Preparing the power supply

### Notes about power supplies

This unit can be powered by 4 AA batteries, a TASCAM PS-P520U AC adapter (sold separately) or a commercially-available USB cable (USB bus power).

Alkaline, Ni-MH or lithium AA batteries can be used.

#### NOTE

This unit does not have a battery charging function when using an AC adapter.

### Using AA batteries

1. Remove the battery compartment cover, and install 4 AA batteries with their ⊕ and ⊖ marks as shown in the battery compartment.
2. Reattach the battery compartment cover.

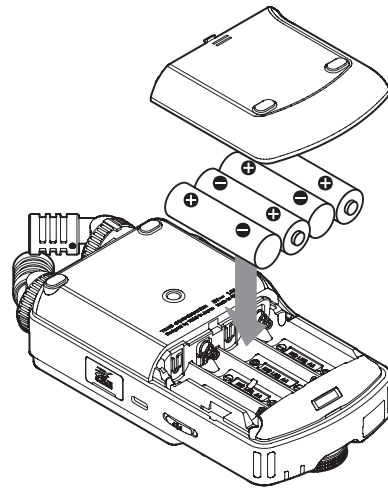

Set the type of battery in order to show the amount of power remaining and allow the unit to determine whether enough power is available for proper operation. ("Setting the AA battery type (BATTERY)" on page 56)

#### NOTE

- The included alkaline batteries are for confirming operation of the unit. For this reason, they might not last very long.
- When using dry cell batteries, the potential operation time will vary according to the environmental temperature and operating conditions. For continuous operation over a long time, we recommend using an AC adapter or other external power supply.

## 3 - Preparation

### Using an AC adapter (sold separately)

Connect a PS-P520U AC adapter (sold separately) to the unit's USB port.

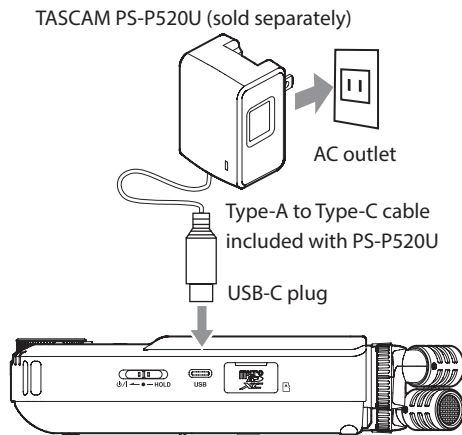

#### CAUTION

- We highly recommend using the AC adapter designed for use with this unit (PS-P520U sold separately). When using another external power supply device, use one with the following specifications.

- Supplied voltage: 5 V
- Supplied current: 1.5A or more

Using a power supply device with specifications other than the above could cause malfunction, overheating, fire or other problems.

If trouble should occur, stop using the unit and contact the retailer where you purchased it or a TASCAM customer support service to request repair.

- Noise may occur when recording with a microphone if the unit is too close to the AC adapter. In such a case, keep sufficient distance between the AC adapter and the unit.

#### NOTE

- If the supplied current of the external power supply cannot automatically be determined, a power supply current confirmation pop-up will appear. If the power supply current is less than 1.5 A, the POWER SAVE MODE will be enabled, restricting some functions. ("Power saving (energy conservation) mode" on page 56)
- If the POWER SOURCE SELECT setting is AUTO, power will be supplied from the external source when both that source and batteries are available.

### Using USB bus power

Use the supplied USB cable to connect the unit and the computer as illustrated below.

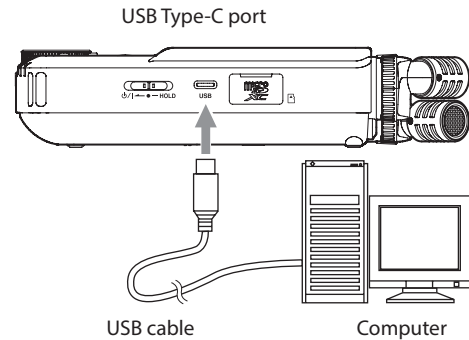

#### NOTE

- If a computer is going to be used only to supply power, a driver does not need to be installed.
- We recommend connecting it to a USB Type-C port on a computer or other device.
- If the current supplied by USB cannot automatically be determined, a power supply current confirmation pop-up will appear. If the power supply current is less than 1.5 A, the POWER SAVE MODE will be enabled, restricting some functions. ("Power saving (energy conservation) mode" on page 56)



### 3-3 Turning the power on and off

#### CAUTION

Turn down the volume of the sound system connected to the unit before starting up or shutting down the unit.

Do not wear connected headphones when turning the unit on and off. Noise could damage the headphone driver unit or harm your hearing.

#### Turning the power on

Slide the  $\phi$ /I/HOLD switch toward  $\phi$ /I until the display is activated. Then, release the switch.



Start up screen

When the unit starts up, the touchscreen display becomes active. The first time the unit is started, the LANGUAGE screen will open. From the second time, the Home Screen of the app selected on the LAUNCHER screen when the unit was last turned off will reopen.

#### Turning the unit off (putting it in standby)

Slide the  $\phi$ /I/HOLD switch toward  $\phi$ /I until the display turns off. Then, release the switch.

The unit turns off after it completes its shutdown process.

#### CAUTION

Always use the  $\phi$ /I/HOLD switch to turn the unit off.

If the unit is not able to conduct shutdown procedures properly, recording data, settings and other changes could be lost. Lost data and settings cannot be restored.

#### NOTE

The unit cannot be turned off when it is recording or in recording standby.

#### Resume function

When this unit is turned off, it remembers the position where playback was stopped.

The next time it is turned on, playback can be started from where it was stopped.

#### NOTE

Since the stopped position is saved on the microSD card, it will not be saved if the microSD card is replaced while the power is on.

### Setting the language, date and time

#### Selecting the language

The first time the unit is turned on after purchase, the LANGUAGE screen will open.



1. Swipe the screen vertically to find the desired language.
2. Tap the desired language to set it.

#### NOTE

The language setting can be set again using the GENERAL SETTINGS screen > SYSTEM page > LANGUAGE item.

#### Setting the date and time

After setting the language and whenever the date and time has been reset, the DATE/TIME screen will open to enable setting them.

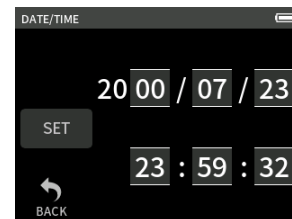

1. Tap and slide the numbers to set the date and time.
2. Tap the SET button to confirm the settings.

#### NOTE

Date and time settings can also be changed using the GENERAL SETTINGS screen > SYSTEM page > DATE/TIME item.

## 3 - Preparation

### Formatting (initializing) microSD cards

The following message will appear if an unformatted card is loaded. Tap OK to start formatting.

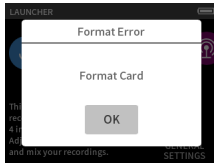

- We recommend using ERASE FORMAT when formatting microSD cards the first time they are used with this unit.
- After formatting completes successfully, the LAUNCHER (app selection) screen will open.

Formatting can also be executed using the GENERAL SETTINGS screen > SYSTEM page > MEDIA FORMAT item.

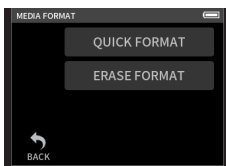

1. Tap QUICK FORMAT or ERASE FORMAT.

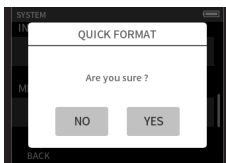

2. Tap YES.

#### **CAUTION**

Formatting will erase all data on a microSD card.  
Back up to a computer, for example before formatting a card.

#### **NOTE**

- Using the ERASE FORMAT option might improve writing performance that has decreased due to repeated use. If "Write error. Recording will continue." or "Card speed reduced. Check BOF mark." appears during recording, format the card using the ERASE FORMAT option.
- ERASE FORMAT checks the memory for errors while formatting, so it takes more time than QUICK FORMAT.

## 4-1 Connection examples

### Using the MANUAL app

Multitrack recording of up to 4 inputs is possible.

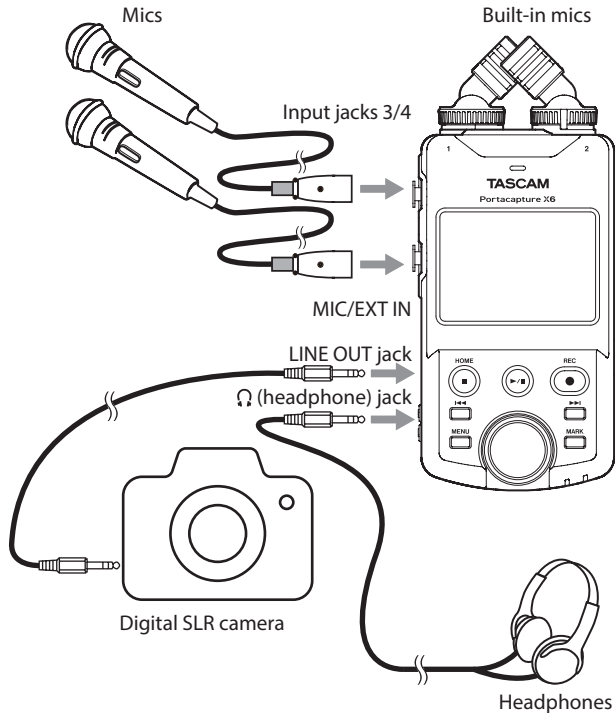

### Using the PODCAST app

Multitrack recording of up to 2 inputs is possible.

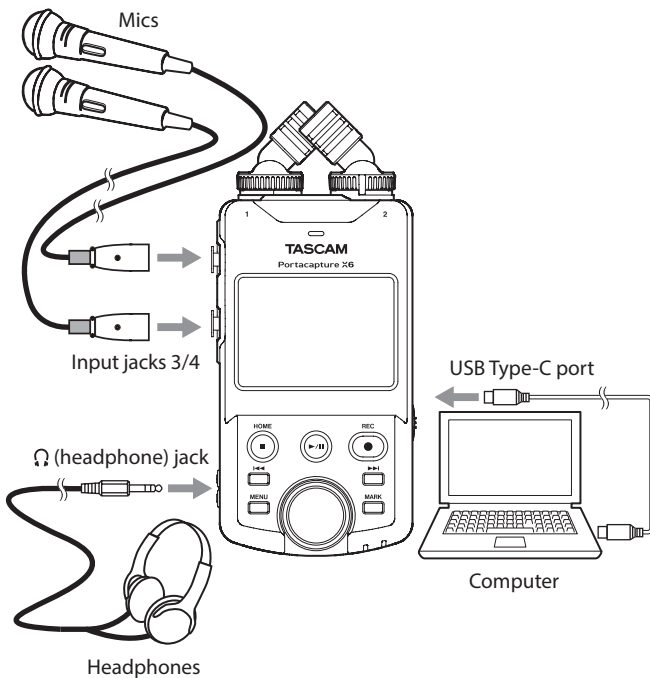

**NOTE**

To use multiple sets of headphones, use a commercially-available multichannel headphone amplifier, for example.

## 4-2 Setting the built-in mics

### Using the built-in stereo mic

This unit's built-in mics are adjustable, enabling the mic format to be changed by setting their angles.

#### True X-Y method

This enables recording with a clear stereo field and reduced phase difference.

#### A-B method

This enables recording with a wide left-right stereo field.

Hold the rings indicated by the black arrows and turn the built-in mics to change their angles.

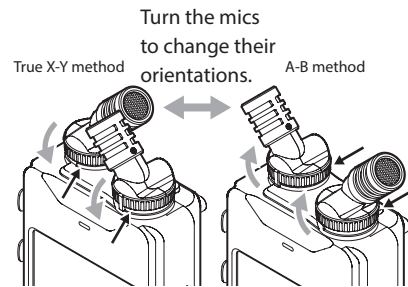

The built-in mics become usable by turning their lock rings until they stop and are tight.

The built-in mics will not be set properly if their rings have not been turned until they stop.

## 4 - Connections

### 4-3 Connecting external mics and other equipment

#### Connecting external mics

Connect mics to the Input 3/4 XLR connectors.

Point the mics at the sound source and place the unit in a stable location where there is little vibration.

When connecting to the XLR jacks, insert the plug until a clicking sound is made. When disconnecting, pull the plug out while pressing the locking mechanism.

Example connecting to input jacks 3-4

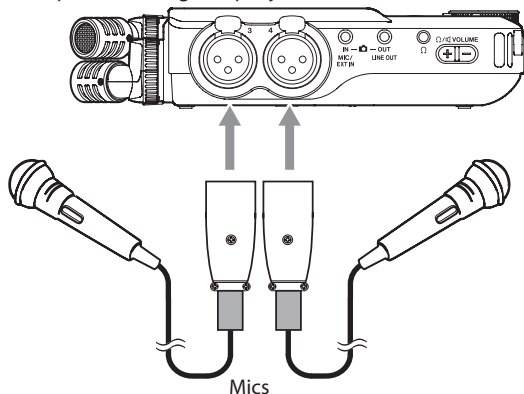

After connecting and making INPUT SELECT settings, use the INPUT settings to select MIC or LINE level. ("Making input settings for each input" on page 22)

#### NOTE

- Make phantom power settings when using a mic that requires phantom power. ("Setting the phantom power voltage" on page 25)
- When connecting a device with unbalanced output, use the MIC/EXT IN jack.

#### Connecting mid-side mics

Mid-side mics can be connected to input jacks 3 and 4.

Connect the mid-side mic mid to input jack 3 and the side to input jack 4. After connecting them, select the tracks assigned to the jacks they are connected to using the GENERAL SETTINGS screen > I/O SETTINGS > MS DECODE > SOURCE item.

See "Using the mid-side decoding function" on page 52 for details about recording with mid-side mics.

#### Connecting other equipment

- Use the MIC/EXT IN jack to connect stereo mini cables. After connecting and making input selection settings ("Using the INPUT SELECT function" on page 22), change the input setting to MIC/EXT IN. ("Making input settings for each input" on page 22)
- To connect XLR plugs, use input jacks 3/4. After connecting and making the INPUT SELECT setting ("Using the INPUT SELECT function" on page 22), change the input setting to LINE. ("Making input settings for each input" on page 22)

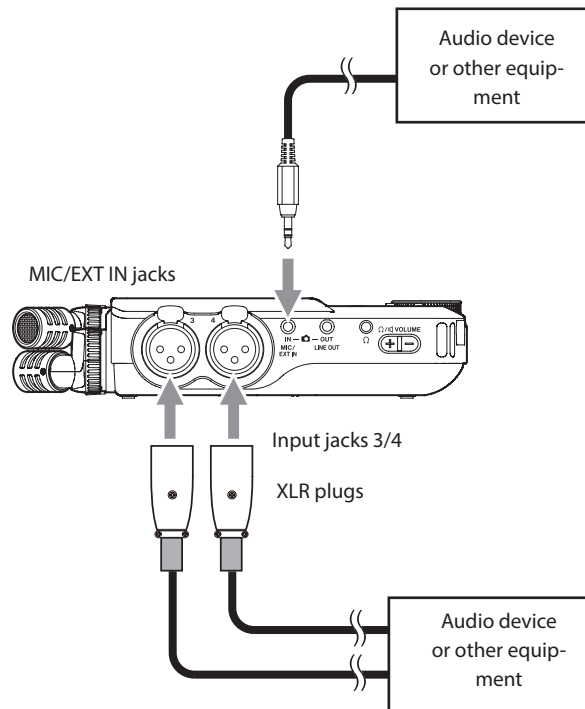

XLR-3-31 equivalent(1: GND, 2: HOT, 3: COLD)

### 4-4 Connecting cameras

When recording video with a camera, the same sound can be recorded simultaneously by the camera and this unit. In order to input sound to the camera, connect it with this device as shown below.

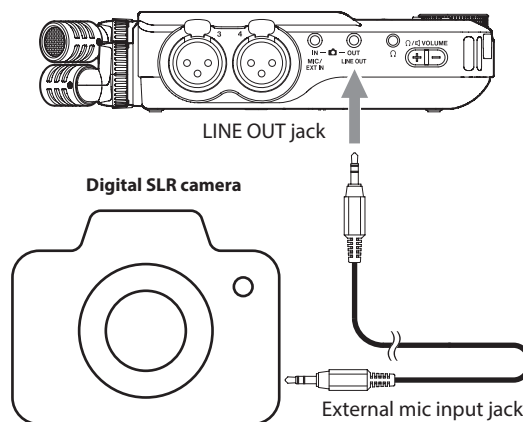

#### Setting the output for camera use

The line output level can be attenuated up to 30 dB for camera use. See "Setting the output for camera use" on page 49.

### 4-5 Connecting monitoring equipment

To listen with an external monitoring system (powered monitor speakers or an amplifier and speakers), connect it to the LINE OUT jack.

To listen with headphones, connect them to the Ω (headphone) jack. Depending on the settings, monitoring might not be possible until the REC [●] button is pushed. See "Recording operation flow" on page 26 for details.

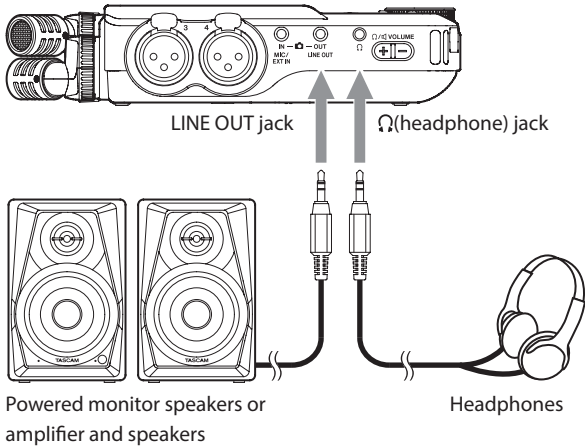

### 4-6 Using the built-in speaker

To listen to the playback sound through the built-in speaker, set the GENERAL SETTINGS > I/O SETTINGS > SPEAKER item to ON.

**NOTE**

If anything is connected to the Ω (headphone) jack, sound will not be output from the speaker even if SPEAKER output is set to ON.

### 4-7 Adjusting the playback volume

Press +/- on the Ω/🔊 (headphone/speaker) volume control to adjust the volume output from the built-in speaker and Ω (headphone) jack.

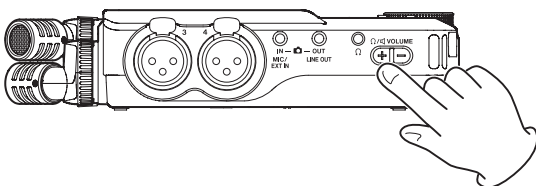

**CAUTION**

To listen to the playback sound through the built-in speaker, set the GENERAL SETTINGS > I/O SETTINGS > SPEAKER item to ON. This is off when shipped new from the factory.

**NOTE**

Sound will not be output through the speaker when the unit is recording, in recording standby, in recording guide mode or when headphones are connected.

### 4-8 Connecting computers and smartphones

The following functions can be used when connected by USB to a computer (Windows/Mac) or smartphone.

- Use the unit as a USB mic
- Simultaneously record to a computer while recording on the microSD card in the unit (backup recording)
- Monitor sound from the computer
- Use as a microSD card reader (only when connected to a computer)

**NOTE**

A USB cable must be prepared to connect this unit to a computer (Windows/Mac) or smartphone. ("USB cables (for communication or data transmission)" on page 6)

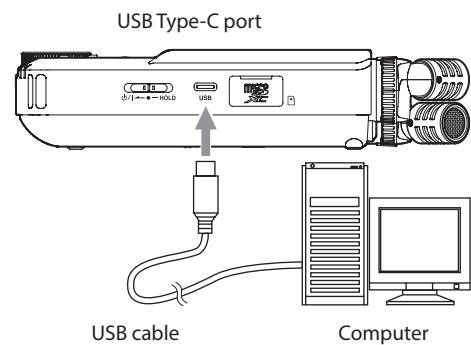

- Stream live mixes of sounds playing back from a computer and input through mics connected to this unit (loopback function)

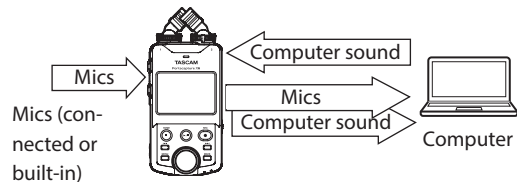

See "USB connection" on page 50 for details about use.

# 5- Input and output settings

## 5-1 Using the INPUT SELECT function

Track numbers and input jacks can be assigned in pairs. The INPUT SELECT function can be used from recording app screens.

1. Press the MENU button at the bottom left of the unit.



2. Tap the INPUT SELECT icon in the Shortcut Menu.

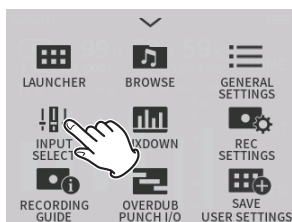

3. Tap a pair of tracks to change their input connector assignments.

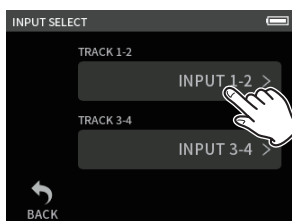

4. Tap the input connector(s) to assign. Repeat steps 3–4 as necessary.

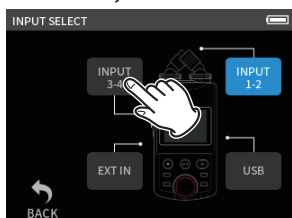

5. Tap the BACK icon to complete the setting.

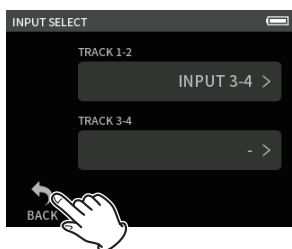

### CAUTION

Since the built-in mic and MIC/EXT IN cannot be used at the same time, only one can be assigned to tracks.

### NOTE

- Input settings are retained by newly assigned tracks. The stereo link function is an exception.
- “MIC” will be shown for tracks that have the built-in mics assigned to them.
- “EXT” will be shown for tracks that have the EXT IN jack assigned to them and “EXT MIC” will be shown if plug-in power is turned on (“Setting plug-in power” on page 25).

## 5-2 Making input settings for each input

Tap the input settings icon of the track to set or INPUT SETTINGS in the shortcut menu to open the settings screen.

MANUAL recording app example

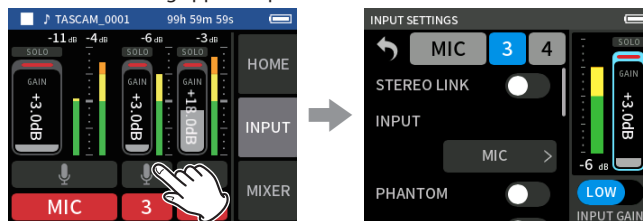

Tap the input settings icon.

### NOTE

- Input settings cannot be made for USB.
- Not all setting items are shown on a single screen. Swipe the screen up and down to show the necessary setting items.
- The tracks that can be set depend on the app. (“Recording app output files” on page 12)
- Even though tracks are selected to make settings, they are saved as settings for the input jacks assigned to those tracks. For this reason, when the INPUT SELECT function is used to change the track assignments of input jacks, the settings do not change for those inputs. The stereo link function is an exception.

## Using the STEREO LINK function

Audio from track pairs 1–2 and 3–4 can be sent to the mixer as stereo. Select one of the tracks to be stereo-linked, and turn the STEREO LINK setting on.

### NOTE

- When shipped new from the factory, the built-in mics are connected to tracks 1–2, which are stereo-linked. “MIC” is shown when the tracks for the built-in mics are stereo-linked.
- Stereo-linking is always on for MIC/EXT IN input and USB input, so the STEREO LINK button is disabled with them.

## Setting recording input sources (INPUT)

Track input sources can be set.

For inputs 1/2, set “MIC” to “EXT”.

For inputs 3/4, set “MIC” to “LINE”.

- When “EXT” is selected, the MIC/EXT IN jack will be assigned with stereo-linking to tracks.
- When “LINE” is selected the input signal is attenuated –22 dB.

## Using phantom power (phantom voltage)

Make this setting when using mics that require phantom power. (“Setting the phantom power voltage” on page 25)

## Adjusting the input level automatically (AUTO GAIN)

When this function is on, the input level will be adjusted automatically in response to the input audio. Using this function, the recording level is automatically increased when the input sound is too quiet or decreased when it is too loud. This function is useful for recording meetings, for example. When AUTO GAIN is on, the recording level cannot be changed manually.

## Setting the low-cut filter (LOW CUT)

This cuts audio below the selected frequency.

The low-cut filter can reduce bothersome noise, such as from wind, air-conditioners and projectors.

Set the cutoff frequency of the low-cut filter to match the noise.

### LOW CUT

OFF(default), 40Hz, 80Hz, 120Hz, 220Hz

## Setting the noise gate (NOISE GATE)

Sound below a set level can be muted.

When LOW is selected, only quite sounds will be muted. When HIGH is selected, sounds up to a certain level will also be muted.

## Setting the limiter (LIMITER/COMP)

Using the limiter can suppress distortion caused by sudden excessive sound input.

### OFF

The limiter function is disabled.

### LIMITER

This function prevents distortion when signals that are too loud are input suddenly.

This is suited for recording live performances and other situations with large volume changes.

### CAUTION

Distortion could occur when the input sound is excessively loud even if the limiter function is on. In such a case, lower the input level or increase the distance between the unit and the source.

### COMPRESSOR

This increases the levels of low-level input signals and adjusts high-level input signals so that they do not become any higher.

This does not have a function to prevent distortion.

This is suited for recording situations that have large volume changes without excessive input levels, for example.

## Setting the equalizer (EQ)

The equalizer has the effect of amplifying and attenuating specific frequency ranges. This can be used, for example, to enhance the sound of individual instruments, to adjust the balance of a wide frequency range and to cut specific unwanted frequencies.

### VOICE

This setting is good for recording sound in interviews, meetings, podcasts and similar conversational situations.

### GUITAR

This setting is good for recording acoustic guitars.

### LOUD

The setting is good for emphasizing heavy low frequencies in band performances, for example.

### VOCAL

This setting is good for recording singing voices.

### MANUAL

With this setting, four bands can be adjusted manually. In addition to low-frequency and high-frequency boosts, two peak curves can be set.

## MANUAL EQ

This 4-band parametric EQ can be adjusted manually.

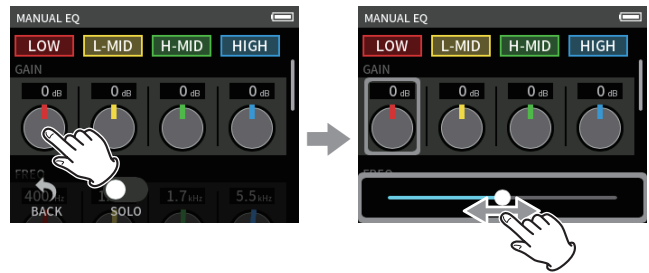

Tap the knob to be adjusted.

Slide the fader left and right to adjust it.

### NOTE

After tapping a knob to adjust it, the wheel can be turned to adjust it precisely.

### GAIN (LOW/L-MID/H-MID/HIGH) knobs

These set the amounts levels are increased or decreased for each band.

Ranges

GAIN: -12 dB – +12 dB (default: 0 dB)

### FREQ (HIGH/H-MID/L-MID/LOW) knobs

These set the cutoff frequencies of the HIGH and LOW bands and the middle frequencies of the HIGH-MID and LOW-MID bands.

Ranges

HIGH: 1.7 kHz – 18.0 kHz (default: 5.5 kHz)

HIGH-MID: 32 Hz – 18.0 kHz (default: 1.7 kHz)

LOW-MID: 32 Hz – 18.0 kHz (default: 1.7 kHz)

LOW: 32 Hz – 1.6 kHz (default: 400 Hz)

### Q (H-MID/L-MID) knobs

These set the acuteness of these bands.

The higher the value is the more acute it becomes, making it affect a narrower frequency band around the set frequency. The lower the value is the less acute it becomes, making it affect a broader frequency band around the set frequency.

Ranges

HIGH-MID: 0.25 – 16.00 (default 2.00)

LOW-MID: 0.25 – 16.00 (default 2.00)

### Examples of EQ characteristics

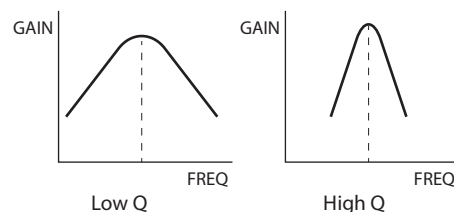
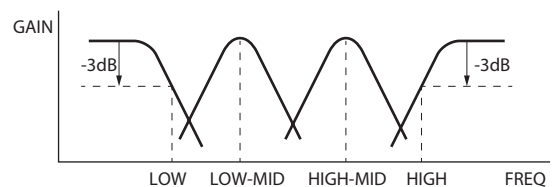

## Inverting the input phase (PHASE INVERT)

Turning this on will invert the phase.

### NOTE

If the sound seems to be unclear when recording the same source with more than two or more mics, inverting the phase of one or more inputs could improve the sound quality.

## 5 - Input and output settings

### Adjusting input gain (GAIN)

Slide the GAIN fader to adjust the input level.

- While watching the level meter, adjust the GAIN so that the level averages around  $-12$  dB and the PEAK indicator does not light.
- The recording sound might distort when the PEAK indicator lights.

#### NOTE

If the input level exceeds  $-2$  dB, the PEAK indicator on the unit will light.



#### NOTE

- If an overload occurs with an analog circuit, the entire level meter will become red.  
Since this could cause the recorded audio to become distorted, make the following adjustments.
  - Change the INPUT GAIN to LOW.
  - Distance the mic from the sound source.
  - Lower the volume of the sound source.
- After tapping the GAIN, the wheel can be turned to adjust it precisely.

### Changing the input gain (GAIN)

The two INPUT GAIN options are LOW and HIGH.

Tap the INPUT GAIN LOW/HIGH button to switch to the other option.

#### NOTE

- Adjust the INPUT GAIN using the LOW setting first. If the gain is insufficient, switch to HIGH and adjust the gain.
- The INPUT GAIN switches of stereo-linked inputs are also linked.
- The INPUT GAIN switches of inputs 1–2 stay linked even when the inputs are not stereo-linked.

### 5-3 Adding reverb to inputs (REVERB)

Set this with the GENERAL SETTINGS screen > I/O SETTINGS page > REVERB item.

When this is on, reverb will be applied to the selected tracks (1/2, 3/4, MIX).

#### NOTE

Reverb cannot be used if the sampling frequency setting is 96 kHz.

#### TYPE

This sets the type of reverb.

TYPE	Effect
LARGE HALL (default)	This reverb is modeled on a large hall space.
SMALL HALL	This reverb is modeled on a small hall space.
ROOM	This reverb is modeled on a small indoor space.
STUDIO	This reverb is modeled on a studio-like space.
PLATE1	This emulates a plate reverb with a large plate.
PLATE2	This emulates a plate reverb with a small plate.

#### SOURCE

Use this to select the tracks affected by the reverb.

When MIX is selected, reverb is applied to the mixer output.

#### LEVEL

This sets the reverb level.



### 5-4 Setting the phantom power voltage

Set the phantom power voltage with the GENERAL SETTINGS screen > I/O SETTINGS page > PHANTOM voltage item.

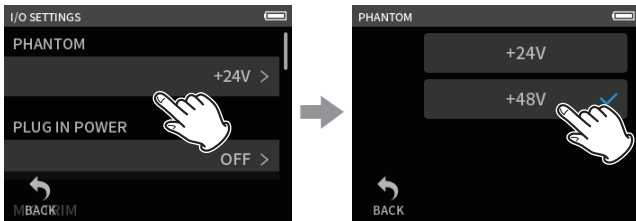

Tap the PHANTOM voltage item

Tap the desired voltage.

#### NOTE

- Turn phantom power output on/off on the INPUT SETTINGS screen. (“Using phantom power (phantom voltage)” on page 22)
- The default value is 48V.
- Battery power will be consumed faster when set to 48V than when set to 24V.

#### CAUTION

- Do not connect or disconnect mics with the MIC/EXT IN jacks when phantom power is on. Doing so could cause a loud noise and might damage this unit and connected equipment.
- Turn phantom power on only when using a condenser microphone that requires phantom power. Turning phantom power on when a dynamic mic or other external device, for example, that does not require it is connected could damage this unit and the connected equipment.
- When using condenser mics that require phantom power and dynamic mics together, be sure to use balanced dynamic mics. Unbalanced dynamic mics cannot be used when phantom power is enabled.
- Supplying phantom power to some ribbon mics could break them. If you are unsure, do not supply phantom power to a ribbon mic.
- Some condenser microphones will not operate when phantom power is set to +24V.
- Battery operation time will change according to the mics being used. For details, refer to the operation manual of the mic, for example.
- When using phantom power while running on batteries, the operation time might be reduced greatly depending on the mics being used. We recommend using a TASCAM PS-P520U AC adapter (sold separately). Furthermore, when using an adapter that does not meet the recommended specifications, supplying phantom power to multiple inputs could cause the power to turn off automatically.
- Do not connect or disconnect the AC adapter when using phantom power. The unit could turn off even when batteries are installed, resulting in recorded data becoming damaged or lost.
- When using USB bus power, the unit might not be able to supply phantom power depending on the computer. In this case, set the unit to use battery power.

### 5-5 Setting plug-in power

Set this with the GENERAL SETTINGS screen > I/O SETTINGS page > PLUG IN POWER item.

Options: OFF (default), ON (STEREO), ON (MONO)

When connecting a microphone that requires plug-in power, set this to ON.

When connecting a mono mic, set this to “ON (MONO)” to record the same signal to both left and right channels.

#### CAUTION

Do not turn plug-in power on when connected to a mic that does not require it. Doing so could damage the connected equipment.

See the mic operation manual for details.

# 6- Recording apps

## 6-1 Recording app overview

### Recording pause function

This unit has a recording pause function that causes it to start monitoring the input signal when the REC [●] button is pressed. This function can be used with all recording apps.

A recording can be started and paused repeatedly without stopping, allowing it to be saved as a single file.

The recording pause function is off when shipped new from the factory.

When the recording pause function is off, the input signal is always monitored when a recording app is active.

When the recording pause function is on, the input signal is only monitored when the recording guide function is active, recording is paused or recording is in progress.

The recording pause function can be set with the GENERAL SETTINGS screen > REC SETTINGS page > REC PAUSE item.

#### NOTE

When the recording pause function is activated monitoring of input signals is disabled when recording is stopped, reducing power consumption.

### Recording operation flow

Depending on the RECORDING GUIDE<sup>1</sup> and REC PAUSE on/off settings, pressing buttons will have the following effects.

RECORDING GUIDE function on REC PAUSE function off

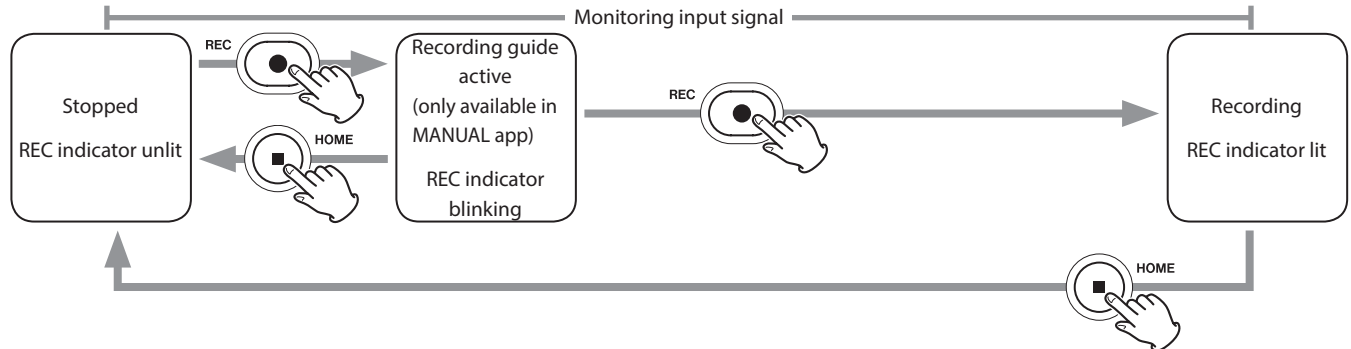

RECORDING GUIDE function on REC PAUSE function on

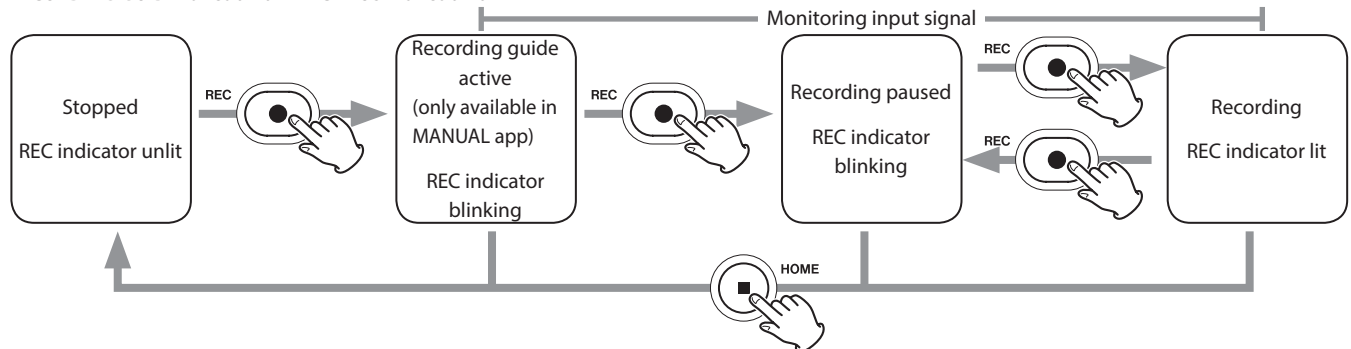

RECORDING GUIDE function off REC PAUSE function off

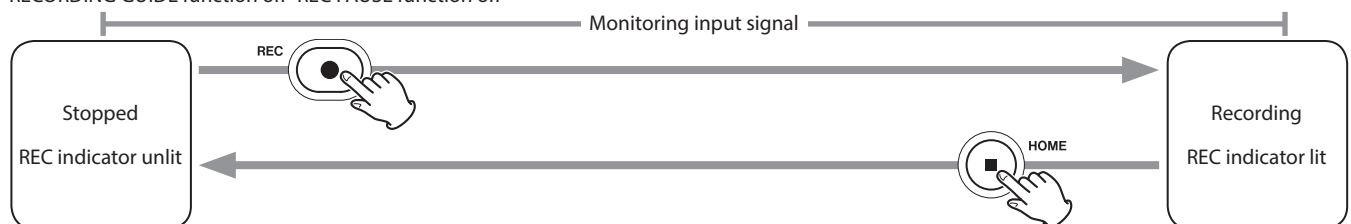

RECORDING GUIDE function off REC PAUSE function on

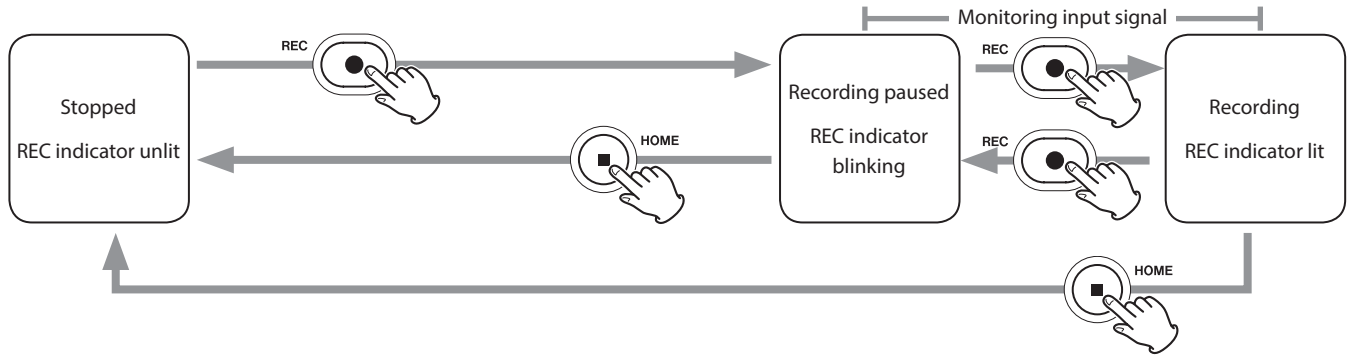

† The recording guide function can only be used with the MANUAL app. With apps other than the MANUAL app, the recording guide function will be disabled regardless of its on/off setting.

## 6-2 Button operations during recording

Recording pause function on

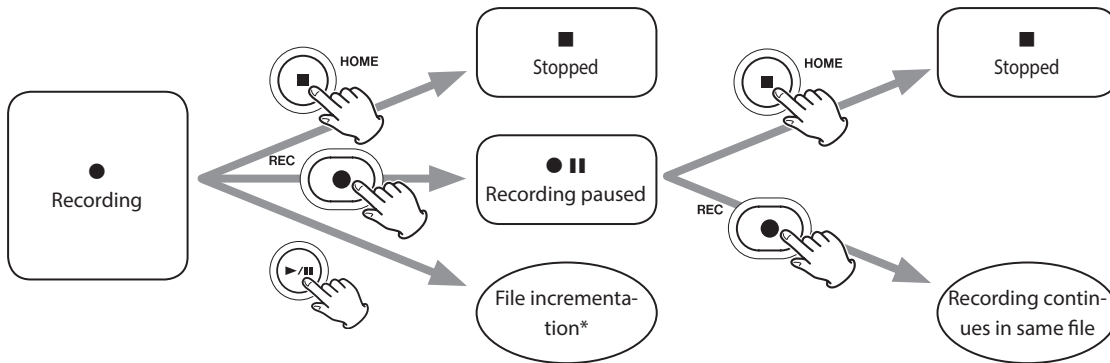

Recording pause function off

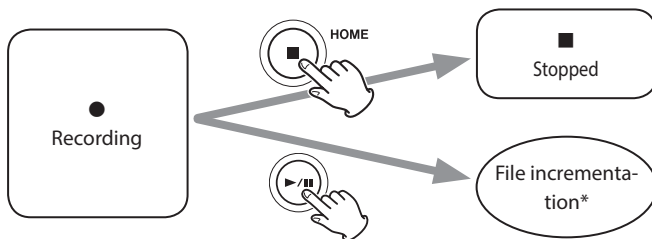

\* See "Changing files while continuing to record (file incrementation function)" on page 37 for information about file incrementation.

## 6 - Recording apps

### 6-3 Recording with the ASMR app

The screen effect changes in response to the input sound in this recording app. To emphasize the sense of stereo, we recommend recording with the built-in mics in A-B format. (“Setting the built-in mics” on page 19)

#### Screen overview

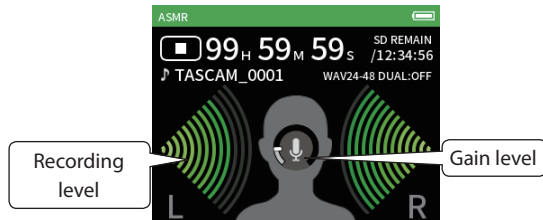

#### Shortcut Menu

Press the MENU button on the bottom left of the unit to show the following menu.

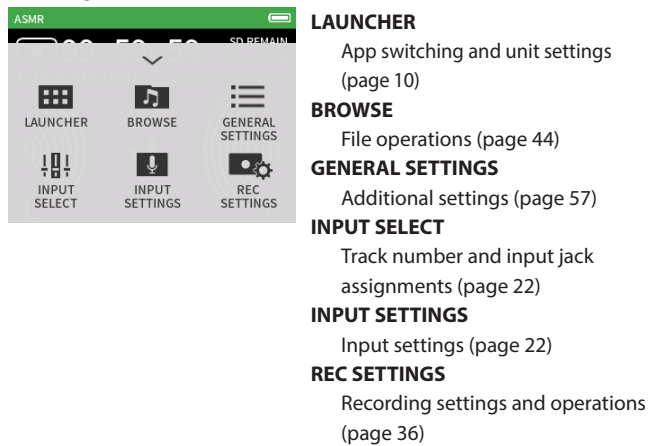

#### Setting input levels

1. Tap the ring in the center of the screen.
2. Bring the mics closer to the recording subject. While checking the level meters, raise the GAIN as high as possible without causing the PEAK indicator to light.

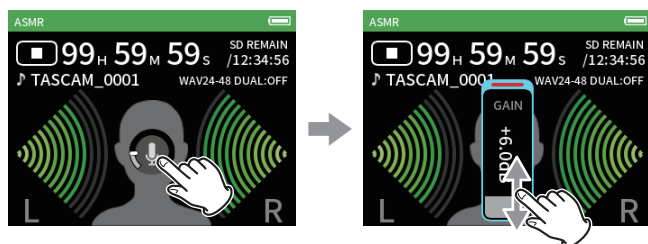

#### NOTE

- If the input level exceeds -2 dB, the PEAK indicator on the unit will light.
- The recording sound might distort when the PEAK indicator lights.
- If the entire level meter becomes red, the analog circuit is overloading.
- After tapping the gain, the wheel can be turned to adjust it precisely.

## 6-4 Recording with the MANUAL app

This is the basic app of the unit. This enables multitrack recording of up to 4 channels.

### Recording guide function (MANUAL app only)

To record, open the recording app shown on the LAUNCHER screen that suits the type of recording. ("App overview" on page 10)

After launching the recording app, the input levels of each track and their mix must also be set in order to record at suitable levels.

This unit has a recording guide function designed to prevent users from accidentally skipping important steps or doing them out of order. This function can only be used with the MANUAL app. (When shipped new the recording guide is on by default.)

After the MANUAL app is launched, operation procedures will be shown. Follow their instructions to make adjustments.

When the recording guide is active, setting screens open for the setting procedure below, enabling settings to be made in the correct sequence.

### CAUTION

No guide related to input and output settings will be shown.

### NOTE

- By default (recording guide activated), recording cannot be started before proceeding through the guided steps to the MIXER screen.
- If the recording guide is not needed, open the MANUAL app Home Screen, press the Shortcut Menu, and turn RECORDING GUIDE off. This enables recording to be started from other screens in addition to the MIXER screen.
- See "Recording operation flow" on page 26 for differences in recording operations when the recording guide function is on or off.
- Even when the recording guide is on, recording can be restarted from the MIXER screen and other screens when recording is paused.

### Setting procedure

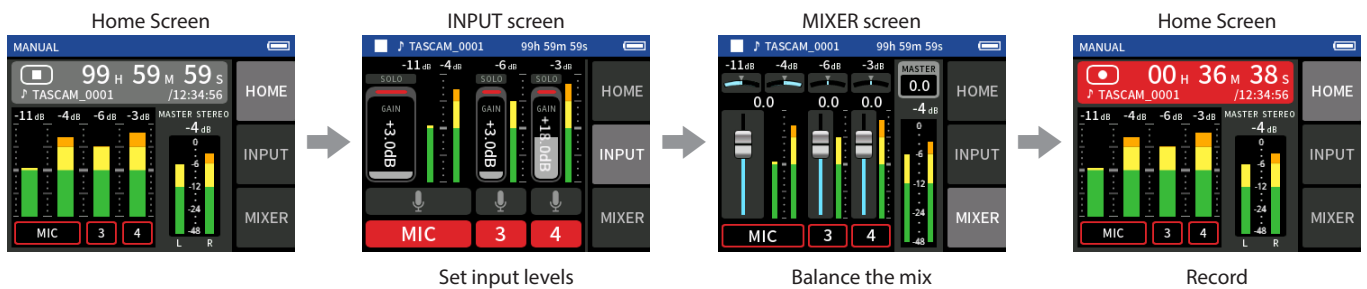

### Screen overview

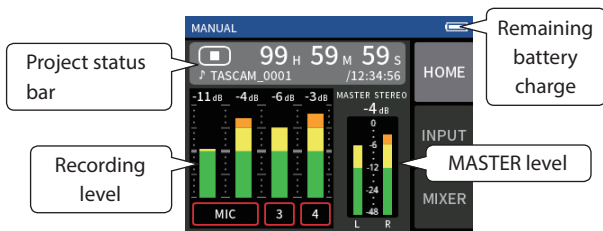

### Shortcut Menu

Press the MENU button on the bottom left of the unit to show the following menu.

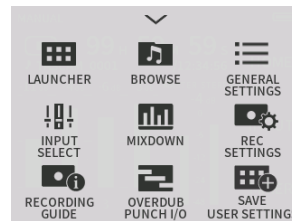

#### LAUNCHER

App switching and unit settings (page 10)

#### BROWSE

File operations (page 44)

#### GENERAL SETTINGS

Additional settings (page 57)

#### INPUT SELECT

Track number and input jack assignments (page 22)

#### MIXDOWN

(page 52)

#### REC SETTINGS

Recording settings and operations (page 36)

#### RECORDING GUIDE

(page 29)

#### OVERDUB PUNCH I/O

(page 37)

## 6 - Recording apps

### Using the wheel

After tapping a GAIN, fader or pan control or the MASTER level, the wheel can be turned left and right to adjust the setting precisely.

This is convenient for precise adjustments after making rough value changes by sliding.

### Setting input levels

1. Open the Home Screen, and press the REC [●] button on the unit. The REC indicator will blink.



When the recording guide mode and recording pause functions are both off, there is no need to press the REC [●] button. ("Recording operation flow" on page 26)

2. Tap the INPUT button on the right side of the screen to open the INPUT screen. Tap MIC, 3 or 4 to turn inputs on and off. When the FILE FORMAT is WAV, tracks that are on will be recorded.

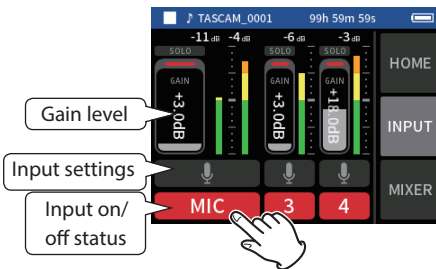

See "Making input settings for each input" on page 22 for details about input settings.

3. While watching the level meters, adjust the GAIN so that they average around  $-12$  dB and the PEAK indicators do not light.

#### NOTE

- If an input level is too low the recorded sound will be quiet, but if it is too high the sound will be distorted (or break up).
- If the input level exceeds  $-2$  dB, the PEAK indicator on the unit will light.
- The recording sound might distort when the PEAK indicator lights.
- If the entire level meter becomes red, the analog circuit is overloading.
- After tapping the GAIN, the wheel can be turned to adjust it precisely.

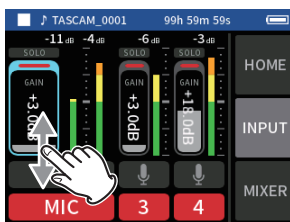

### Using the mixer

1. Tap MIXER at the right of the screen to open the MIXER screen.

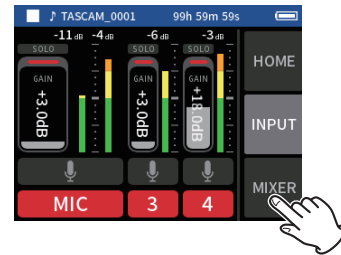

2. Slide the faders of each track to adjust the balance of levels sent to the MASTER.

#### Faders

Use these to adjust the output levels of each track.

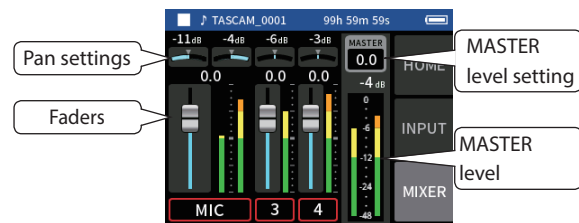

#### Pan settings

Use these to adjust the left-right volume balance.

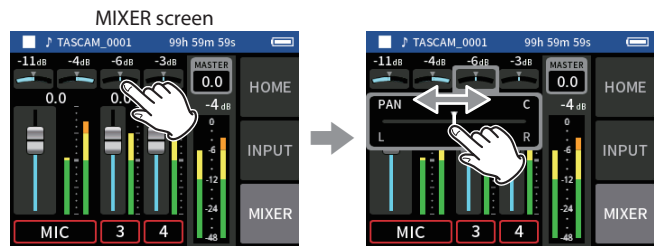

Tap a pan setting.

Slide the slider left and right to adjust the balance.

#### MASTER level setting

Use this to adjust the level of the mix of all tracks. After adjusting the balance of the individual track levels, use this when you want to adjust the overall level.

Change the setting below the fader to MONO if you want to make the mix of all the tracks mono.

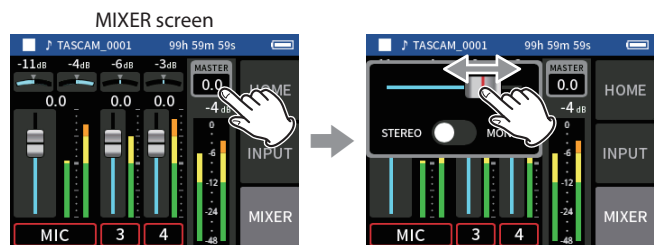

Tap the MASTER level setting.

Slide the fader left and right to adjust the level.

#### NOTE

The mix balance settings are saved when the current project is changed and when the unit is turned off.

The master file stereo/mono setting, however, is not retained by this unit. Always make this setting when recording.

## 6-5 Recording with the MUSIC app

This recording app is good for easily capturing instrumental and vocal performances.

### Screen overview

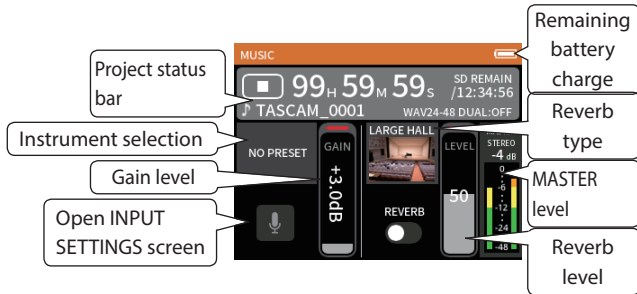

### Shortcut Menu

Press the MENU button on the bottom left of the unit to show the following menu.

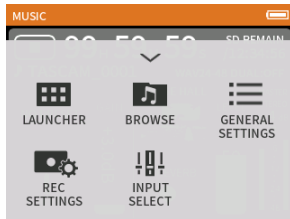

- LAUNCHER**  
App switching and unit settings (page 10)
- BROWSE**  
File operations (page 44)
- GENERAL SETTINGS**  
Additional settings (page 57)
- REC SETTINGS**  
Recording settings and operations (page 36)
- INPUT SELECT**  
Track number and input jack assignments (page 22)

### Selecting the type of instrument to record

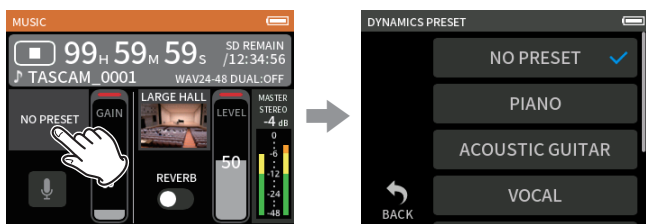

Tap the instrument selection.

Tap the desired instrument.

#### NO PRESET

This unaffected setting does not apply any dynamics preset to the sound.

#### PIANO

Designed for piano

#### ACOUSTIC GUITAR

Designed for acoustic guitar

#### VOCAL

Designed for singing

#### WIND INST.

Designed for wind instruments

#### STRINGED INST.

Designed for string instruments

#### BAND

Designed for band performances

- If none of the options match the desired instrument, select NO PRESET.

### Setting the input level



While watching the level meter, adjust the GAIN so that the level averages around -12 dB and the PEAK indicator does not light.

#### NOTE

- If the input level exceeds -2 dB, the PEAK indicator on the unit will light.
- The recording sound might distort when the PEAK indicator lights.
- If the entire level meter becomes red, the analog circuit is overloading.
- Tap INPUT SETTINGS to adjust settings other than the input level.
- After tapping the GAIN, the wheel can be turned to adjust it precisely.

See “Making input settings for each input” on page 22 for details about input settings.

### Adding reverb to the input (REVERB)

1. Tap the REVERB setting to turn it on.
2. Tap the REVERB TYPE to change the selection.
3. Slide the REVERB LEVEL fader to adjust its level.

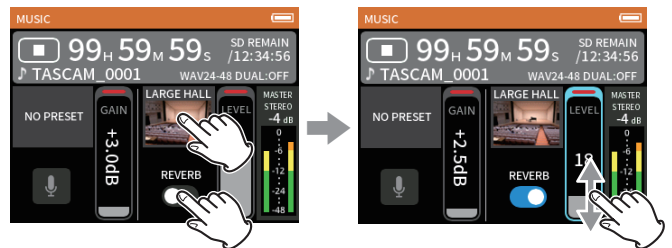

#### NOTE

After tapping the REVERB, the wheel can be turned to adjust it precisely.

For details, see “Adding reverb to inputs (REVERB)” on page 24.

## 6 - Recording apps

### 6-6 Recording with the VOICE app

This recording app is good for recording audio for interviews and video blogs.

#### Screen overview

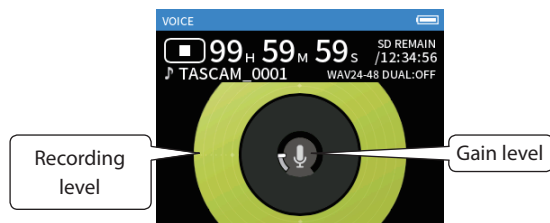

#### Shortcut Menu

Press the MENU button on the bottom left of the unit to show the following menu.

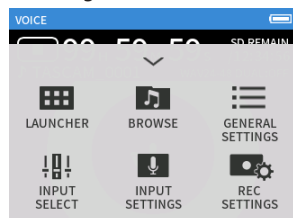

#### LAUNCHER

App switching and unit settings (page 10)

#### BROWSE

File operations (page 44)

#### GENERAL SETTINGS

Additional settings (page 57)

#### INPUT SELECT

Track number and input jack assignments (page 22)

#### INPUT SETTINGS

Input settings (page 22)

#### REC SETTINGS

Recording settings and operations (page 36)

#### Setting the inputs

For details, see "Making input settings for each input" on page 22.

#### Setting the input level

1. Tap the ring in the center of the screen.
2. Speak toward the mic and adjust the GAIN so that the recording level display does not become red.

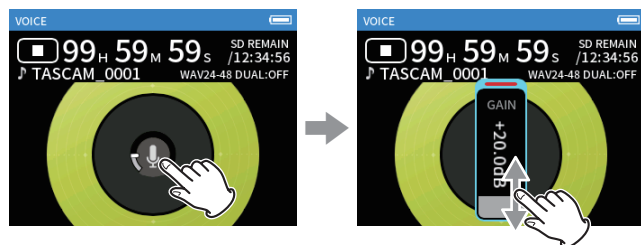

#### NOTE

- If the input level exceeds -2 dB, the PEAK indicator on the unit will light.
- The recording sound might distort when the PEAK indicator lights.
- If the entire level meter becomes red, the analog circuit is overloading.
- After tapping the GAIN, the wheel can be turned to adjust it precisely.



## 6-7 Recording with the FIELD app

This app is good for recording outdoors.

### Screen overview

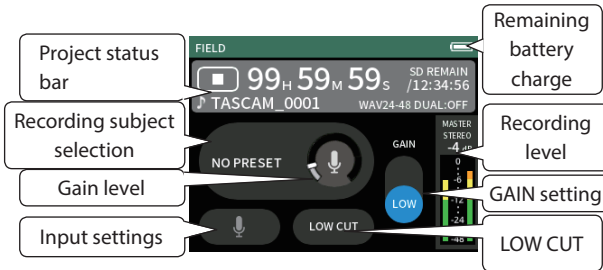

### Shortcut Menu

Press the MENU button on the bottom left of the unit to show the following menu.

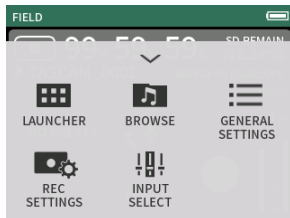

- LAUNCHER**  
App switching and unit settings (page 10)
- BROWSE**  
File operations (page 44)
- GENERAL SETTINGS**  
Additional settings (page 57)
- REC SETTINGS**  
Recording settings and operations (page 36)
- INPUT SELECT**  
Track number and input jack assignments (page 22)

### Setting the inputs

For details, see “Making input settings for each input” on page 22.

### Selecting the recording subject

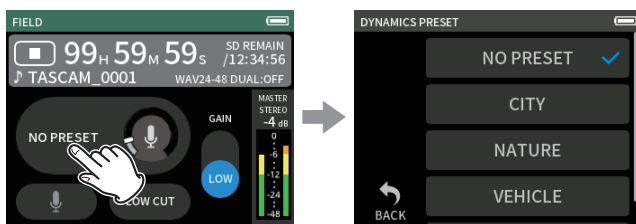

Tap the center of the screen.

Tap the recording subject.

#### NO PRESET

Use mic preamps as is (no processing)

#### CITY

Crowds and other urban sounds

#### NATURE

Rustling leaves, murmuring streams and other natural sounds

#### VEHICLE

Trains, motorsports, etc.

#### BIRD

Wild bird calls and similar sounds

- If none of the options match the desired subject, select NO PRESET.

### Setting the input level

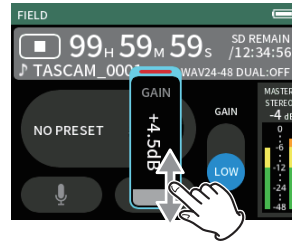

While pointing the mic at the recording subject and watching the level meter, adjust the GAIN so that the level averages around  $-12$  dB and the PEAK indicator does not light.

#### NOTE

- If the input level exceeds  $-2$  dB, the PEAK indicator on the unit will light.
- The recording sound might distort when the PEAK indicator lights.
- If the entire level meter becomes red, the analog circuit is overloading.
- After tapping the GAIN, the wheel can be turned to adjust it precisely.

Tap INPUT SETTINGS to adjust settings other than the input level. See “Making input settings for each input” on page 22 for details about settings.

### Changing the gain (GAIN)

Adjust the input gain using the LOW setting first. If the gain is insufficient, switch to HIGH and adjust the gain.

### Setting the filter (LOW CUT)

The low-cut filter can reduce bothersome noise, such as from wind, air-conditioners and projectors.

Set the cutoff frequency of the low-cut filter to match the noise.

## 6 - Recording apps

### 6-8 Recording with the PODCAST app

This app is good for recording podcasts with up to 2 people.

#### Screen overview

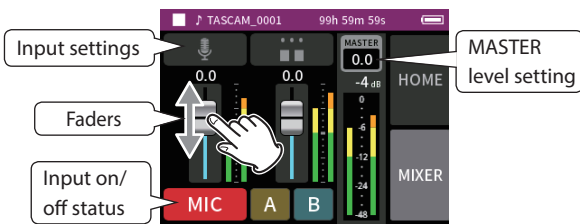
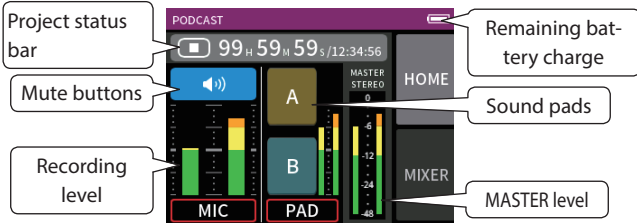

#### Shortcut Menu

Press the MENU button on the bottom left of the unit to show the following menu.

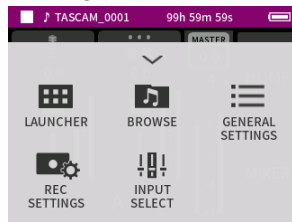

#### LAUNCHER

App switching and unit settings (page 10)

#### BROWSE

File operations (page 44)

#### GENERAL SETTINGS

Additional settings (page 57)

#### REC SETTINGS

Recording settings and operations (page 36)

#### INPUT SELECT

Track number and input jack assignments (page 22)

#### Using the wheel

After tapping a GAIN, fader or pan control or the MASTER level, the wheel can be turned left and right to adjust the setting precisely.

This is convenient for precise adjustments after making rough value changes by sliding.

#### Setting input levels

1. Open the MIXER screen.
2. Tap the input settings icon.
3. While inputting the voice and watching the level meters, adjust the GAIN so that they average around  $-12$  dB and the PEAK indicators do not light.

#### NOTE

- If the input level exceeds  $-2$  dB, the PEAK indicator on the unit will light.
- The recording sound might distort when the PEAK indicator lights.
- If the entire level meter becomes red, the analog circuit is overloading.

MIXER screen

INPUT screen

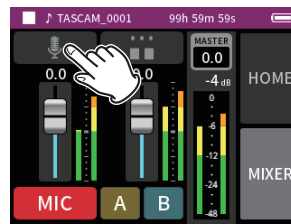

Tap the input settings icon.

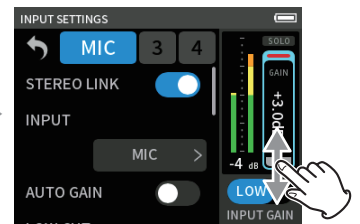

Slide the GAIN fader to adjust the input level.

#### Using the mixer

Slide the faders to adjust the mix balance.

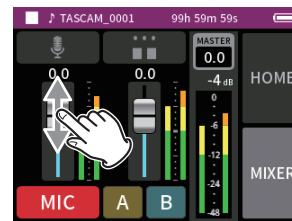

#### MASTER level setting

Use this to adjust the level of the mix of all tracks.

After adjusting the balance of the individual track levels, use this when you want to adjust the overall level.

Change the setting below the slider to MONO if you want to make the mix of all the tracks mono.

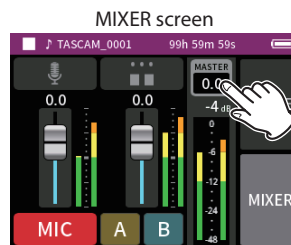

Tap the MASTER level setting.

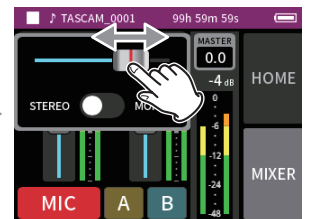

Slide the fader left and right to adjust the level.

#### Making sound pad settings

Sounds can be assigned to the sound pads, and how they play when the buttons are pushed can be set.

#### Selecting the button to set

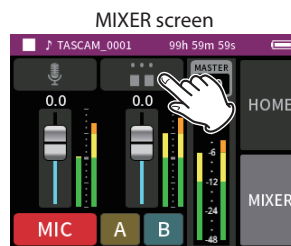

Tap the pad settings on the right side.

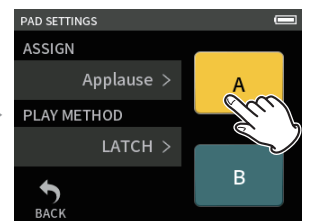

Tap the button of the sound pad to set.

## Setting the playback sound

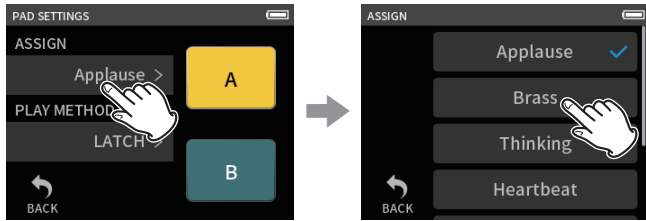

Tap ASSIGN.

Tap the desired setting.

### Applause

This plays sounds of clapping and cheering. This is assigned to yellow pads by default.

### Brass

This plays a horn crescendo. This is assigned to green pads by default.

### Thinking

This plays a short acoustic bass phrase.

### Heartbeat

This plays the sound of a heart beating.

### Ding dong

This plays a door chime twice.

### Wrong answer

This plays a buzzer twice.

### SD CARD

microSD cards that have been formatted by this unit have a SOUNDPAD folder for pad sound sources. ("File and project structure overview" on page 43)

Sound files saved in this folder can be assigned to pads.

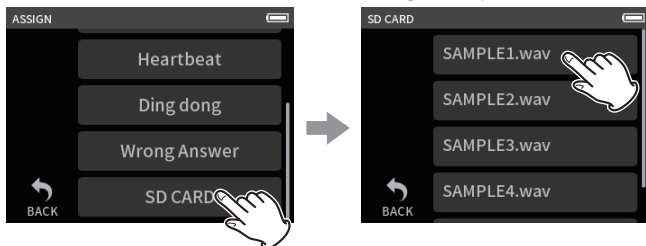

Tap SD CARD.

Tap the desired file.

### NOTE

- Only sounds that are 48 kHz/16-bit WAV format can be assigned to sound pads.
- If SD CARD sound sources have been assigned to sound pads, removing and inserting microSD cards or turning the unit off will reset these to the default settings of Applause and Brass.

## Setting the playback method

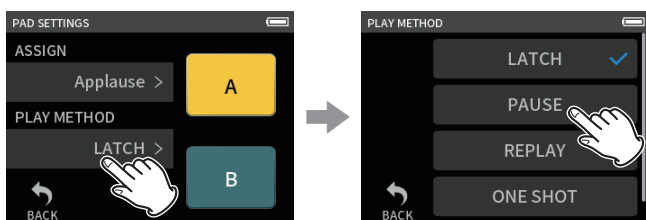

Tap PLAY METHOD.

Tap the desired setting.

### LATCH (default)

Press the pad to start playback from the beginning. Press that pad again to stop playback. Press that pad once again to restart playback from the beginning.

### PAUSE

Press the pad to start playback from the beginning.

Press it again to pause and once more to resume playback.

### REPLAY

Press the pad to start playback from the beginning each time.

### ONE SHOT

Press the pad to play from the beginning.

Pressing the pad again during playback will not stop playback.

Press the pad continuously to force playback to stop.

### REPEAT

Press the pad to start repeat playback from the beginning.

Press the pad again to stop playback.

## Playing effect sounds during recording

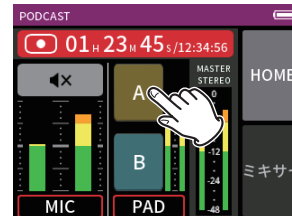

Tap a sound pad to play the sound according to the set playback method.

As it plays, the sound will be recorded to the master and pad track recording files.

### NOTE

Sound pads cannot be played if an SD card is not loaded in the unit.

## Muting mics

Press the mute buttons to mute and unmute channels.

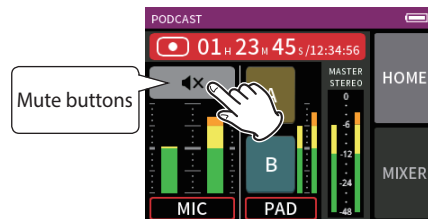

## Starting playback

### NOTE

- If the file was recorded when the current project was using a two-channel recording app or the MANUAL app, the master file will be played.
- The podcast app can only play files that are 48 kHz sampling frequency.

# 7 - Recording settings

## 7-1 Monitoring individual inputs (solo monitoring)

In the MANUAL app, tap the SOLO icon of a track on the INPUT screen to monitor it by itself.

MANUAL app INPUT screen

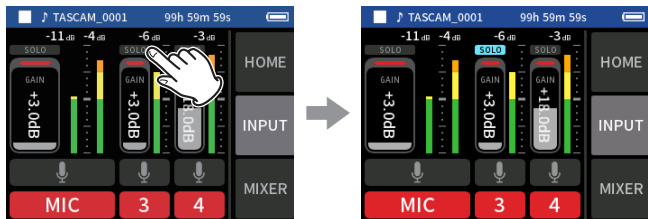

On the INPUT screen, tap the SOLO icon of a track to monitor it alone.

The background of the SOLO icon will become blue and only the sound of that track will be output for monitoring.

- Tap the SOLO icon for the selected track again to output the MASTER signal for monitoring.

When a SOLO button is tapped on the INPUT screen of the MANUAL or PODCAST app, the input channel shown will be enabled for solo monitoring (PFL).

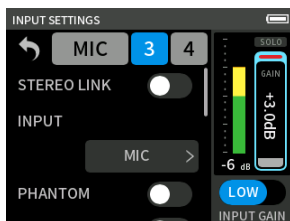

### NOTE

- If inputs are stereo linked, they will be monitored as a stereo source.
- Solo monitoring on the INPUT SETTINGS screen is AFL.

## 7-2 Changing the recording file format

Set this with the GENERAL SETTINGS screen > REC SETTINGS page > FILE FORMAT item.

### FILE FORMAT

Select the file format.

### CAUTION

The following restrictions apply to MP3 file formats.

- Only sampling frequencies of 44.1 and 48 kHz can be selected
- Only the master track will be recorded (track files will not be recorded)

### SAMPLE

Select the sampling frequency.

### BIT DEPTH/BIT RATE

Select the bit depth/rate.

### 32-bit float recording

This unit supports 32-bit float recording. Files recorded using 32-bit float have the following advantages when being edited afterward.

- The levels of quiet sounds can be raised without changing their original sound qualities.
- Sounds that seem clipped can be restored to unclipped sounds by lowering their volumes.

### CAUTION

Analog clipping will not be changed when volume is lowered.

### CAUTION

Only 48 kHz/24-bit can be selected as the recording format in the PODCAST app.

## 7-3 Recording in mono

Change the MASTER level setting on the MIXER screen.

- This setting is only possible when using the MANUAL and PODCAST apps.

MANUAL app MIXER screen

example

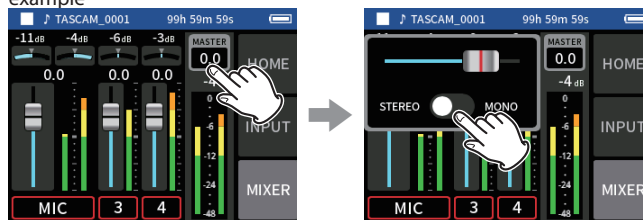

Tap the MASTER level setting.

Tap the STEREO/MONO switch to change the setting.

## 7-4 Pausing during recording (REC PAUSE)

See "Recording pause function" on page 26.

## 7-5 Starting recording automatically (AUTO REC)

Set this with the GENERAL SETTINGS screen > REC SETTINGS page > AUTO REC item.

This function can start recording automatically.

Recording starts automatically when the recording level exceeds a set level. In addition, the unit can be set to pause the current file or start a new file when the recording level goes below a set level.

### AUTO REC

Recording will occur according to the following settings when this is on.

#### START LEVEL

This sets the recording level that starts recording.

When OFF is selected, press the REC [●] button to start recording.

#### END LEVEL

This sets the recording level that stops recording.

When OFF is selected, press the HOME [■] button to stop recording.

#### END DELAY

This sets the time until recording stops after the input goes below the END LEVEL.

If the recording level goes above the END LEVEL before this time elapses, recording will continue.

## END MODE

This sets what happens if the START LEVEL is exceeded again after automatic recording has been started and the recording level has gone below the END LEVEL.

- SAME FILE: Recording continues in the same file
- NEW FILE: Recording starts in a new file

## 7-6 Recording with two settings at the same time (DUAL REC)

Set this with the GENERAL SETTINGS screen > REC SETTINGS page > DUAL REC item.

This enables recording with different formats.

### MP3

### FLOAT

In addition to the ordinary recording, recording with the selected format will also occur.

### NOTE

- MP3 dual format recording cannot be used when the sampling frequency is 96 kHz.
- FLOAT dual format recording cannot be used when the MANUAL app is at 96 kHz.
- When on, the low-cut filter, noise gate, limiter, equalizer and phase inversion will affect both files.

## 7-7 Capturing a few seconds before starting recording (PRE REC)

Set this with the GENERAL SETTINGS screen > REC SETTINGS page > PRE REC item.

When the prerecording function is on and the unit is in recording standby, it can record up to two seconds of signal input before recording is started.

### NOTE

When PRE REC is set to ON, REC PAUSE will also be set to ON.

## 7-8 Adjusting input levels automatically (AUTO GAIN)

Set this with the AUTO GAIN item on the INPUT screen of each app. This will automatically raise and lower the input level in response to the input signal volume. This is ideal for recording meetings and other situations when volume increases and decreases are not a problem.

## 7-9 Recording file naming

See "File name overview" on page 41.

## 7-10 Designating the folder use for recordings

See "File operations" on page 41.

## 7-11 Changing files while continuing to record (file incrementation function)

A file with a new number can be created automatically or manually.

### NOTE

- The number at the end of the file name will increment every time a new file is created.
- If the name of a newly created file would be the same as that of an existing file, the number will be incremented until the new file has a unique name.
- A new file cannot be created if the total number of files and folders would exceed 5000.

### Automatic

Set this with the GENERAL SETTINGS screen > REC SETTINGS page > TIME FILE INCREMENT item.

When the set time elapses during recording, recording in the current file will stop automatically and continue in a new file.

### Manual

Press the ► / || button on the unit while recording to start a new file manually.

## 7-12 Overdubbing and punching in/out (MANUAL app only)

Overdubbing allows additional recording to a separate track while listening to playback tracks, and punching in and out enables overwriting parts of already recorded tracks in a project.

### Overdubbing

1. Launch the MANUAL app, and select the project to use for overdubbing as the current project.  
See "SELECT" on page 45 for procedures to select the current project.
2. Press the MENU button and select "OVERDUB PUNCH I/O" to activate overdubbing and punch in/out mode.

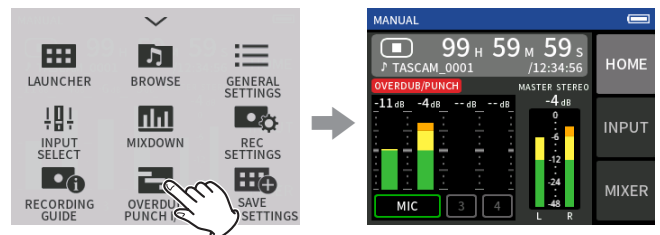

3. Open the INPUT screen, and ready the tracks to be recorded (red).



4. Press the REC [●] button to start recording from the current position.

## 7 - Recording settings

- During recording, sound input on both the tracks being overdubbed (red) and the playback tracks (green) can be monitored.
5. At the overdubbing end point, press the HOME [■] button to stop recording.  
This stops the unit.
  6. Press the MENU button, and select “MODE EXIT” to deactivate overdubbing and punch in/out mode.

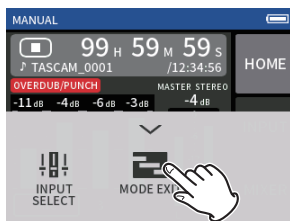

### NOTE

- Since this adds a track, the audio of the master file will also be updated to reflect the change.
- “EXT IN” and “USB” cannot be assigned to recording tracks as new inputs.

### Punching in and out

1. Launch the MANUAL app, and select the current project, which will be used for punching in/out.  
See “SELECT” on page 45 for procedures to select the current project.
2. Press the MENU button and select “OVERDUB PUNCH I/O” to activate overdubbing and punch in/out mode.

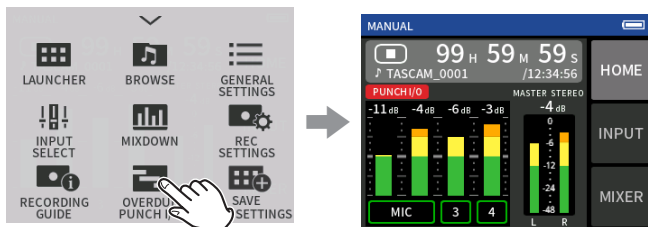

3. Play the project and determine the timing for overwriting in advance. Select a point where the overwritten audio can be combined well with the original track audio.

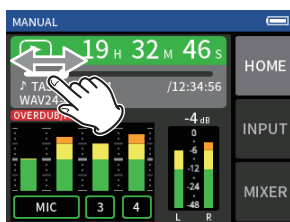

4. Open the INPUT screen, and ready the track to be overwritten for recording (red).

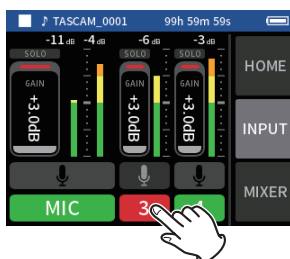

5. Press the REC [●] button at the moment to start overwriting. The overwriting of the track enabled for recording (red) will start. (Punch in.)  
During recording, sound input on both the track being overwritten (red) and the playback tracks (green) can be monitored.
6. At the end of the section to be overwritten, press the HOME [■] button to stop recording. (Punch out.)  
This stops the unit.
7. Press the MENU button and select “MODE EXIT” to deactivate overdubbing and punch in/out mode.

### NOTE

- Since punching in/out overwrites part of a track, the audio of the master file will also be updated to reflect the change.
- When punching in/out, “MIC/EXT IN” and “USB” cannot be assigned to recording tracks as new inputs.

### Undoing overdubbing and punching in/out (UNDO)

The most recent overdubbing and punching in/out recording can be undone.

1. When in overdubbing and punch in/out mode, press the MENU button at the bottom left of the unit and select “UNDO”.

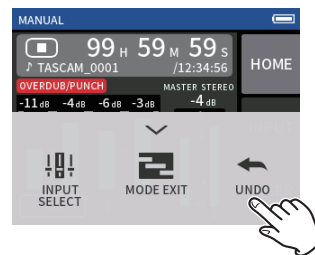

A message confirming execution of the UNDO operation will pop up.

2. Select YES.  
The recording will be returned to the state before the last overdubbing and punching in/out operation was conducted.

### Canceling UNDO operations (REDO)

1. After conducting an UNDO operation, press the MENU button at the bottom left of the unit, and select “REDO”.

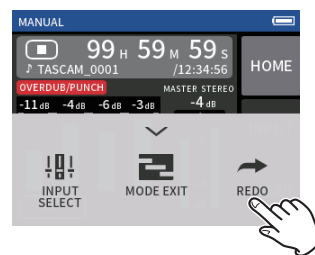

A message confirming execution of the REDO operation will pop up.

2. Select YES.  
The unit will be restored to the state after the last overdubbing and punching in/out recording was conducted.

### NOTE

- UNDO and REDO can only be used on the most recent overdubbing and punching in/out recording.
- If overdubbing and punching in/out mode is ended or the unit is turned off, the data used for UNDO and REDO operations will be lost, making them no longer possible.
- If the current file is an mp3 file, overdubbing and punch in/out mode cannot be activated.

### 7 - 13 Recording times (in hours: minutes)

File format (recording setting)		Card capacity	
		32 GB (microSDHC)	128 GB (microSDXC)
320 kbps MP3 (stereo)	44.1 kHz	222:13	888:53
16-bit WAV (stereo)		50:23	201:33
24-bit WAV (stereo)	96 kHz	15:25	61:43
32-bit float WAV (stereo)	96 kHz	11:34	46:16

- The recording times shown above are estimates. They might differ depending on the microSD card in use.
- The recording times shown above are not continuous recording times, but rather they are the total possible recording times for the microSD card.
- If recorded in mono, maximum recording times will be about double those above.
- If using dual recording, maximum recording times will be shorter than those above.

#### NOTE

If the size of a file exceeds 4 GB during recording, a new file will be created and recording will continue in that file (file incrementation). See "File name overview" on page 41 for information about file names.

# 8- Playing files

## 8-1 Opening the playback screen

When a recording app screen is open, press the ►/|| button to play the last recorded file.

Recording app screen open

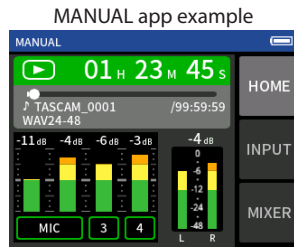

Press the ►/|| button.

The last recorded file will play back.

- In the MANUAL and PODCAST apps, the track files will be played and the sound will be output from the mixer. For this reason, track output levels can be changed by adjusting the mixer settings to affect the output sound. ("Adjusting the mix balance of the tracks" on page 40)
- In the ASMR, MUSIC, VOICE and FIELD apps, master files will be played back.
- When using the PLAY menu on the BROWSE screen, master files will be played back regardless of the app used for recording.

### Screen overview

#### Project status bar

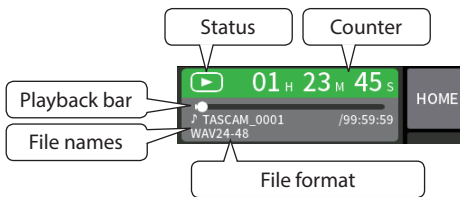

### Playing and pausing

When stopped or paused, press the ►/|| button to start playback.



### Stopping playback

During playback, press the HOME [■] button to stop playback.



### Changing the playback position

Slide the playback slider to the desired playback position.

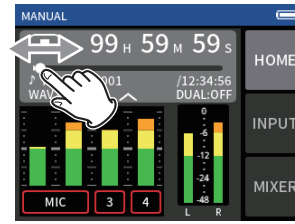

### Selecting files for playback

Use the ◀◀ and ▶▶ buttons to select a file for playback. Pressing the ◀◀ button during playback will return to the beginning of the file. Pressing the ◀◀ button at the beginning of a file will skip to the beginning of the previous file. If you press the ▶▶ button when located at the beginning or middle of a file, the playback position will skip to the beginning of the next file.

### Searching backward and forward

Use the ◀◀ and ▶▶ buttons to search backward and forward.

### Adjusting the mix balance of the tracks

This operation is possible when using the MANUAL and PODCAST apps. Open the MIXER screen, and slide the faders as desired to adjust the mix balance.

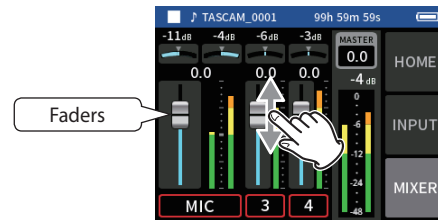

Each project will play back with the mix balance used when it was recorded. Changes to a mix balance during playback will not be saved. Use the mixdown function to change the mix balance of a project that has already been recorded. ("Mixdown function" on page 52)

#### CAUTION

The mix balance will not be saved properly if the microSD card is removed from the unit during operation.



Recording data is saved in the SOUND folder on the microSD card. The two types of recording data are track files and master files. The types of files saved depend on the recording app. For details, see "Recording app output files" on page 12. This unit can record and play wav (including BWF) and mp3 files.

---

## 9-1 File name overview

---

Files recorded by this unit are named as described below.

Project name    Track number  
└──────────┬──┘  
TASCAM\_0001\_1.wav  
└──┬──┘ └──┬──┘  
  File number

Characters set by user    File number

### Characters set by user

When TYPE is set to DATE

YYMMDD (YY: year, MM: month, DD: date)

Two digits each are used for the year (last two), month and date.

When TYPE is set to WORD

A string of 6–9 characters can be specified as wanted.

The default value is "TASCAM".

The usable characters are as follows.

Uppercase and lowercase alphabet letters numerals 0–9,  
and the following symbols:

! # \$ % & ' ( ) + , - . : ; = @ [ ] ^ \_ ` { } ~ (space)

### File numbers

This shows the order recorded.

The default value is "0001".

For dual files

DUAL FORMAT

FLOAT: File number+F

MP3: File number+M

For mixdown files

File number + MIX + number of times

For divided files

File numbers + \_A and \_B

For files divided by marks

File number + number of times (\_01, \_02, \_03...)

### Track number

This shows which track was recorded. This is only added to track files.

When stereo-linking off

Track number 1, 2, 3, 4, 5, 6

When stereo-linking on

Linked track numbers 1–2, 3–4, 5–6

For master files

2-channel apps: None

MANUAL/PODCAST app: \_MIX

### Project name

This is the characters set by the user and the file number connected by an underscore (\_).

Since the file number is increased each time a file is recorded, the project also changes with each recording. See "Project overview" on page 44 for details.

## 9 - File operations

### File name examples

The tables below show how, starting with the following conditions, files are named according to the settings.

Characters set by user: TYPE set to WORD (TASCAM)

File number: 0001

With 2-channel recording apps (ASMR, MUSIC, VOICE, FIELD)

Settings	File names	File types
1st recording	TASCAM_0001.WAV	Master file
2nd recording	TASCAM_0002.WAV	Master file

With MANUAL and PODCAST apps

Settings	File names	File types
Tracks 1–4 set to mono	TASCAM_0001_1.WAV	Track file
	TASCAM_0001_2.WAV	Track file
	TASCAM_0001_3.WAV	Track file
	TASCAM_0001_4.WAV	Track file
	TASCAM_0001_MIX.WAV (master files are always created)	Master file
Tracks 1–2 and 3–4 stereo-linked	TASCAM_0001_1-2.WAV	Track file
	TASCAM_0001_3-4.WAV	Track file
	TASCAM_0001_MIX.WAV (master files are always created)	Master file
Tracks 1–2 set to mono Tracks 3–4 stereo-linked	TASCAM_0001_1.WAV	Track file
	TASCAM_0001_2.WAV	Track file
	TASCAM_0001_3-4.WAV	Track file
	TASCAM_0001_MIX.WAV (master files are always created)	Master file
Dual files (handled as separate projects)	DUAL FORMAT (FLOAT) TASCAM_0001_1.WAV TASCAM_0001F_1.WAV	
	DUAL FORMAT (MP3) TASCAM_0001_1.WAV TASCAM_0001M_1.MP3	
File division	TASCAM_0003_1-2.WAV ↓ TASCAM_0003_A_1-2.WAV (treated as separate project)	Manually-divided file
	TASCAM_0003_B_1-2.WAV (treated as separate project)	Manually-divided file
File division from marks	TASCAM_0003_1-2.WAV ↓ TASCAM_0003_01_1-2.WAV (treated as separate project)	Mark-divided file
	TASCAM_0003_02_1-2.WAV (treated as separate project)	Mark-divided file

With MANUAL app

Settings	File names	File types
Mixdown files	TASCAM_0002_1.WAV	Track file
	TASCAM_0002_2.WAV	Track file
	TASCAM_0002_3.WAV	Track file
	TASCAM_0002_4.WAV	Track file
	When the 4 files above are mixed down ↓ TASCAM_0002MIX.WAV (created as separate project)	Mixdown file
	TASCAM_0002MIX2.WAV (created as separate project distinct from the first)	Mixdown file

## Changing how files are named

Set this with the GENERAL SETTINGS screen > SYSTEM page > FILE NAME item.

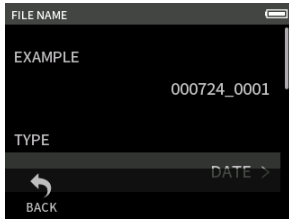

### EXAMPLE

The result of the current settings can be checked here.

### TYPE

Set the characters used at the beginning of the file name.

DATE (default)

The DATE is added to the file name.

YYMMDD (YY: year, MM: month, DD: date)

Two digits each are used for the year (last two), month and date.

WORD

The 6–9 characters set with WORD EDIT are added to the file name.

The default value is "TASCAM".

### WORD EDIT

Use this to input the file name.

For details about character input, see "App overview" on page 10.

### NOTE

If DATE is selected, the file name will be created using the date and time of the unit's internal clock. Set the clock in advance to enable recording with the correct date and time.

## Resetting the file number

Set this with the GENERAL SETTINGS screen > SYSTEM page > FILE NAME item.

### FILE No. RESET setting

Off (default)

The file number will not be reset.

On

The file number will automatically be reset when formatting, creating a new folder, or deleting all the files in a folder.

### Exec

This will reset the file number the next time a file is created.

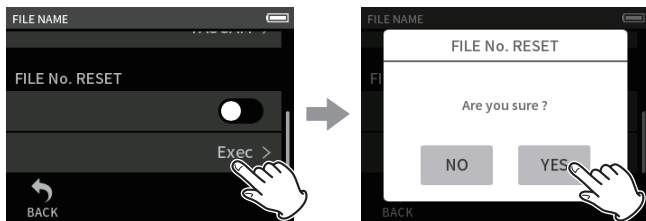

Tap Exec.

Tap YES.

## 9-2 File and project structure overview

### Folders

Formatting microSD cards with this unit will create SOUND, UTILITY and SOUNDPAD folders.

Recording data is saved in the SOUND folder.

Folders can be created inside the SOUND folder.

Create them as necessary. ("Creating folders (NEW)" on page 44)

### Recording data

Recorded data is saved in the current folder.

After a microSD card is formatted, the SOUND folder becomes the current folder.

To change the current folder, select the folder on the BROWSE screen, and tap OPEN. ("Setting where recording files are saved" on page 47)

## 9-3 Folder hierarchy example

This illustration is an example of the folder hierarchy on a microSD card used with this unit.

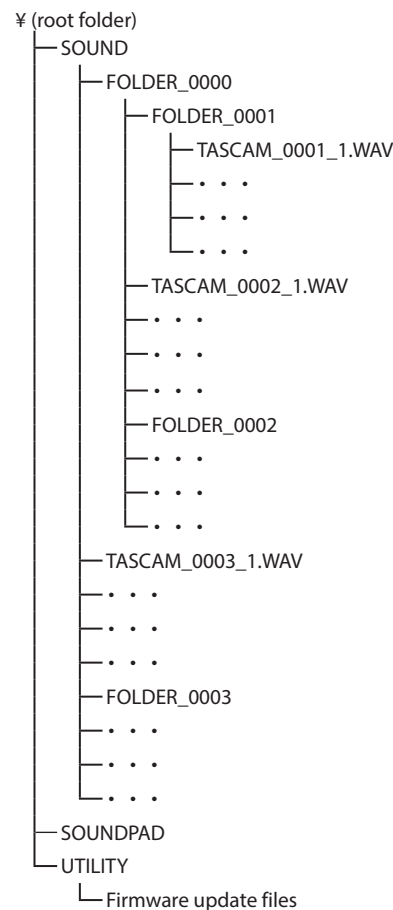

- SOUND, UTILITY and SOUNDPAD folders will be created automatically during formatting.
- Only two levels of subfolders can be created.
- The maximum total number of files and folders is 5000.
- Everything in the SOUND folder and its subfolders is shown on the BROWSE screen.

# 9 - File operations

## 9-4 Project overview

The track and master files created during a single recording are referred to collectively as the project.

Files belong to the same project if the characters set by the user through the file numbers in their names are the same. See "File name overview" on page 41 for details about project names. The way project names are given can be changed in the same manner as for file names. ("Changing how files are named" on page 43)

### Example

Project name	Files in the same project	File types
TASCAM_0001	TASCAM_0001_1.WAV	Track file
	TASCAM_0001_2.WAV	Track file
	TASCAM_0001_3.WAV	Track file
	TASCAM_0001_4.WAV	Track file
	TASCAM_0001_MIX.WAV	Master file
TASCAM_0002	TASCAM_0002.WAV	Master file

- Track files might not be created depending on the recording app. See "Recording app output files" on page 12 for details.
- Individual files not created by this unit and loaded from a computer or other source are each treated as a single project.

## 9-5 Using the BROWSE screen

When an app screen is open, press the MENU button at the bottom left of the unit to open the BROWSE screen.

Alternatively, tap the BROWSE icon on the LAUNCHER screen.

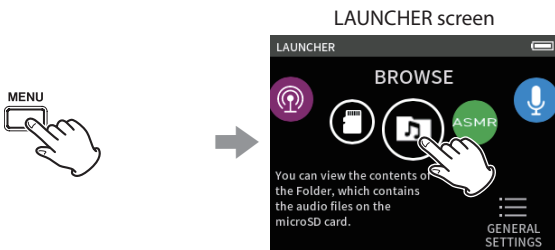

Press the MENU button at the bottom left of the unit, and tap the BROWSE icon.

## 9-6 Folder operations

### Screen overview

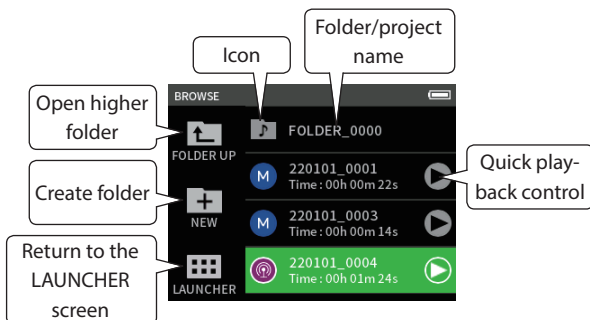



### Icon

The apps used to record files on this unit are shown with icons. Folders are shown with .

### Folder/file name

Tap this to open the folder menu or file menu.

### Quick playback control

Tap  to start playback, and tap  to stop playback.

### Folder menu

#### OPEN

This shows the contents of the folder.

#### RENAME

This opens the RENAME screen where the folder name can be edited.

#### ALL FILES DELETE

This deletes all projects and files inside the folder. Folders, however, will not be deleted.

#### FOLDER DELETE

This deletes the folder and the files and folders inside it.

### Creating folders (NEW)

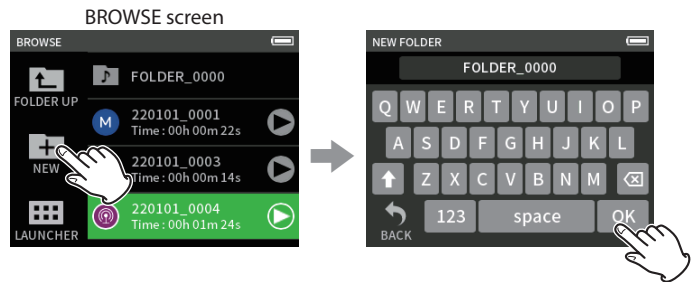

Tap the NEW icon.

Tap OK to create a folder with the name shown.

- If a folder named FOLDER+number already exists, tapping the NEW icon will show FOLDER+(number+1) as the default value. If you want to change this name, delete it once and input it again.
- See "Character input" on page 14 for how to input characters.

### Changing the names of folders (RENAME)

Tap the desired folder on the BROWSE screen, and do the following.

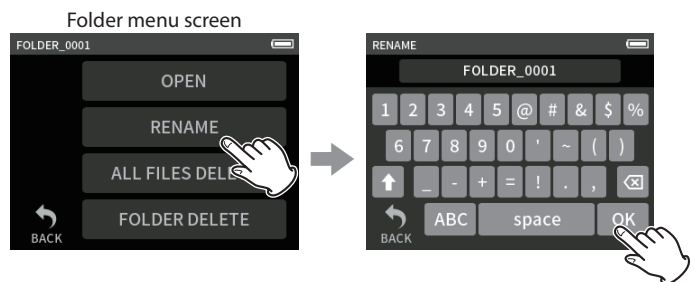

Tap RENAME.

Input the folder name and tap OK.

- See "Character input" on page 14 for how to input characters.
- In folder names, 1–11 characters can be changed.

## Deleting all files in a folder (ALL FILES DELETE)

1. Tap the desired folder on the BROWSE screen.
2. Tap ALL FILES DELETE.

### NOTE

The selected folder will not be deleted.

## Deleting folders (FOLDER DELETE)

1. Tap the desired folder on the BROWSE screen.
2. Tap FOLDER DELETE.

### NOTE

Folders that have files remaining in them cannot be deleted. Delete all the files in the folder before deleting the folder.

## 9-7 File and project operations

### File menu

#### SELECT

This sets the selected file as the current project.

#### PLAY

This plays the master file of the selected project.

#### FILE INFORMATION

This shows information about files in the project.

#### FILE DELETE

This deletes the file.

#### TRACK DELETE

Use this to select and delete track files in the project.

- This is shown when a recorded file is selected in the MANUAL or PODCAST app.

#### CHANGE PROTECT

Use this to activate/deactivate the protection of files in the project.

#### RENAME

Project names can be changed.

- Only projects that have been recorded by this unit can be changed. The number of characters can be changed to between 6 and 9.

#### MARK

This opens a list of the marks.

#### DIVIDE

Use this to divide files.

#### NORMALIZE

Use this to normalize files.

## SELECT

The selected file becomes the current project, and the app used for recording appears on the Home Screen.

Press the ►/|| button to play track files in the current project.

### NOTE

If a file not created by this unit is selected, it will be played using the MANUAL app.

### Current project

The name of the file shown in the project status bar is the current project. Conducting recording or playback will switch the current project.

## Playing master files(PLAY)

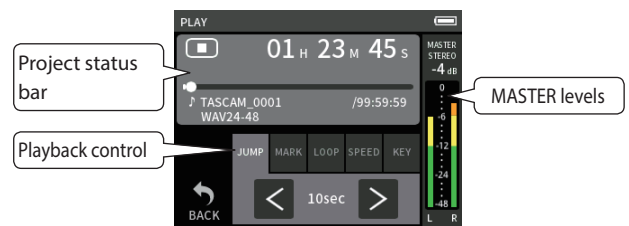

1. Tap the name of the file to play on the BROWSE screen.
2. Tap PLAY. This opens the PLAY screen.
3. Press the ►/|| button on the unit.

### NOTE

- Tapping the quick playback ► button on the BROWSE screen will also start playback.

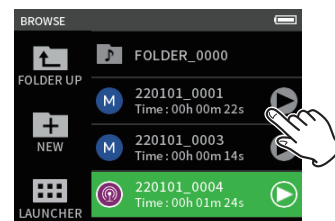

- Starting playback from the BROWSE screen will play the master file. To adjust the mix balance during playback of tracks recorded using the MANUAL or PODCAST app, set the project to be played as the current project (see previous section), open the MIXER screen of that app, and press the ►/|| button on the unit. ("Adjusting the mix balance of the tracks" on page 40)

## Jumping 10 seconds backward/forward

Tap the JUMP playback control, and tap the < and > buttons to jump.

## Jumping to mark locations

1. Tap the MARK playback mode tab.

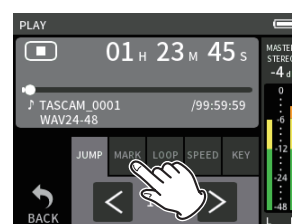

2. Tap < or > to jump.

Tap the flag icon to select which marks to use when skipping between marks.

### ALL

Skip between all marks

### MANUAL

Skip between marks that were added manually

### LEVEL

Skip between LEVEL marks that were added using the automatic mark function

### TIME

Skip between TIME marks that were added using the automatic mark function

### PEAK

Skip between marks added when a PEAK indicator lit.

## 9 - File operations

### BOF

Skip between marks added when microSD card write errors occurred during recording

### NOTE

See "Playing files" on page 40 to view the mark list or delete them all at once.

### Looping playback

Intervals between two points in a single file can be played repeatedly (loop playback).

1. Tap the LOOP playback mode tab.
2. When playing or paused, tap the IN button to set the playback starting point.  
The playback starting point (IN) will be shown on the playback bar.
3. When playing or paused, tap the OUT button to set the playback ending point.  
The playback ending point (OUT) will be shown on the playback bar.  
Playback will start from the playback starting point.

### NOTE

Returning to the Home Screen will clear the playback starting (IN) and ending (OUT) points.

### Ending loop playback

Tap the LOOP RESET button at the bottom of the screen to clear the playback starting and ending points.

### Changing the playback speed (VSA playback)

1. Tap the SPEED playback mode tab.
2. Tap the DOWN and UP buttons to adjust the playback speed as desired.

### Changing the playback pitch (KEY)

1. Tap the KEY playback mode tab.
2. Tap ♭ or # to adjust the pitch.

### NOTE

VSA playback and pitch change functions cannot be used with 96 kHz playback files.

### Viewing file details (FILE INFORMATION)

1. Tap the name of the file to view on the BROWSE screen.
2. Tap FILE INFORMATION.  
Information about the selected file will be shown.

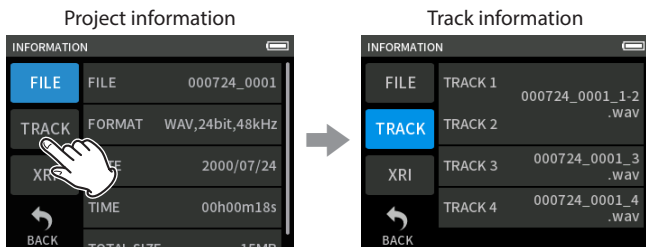

Tap TRACK.

### FILE

This shows the project name, recording format, recording date, playback time and file size.

### TRACK

This shows all the track files in the project. If the project has no track files or was not recorded by this unit, only the master file will be shown.

### Deleting files and projects (FILE DELETE)

1. Tap the name of the project to delete on the BROWSE screen.
2. Tap FILE DELETE.

### NOTE

A protected (read only) file cannot be deleted.

### Deleting tracks in projects (TRACK DELETE)

1. Tap the name of the project to delete on the BROWSE screen.
2. Tap TRACK DELETE.

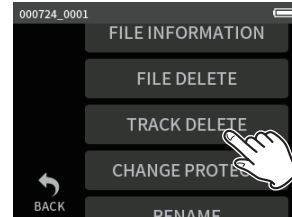

3. Tap all the track files to be deleted.

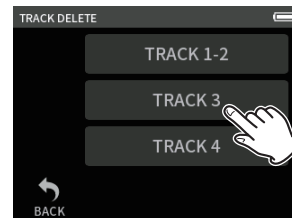

### NOTE

- Tracks can only be deleted in projects recorded using the MANUAL and PODCAST apps.
- VSA playback and pitch change functions cannot be used with 96 kHz playback files.
- Deletion of the contents of tracks does not affect master files.

### Enabling and disabling protection (CHANGE PROTECT)

Project protection can be enabled and disabled.

1. Tap the name of the file to change protection for on the BROWSE screen.
2. Tap CHANGE PROTECT.  
This enables or disables protection.

### NOTE

Lock marks (🔒) will be shown to the bottom right of icons for files that are protected

### Changing names (RENAME)

Project names can be changed.

1. Tap the name of the project to change on the BROWSE screen.
  2. Tap RENAME.
  3. Input the new project name and tap OK.
- See "Character input" on page 14 for how to input characters.

## Viewing the mark list (MARK)

1. Tap the name of the file to view on the BROWSE screen.
2. Tap MARK.  
A list of marks will be shown

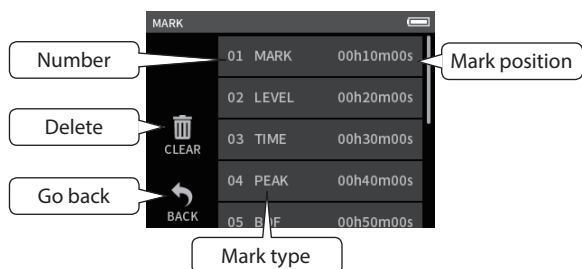

See “Mark functions” on page 48 for information about mark types.

## Deleting marks

Tap the trashcan icon to delete all marks.

### NOTE

See “Deleting marks” on page 48 for details about the deleting individual marks.

## Dividing files (DIVIDE)

1. Tap the name of the project to divide on the BROWSE screen.
2. Tap DIVIDE.
3. Move the pointer on the playback bar to the division point and pause playback.  
Move the playback pointer by, for example, playing the file, searching forward/backward, and sliding it along the playback bar.

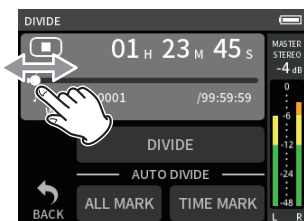

4. Tap DIVIDE.

### NOTE

- If the project has track files, the track files will also be divided.
- Tap ALL MARK to divide the file at every mark position.
- Tap TIME MARK to divide the file at every mark added by the automatic mark function TIME option.
- Only files in projects that have been recorded by this unit can be divided.
- MP3 files cannot be divided.
- The DIVIDE function does not affect PEAK marks.

## Normalizing recordings (NORMALIZE)

This function finds the loudest volume in a recorded file and raises the volume of all the recording data so the loudest volume is at the maximum level.

1. Tap the name of the file to normalize on the BROWSE screen.
2. Tap NORMALIZE.

### NOTE

- Since the data of the selected project will be overwritten, it cannot be restored.
- Only files recorded by this unit can be normalized.
- This function is applied to master files. It does not affect track files.

## 9-8 Setting where recording files are saved

Recording data is saved in the current folder.

Follow the procedures below to select a folder and make it the current folder.

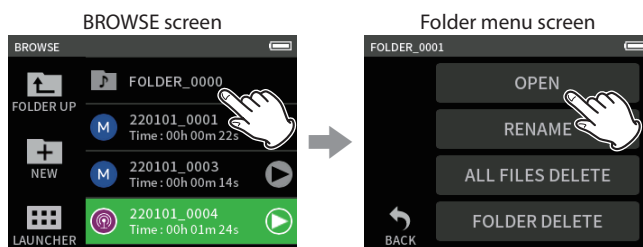

Tap the folder to make current.

Tap OPEN.

### NOTE

When the current file is selected, its folder becomes the current folder.

# 10 - Mark functions

---

## 10-1 Mark types

---

The types of marks and conditions when they are added are as follows.

### Manual

Marks added manually

### LEVEL

Marks added when input signal exceeds specified level

### TIME

Marks added when set time elapses

### PEAK

Marks added when input signal exceeds peak level

### BOF

Marks added when microSD card write errors occur during recording

---

## 10-2 Adding marks

---

### Adding marks manually

When playing, recording or in recording standby, press the unit MARK button to add a mark at any point.



When a mark is added, a pop-up with mark information appears at the bottom of the display.

---

### Adding marks automatically (AUTO MARK)

Set this with the GENERAL SETTINGS screen > OTHER SETTINGS page > AUTO MARK item.

#### OFF

Marks will not be added automatically.

#### LEVEL

Marks will be added automatically when the input signal exceeds the set level.

#### TIME

Marks will be added automatically when the set time elapses during recording.

---

### Adding marks when peak levels occur (PEAK MARK)

Set this with the GENERAL SETTINGS screen > OTHER SETTINGS page > PEAK MARK item.

When this is on, marks will be added automatically when input signals exceed the peak level during recording. This can be used after recording to find parts where the peak level was exceeded.

---

## 10-3 Deleting marks

---

A mark can be deleted by pressing the MARK button when stopped or paused at its position. When a mark is deleted, a pop-up with information about the deleted mark appears at the bottom of the display.

---

### Deleting all marks

See "Deleting marks" on page 47.

---

## 10-4 Jumping to set marks (mark skipping)

---

See "Jumping to mark locations" on page 45.

### NOTE

Marks in different files cannot be skipped to.

---

## 10-5 Dividing files at every mark

---

See "Dividing files (DIVIDE)" on page 47.

---

## 10-6 Opening mark lists

---

See "Viewing the mark list (MARK)" on page 47.



## 11-1 Setting the output for camera use

Set this with the GENERAL SETTINGS > CAMERA SETTINGS > OUTPUT item. When connecting the LINE OUT jack to a camera, LINE OUT jack output can be attenuated –20 to –30 dB. This enables inputting audio to the camera at a suitable level.

When OUTPUT is set to CAMERA, the output from the LINE OUT jack is attenuated –20 dB.

Slide the LEVEL slider left and right to adjust the attenuation in a range from –20 to –30 dB.

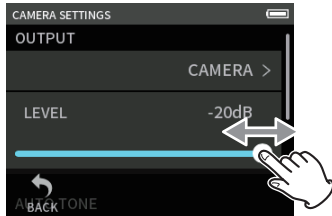

## 11-2 Using the automatic slate tone function (AUTO TONE)

Set this with the GENERAL SETTINGS screen > CAMERA SETTINGS > AUTO TONE item.

The auto tone function can be used to automatically insert a tone signal whenever recording starts and stops.

By connecting the LINE OUT jack on the left side of the unit to the audio input jack of a camera, both units can record the same tone signals to their files. These tones can be used as guides to synchronize files in video editing software.

### Setting the AUTO TONE function

Set where tone signals are inserted.

#### OFF

No tone signals are inserted.

#### HEAD

Tone signals are only inserted at the start of recording.

#### HEAD+TAIL

Tone signals are inserted at both the start and end of recording.

### Adjusting the tone volume

Set the tone volume.

The default value is –12 dB.

# 12 - USB connection

## 12-1 Connecting with computers

See “Connecting computers and smartphones” on page 21.

## 12-2 Connecting with iOS devices

To connect with an iOS device, a Lightning to USB Camera Adapter and a USB cable (Type-A to Type-C) are necessary.

### NOTE

- This unit will not provide power to an iOS device when they are connected.
- Set the power supply to battery power.

## 12-3 Accessing microSD cards from a computer

On the GENERAL SETTINGS screen OTHER SETTINGS page, select the SD CARD READER item.

The unit display will change. The microSD card in the unit can be accessed when it is recognized by the computer.

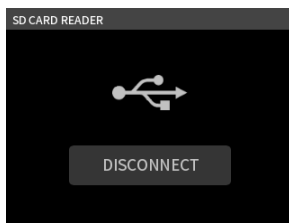

## Exchanging files with computers

Click the “X6” drive on the computer to show the SOUND, SOUND PAD and UTILITY folders.

To transfer files from the computer, drag and drop the desired audio files on the computer to the SOUND folder. To transfer files from the microSD card to the computer, drag and drop the desired audio files from the SOUND folder to any folder on the computer.

### TIP

- The SOUND folder can be managed from the computer.
- Subfolders can be created in the SOUND folder. Only two levels of subfolders can be created. This unit cannot recognize subfolders and audio files on the third level or below.

### NOTE

Follow the procedures specified for the computer to disconnect the unit from it.

## 12-4 Using the ASIO driver

A Portacapture X6 ASIO driver can be used with Windows. Check the page for this product on the TASCAM website for details.

<https://tascam.jp/int/>

### NOTE

With a Mac, the standard OS driver will be used, so there is no need to install any software.

## 12-5 Using as an audio interface

This unit can be used as a USB audio interface by connecting it to a computer using a USB cable.

- Sound played back on this unit cannot be output over USB.

### When a microSD card is loaded

1. Manually set this unit and the computer to use the same sampling frequencies.  
“Changing the recording file format” on page 36 for procedures to change the sampling frequency of this unit.
2. After changing the sampling frequency, starting recording or recording standby will cause audio to be transmitted.

### When a microSD card is not loaded

This unit will operate using the sampling frequency of the computer.

## Portacapture X6 USB audio channel assignments

USB channels	Signals
USB IN 1-2	Stereo mix
USB IN 3-4	Input signals from either inputs 1-2 or MIC/EXT IN according to selection
USB IN 5-6	Inputs 3-4

- The signals sent over USB vary according to the type of recording app being used and the input on/off settings.

### MANUAL, PODCAST

Signals assigned to tracks with input on and a stereo mix are sent over USB.

### ASMR, MUSIC, VOICE, FIELD

Signals assigned to TRACK 1-2 and a stereo mix are sent over USB.

- Settings affect USB audio signals as follows.

Menu item	Function	USB IN 3-6 (inputs 1-4)	USB IN 1-2 (MIX)
INPUT SETTINGS	GAIN (AUTO GAIN)	○	○
	LOW CUT	–	○
	NOISE GATE	–	○
	LIMITER/COMP	–	○
	EQ	–	○
	PHASE INVERT	○	○
MIXER	Faders (tracks 1-4)	–	○
	Fader (MASTER)	–	○
	Pan settings	–	○
	STEREO/MONO	–	○
I/O SETTINGS	MIC TRIM	○	○
	MS DECODE	–	○
	Reverb (tracks 1-4)	–	○
	REVERB (MASTER)	–	○
CAMERA SETTINGS	AUTO TONE	–	○

○ : Affect signals

– : Do not affect signals

## 12-6 Using the unit as a USB mic

By connecting this unit with a computer using a USB cable, you can use it as a USB mic for online communication and streaming, for example. Up to 4 inputs can be used with the MANUAL app.

### NOTE

The automatic power saving function is disabled when in USB audio interface mode.

### Inputting sound to the computer using the unit inputs

1. Use a USB cable to connect the computer and the unit.
2. Set the audio input device to "Portacapture X6" on the computer. Set this unit and the computer to use the same bit depths and sampling frequencies.
3. Launch the recording app to be used. If using the MANUAL or PODCAST app, enable input of the tracks assigned to the input jacks to be used as computer inputs.

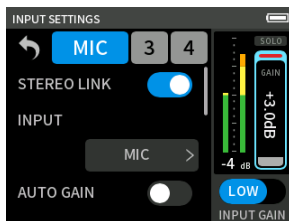

If using the ASMR, MUSIC, VOICE or FIELD app, signals from the input jacks assigned to TRACK 1-2 in the INPUT SELECT settings will automatically be used as the computer inputs. Signals from other input jacks will not be input to the computer.

### Using the computer output as sound input to this unit

1. Use a USB cable to connect the computer and the unit.
2. Set the audio input device to "Portacapture X6" on the computer. Use the same sampling frequency settings for both the unit and the computer.
3. Launch the MANUAL or PODCAST app.
4. Select INPUT SELECT from the Shortcut Menu, and select USB for tracks to assign sound from the computer to them. ("Using the INPUT SELECT function" on page 22)
5. Enable input of tracks that have USB assigned.



### CAUTION

Completing these procedures in addition to the procedures in "Inputting sound to the computer using the unit inputs" above could cause feedback if input monitoring is enabled in the software being used (DAW or calling/streaming app, for example). This might cause sudden loud noises, which could damage the equipment or harm hearing.

When returning the input sound of this unit back to it from a computer, turn input monitoring off in the software and apps on the computer.

### NOTE

Adjust the USB volume from the computer.

# 13 - Other functions and apps

## 13-1 Mixdown function

In the MANUAL app, the volume levels and panning settings of each track in an existing project can be adjusted to create a new mix.

1. Launch the MANUAL app.

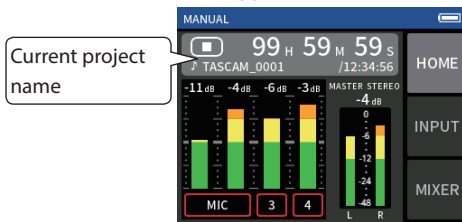

2. Make the project to be mixed down the current project. See "SELECT" on page 45 for procedures to select the current file.
3. While the current project is playing, use faders, panning and other controls on the MIXER screen to adjust the volume and stereo positioning of each track. See "Using the mixer" on page 30 for adjustment procedures.

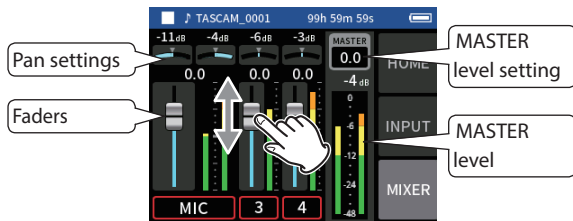

4. Press the MENU (shortcut menu) button at the bottom left of the unit, and tap MIXDOWN to start the mixdown.



5. A master file of the mix will be created in a new project.

### NOTE

- See "File name overview" on page 41 for information about the names of mixdown files.
- Only files recorded by this unit can be mixed down.

## 13-2 Using the mid-side decoding function

In the MANUAL app, mid-side mics can be used for recording, and their recordings played back.

See "Connecting mid-side mics" on page 20 for details about connecting mid-side mics to this unit.

### Connection settings

Set the jacks that the mid-side mics are connected to using the GENERAL SETTINGS screen > I/O SETTINGS > MS DECODE item.

### NOTE

- The mid-side decoding function can be used when inputting mid-side mics through the 3/4 input jacks and when using this unit to play an imported file recorded using mid-side mics. Turn the mid-side decoding function off to not use it.
- Always stereo-link the inputs to which mid-side decoding is applied. See "Using the STEREO LINK function" on page 22 for operation procedures.

### Adjusting mid and side levels

1. Launch the MANUAL app, and open the MIXER screen. The pan settings for the tracks selected for MS DECODE will become the MS decode setting.
2. Tap the MS decode setting, and slide the slider left and right to adjust the width of the sound. At 0, the sound will be 100% mid (M). The amount of side (S) increases with the value.

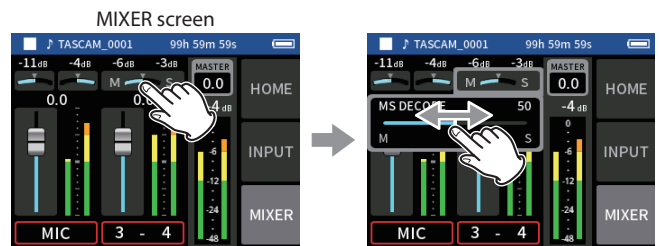

Tap the MS decode setting.

Slide the slider left and right to adjust the width of the sound.

When an AK-BT1 Bluetooth adapter is connected to the Bluetooth device connector of this unit, this unit can be controlled from an iOS/Android device using a controller app.

## 14-1 Installing the dedicated controller app

1. Connect the device to the Internet.
  2. Search for "Portacapture Control" on Google Play for an Android device or on the App Store for an iOS device. Then, download and install it.
- Please be aware that you are responsible for any transmission costs related to Internet connection.

## 14-2 Connecting with this unit using Bluetooth

1. Remove the cover from the Bluetooth connection device port on this unit, and install an AK-BT1 in it.

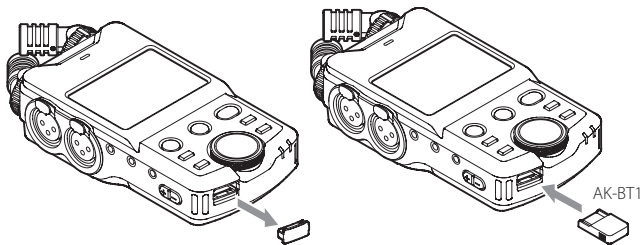

- Insert it so that the connector is toward the screen.

2. Enable Bluetooth connection on the smartphone or tablet.

### CAUTION

- Do not execute pairing from the Bluetooth device list screen of an iOS/iPadOS or Android device.

Always launch Portacapture Control and use it for pairing.

- When using an Android device, set Location to "On", and set "Location permission" for Portacapture Control to "Allow all the time" or "Allow only while in use".

### NOTE

Refer to the operation manual of the Bluetooth device for procedures.

3. Use the smartphone or tablet to launch Portacapture Control.

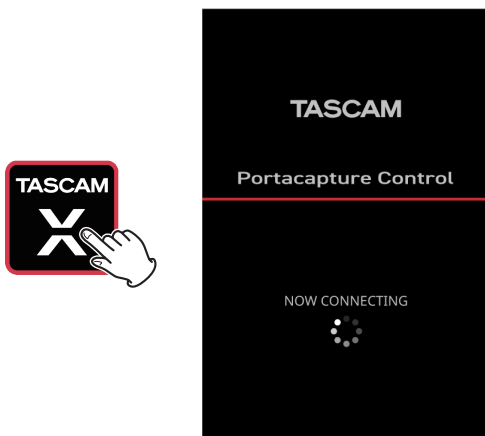

Bluetooth device screen

4. If the unit is not turned on, turn it on.
5. On the unit, turn the GENERAL SETTINGS screen > OTHER SETTINGS page > BLUETOOTH item on.

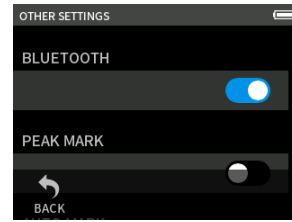

The AK-BT1 access indicator (blue) shows the connection status.

Indicator	Status
Unlit	Not paired
Blinking	Waiting to pair
Lit	Paired

When connection completes, the display of the smartphone or tablet will automatically switch to the operation screen.

## 14-3 Using the dedicated smartphone app

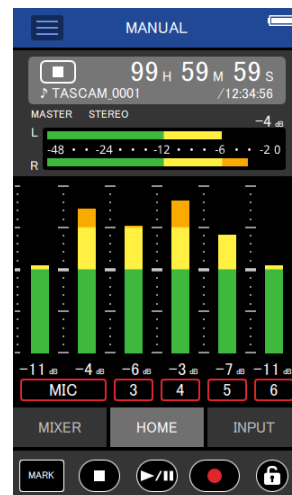

The four buttons at the bottom of the screen correspond to the physical buttons on the unit, and tapping them performs the same functions.

MARK	MARK button
■	HOME[■] button
▶/	▶/   button
●	REC [●] button

### NOTE

- Monitoring recording is not possible on paired devices. Use the headphone jack on the unit.
  - Touch and hold the to activate the hold function, which prevents operation from Portacapture Control. In this state, the buttons and touchscreen on the unit can still be operated. Touch and hold the when the hold function is active to deactivate it.
  - In the following circumstances, the touchscreen on the unit and the app screen on the smartphone will not be synchronized. Only the screen on the operated device will be updated.
    1. GENERAL SETTINGS screen 2nd level and deeper
    2. BROWSE screen 2nd level and deeper
    3. Moving to MANUAL/PODCAST app right tabs
    4. Moving to PLAY screen bottom tabs
    5. Detailed settings when tapping counter area
- In addition, when touch operations are conducted on the following

## 14 - Controller app

screens, the screen on the device that was not being used will show the progress and will not respond to touch operations.

1. INPUT SETTINGS
2. INPUT SELECT
3. PAD SETTINGS

- Even if the display does not update, the setting operated by touch will be applied to the unit.

---

## 15-1 Adjusting gain differences between built-in mics (mic trim function)

---

Set this with the GENERAL SETTINGS screen > I/O SETTINGS page > MIC TRIM item.

This adjusts the sensitivity of the built-in mics.

Use this function to make adjustments when the volumes of the left and right built-in mics are noticeably different because the source cannot be recorded from the front, for example.

### Input 1

Options: -3 dB, -2 dB, -1 dB, 0 dB (default value), 1 dB, 2 dB, 3 dB

### Input 2

Options: -3 dB, -2 dB, -1 dB, 0 dB (default value), 1 dB, 2 dB, 3 dB

---

## 15-2 XRI function overview

---

This can be set using the GENERAL SETTINGS screen > SYSTEM page > XRI item.

When this is on, files recorded in WAV format will have recording setting information, including input volumes, saved in them as XRI (eXtended Recording Information) data.

- The XRI data recorded can be checked on the FILE INFORMATION screen. ("Viewing file details (FILE INFORMATION)" on page 46)

### NOTE

XRI data cannot be saved when recording MP3 files.

---

## 15-3 Showing various information

---

Select the GENERAL SETTINGS screen > SYSTEM page > INFORMATION item.

### CARD

This shows information about the microSD card.

### SYSTEM

This shows the firmware and hardware versions.

---

---

## 15-4 Resetting the date and time

---

Select the GENERAL SETTINGS screen > SYSTEM page > DATE/TIME item, and adjust the settings. See "Setting the language, date and time" on page 17 for operation procedures.

---

## 15-5 Resetting the language

---

Select the GENERAL SETTINGS screen > SYSTEM page > LANGUAGE item, and adjust the setting.

### NOTE

Turn the unit on while pressing and holding the HOME button on the unit to open the language selection screen.

---

## 15-6 Resetting the unit to its factory defaults

---

Select the GENERAL SETTINGS screen > SYSTEM page > INITIALIZE item, and conduct initialization.

---

## 15-7 Formatting microSD cards

---

Select the GENERAL SETTINGS screen > SYSTEM page > MEDIA FORMAT item, and conduct formatting. See "Formatting (initializing) microSD cards" on page 18 for operation procedures.

---

## 15 - Various settings

---

### 15-8 Using the automatic power saving function

---

This can be set using the GENERAL SETTINGS screen > POWER/DISPLAY page > AUTO POWER item.

When on, the unit automatically turns off after 30 minutes have elapsed since the last activity or operation.

#### NOTE

This function only works when the unit is stopped. This function will not cause the unit to turn off during recording or playback.

---

### 15-9 Selecting the power source

---

This can be set using the GENERAL SETTINGS screen > POWER/DISPLAY page > POWER SOURCE SELECT item.

#### BATTERY

Operate using battery power. Do not use USB power supply.

#### AUTO (DEFAULT)

USB power supply will be used when available.

#### CAUTION

When connecting this unit with an iOS device, set this to BATTERY.

#### NOTE

Always put batteries in this unit before selecting BATTERY as the power source.

---

### 15-10 Setting the AA battery type (BATTERY)

---

This can be set using the GENERAL SETTINGS screen > POWER/DISPLAY page > BATTERY item.

Use this to set the type of battery used.

This setting is used to show the amount of remaining battery charge and determine if the unit has enough power for normal operation.

#### ALKALI

Alkaline batteries (default)

#### Ni-MH

Nickel-metal hydride batteries

#### LITHIUM

Lithium batteries

---

### 15-11 Power saving (energy conservation) mode

---

This can be set using the GENERAL SETTINGS screen > POWER/DISPLAY page > POWER SAVE MODE item.

#### POWER SAVE MODE

When POWER SAVE MODE is ON, the following six functions are restricted in order to reduce energy consumption.

- Only 44.1 kHz or 48 kHz can be selected as the sampling frequency in the recording settings. 96 kHz and higher cannot be selected.
- Phantom power is turned off. Condenser mics with balanced connections to the XLR jacks cannot be used.
- The display backlight time is fixed at 30 seconds.
- The display brightness is fixed at the standard level.
- The PEAK LED indicator at the bottom of the unit will not light.
- The display contrast is fixed at 10.

#### BACKLIGHT

This sets the display backlight.

OFF: Backlight always off

5–30 sec: Backlight turns off automatically after set time without operation

ALWAYS: Backlight always on

#### NOTE

The BACKLIGHT setting is only used when the unit is running on batteries. The backlight always stays lit when running on USB bus power.

#### BRIGHTNESS

This sets the display brightness.

#### INDICATORS

This sets how the REC and PEAK indicators light.

ALL ON: Both REC LED and PEAK LED light.

PEAK LED OFF: The PEAK LED will not light.

REC LED OFF: The REC LED will not light.

ALL OFF: Both REC and PEAK LEDs will not light.

#### CAUTION

POWER SAVE MODE will not be turned off automatically. When switching to a power supply with 1.5 A current or higher, turn the POWER SAVE MODE off as necessary.

#### NOTE

When the POWER SAVE MODE setting is off, BACKLIGHT, BRIGHTNESS and INDICATORS settings can be made.

---

### 15-12 Adjusting the display contrast (CONTRAST)

---

This can be set using the GENERAL SETTINGS screen > POWER/DISPLAY page > CONTRAST item.

Slide the slider left and right to set the contrast between 0 and 20.



15-13 MENU

GENERAL SETTINGS

Category	Menu item	Settings	Reference	
REC SETTINGS	FILE FORMAT	WAV (default), MP3	page 36	
	WAV FILE FOR-MAT	SAMPLE		44.1kHz, 48kHz (default), 96kHz
		BIT DEPTH		16bit, 24bit (default), 32-bit float
	MP3 FILE FOR-MAT	SAMPLE		44.1kHz, 48kHz (default)
		BIT DEPTH/BIT RATE	128Kbps, 192kbps, 256kbps, 320kbps (default)	
	REC PAUSE	OFF (default), ON	page 26	
	AUTO REC	OFF (default), ON	page 36	
	- START LEVEL	OFF, -6dB, -12dB (default), -24dB, -48dB		
	- END LEVEL	OFF, -6dB, -12dB, -24dB, -48 dB (default)		
	- END DELAY	1sec, 2sec, 3sec, 4sec, 5sec (default)		
	- END MODE	SAME FILE (default), NEW FILE		
	DUAL REC	OFF (default), MP3, FLOAT	page 37	
	PRE REC	OFF (default), ON	page 37	
TIME FILE INCREMENT	OFF (default), 5 min, 10 min, 15 min, 30 min, 60 min	page 37		
I/O SETTINGS	PHANTOM voltage	+24V, +48V (default)	page 25	
	PLUG IN POWER	OFF (default), ON (STEREO), ON (MONO)		
	MIC TRIM		page 55	
	- MIC L	-3dB, -2dB, -1dB, 0dB (default), 1dB, 2dB, 3dB		
	- MIC R	-3dB, -2dB, -1dB, 0dB (default), 1dB, 2dB, 3dB		
	SPEAKER	OFF (default), ON	page 21	
	MS DECODE	OFF, TRACK 1-2, TRACK 3-4	page 52	
	REVERB	OFF (default), ON	page 24	
	- TYPE	LARGE HALL (default), SMALL HALL, ROOM, STUDIO, PLATE 1, PLATE 2		
	- SOURCE	TRACK 1-2, TRACK 3-4, MIX (default)		
- LEVEL	0 - 50 (default) - 100			
CAMERA SETTINGS	OUTPUT	LINE (default), CAMERA	page 49	
	- LEVEL	-10 - 0 dB (default)		
	AUTO TONE	OFF (default), HEAD, HEAD + TAIL	page 49	
	- LEVEL	-12dB, -18dB (default), -24dB -30dB, -36dB		
OTHER SETTINGS	BLUETOOTH	OFF (default), ON	page 53	
	PEAK MARK	OFF (default), ON	page 48	
	AUTO MARK	OFF (default), LEVEL, TIME	page 48	
	- LEVEL	-6dB, -12dB (default), -24dB, -48dB		
	- TIME	5min, 10min, 15min, 30min, 60min (default)		
	SD CARD READER	EXECUTE	page 50	

## 15 - Various settings

Category	Menu item	Settings	Reference
SYSTEM	INFORMATION	CARD	
		- TOTAL FILE	
		- TOTAL FOLDER	
		- TOTAL SIZE	
		- USED SIZE	
		- REMAIN SIZE	
		SYSTEM	
		- F/W	
	- H/W		
	XRI	OFF, ON (default)	page 55
	DATE / TIME	Set the date and time (yyyy / mm / dd HH : MM : SS)	page 55
FILE NAME	- TYPE: DATE (default), WORD	page 43	
	- WORD EDIT: TASCAM (default)		
	- FILE No. RESET: OFF, ON (default)	page 43	
	Exec		
LANGUAGE	ENGLISH (default), 日本語, FRANCAIS, ESPANOL, DEUTSCH, ITALIANO, 中文, 한글, русский язык	page 55	
INITIALIZE	EXECUTE	page 55	
MEDIA FORMAT	QUICK FORMAT, ERASE FORMAT	page 55	
POWER / DISPLAY	AUTO POWER SAVE	OFF, ON (default)	page 56
	POWER SOURCE SELECT	BATTERY, AUTO (default)	page 56
	BATTERY	ALKALI (default), Ni-MH, LITHIUM	page 56
	POWER SAVE MODE	OFF (default), ON	page 56
	- BACKLIGHT	OFF, 5sec, 10sec, 15sec, 30sec, ALWAYS (default)	
	- BRIGHTNESS	LOW, MID (default), HIGH	
	- INDICATORS	ALL ON (default), PEAK LED OFF, REC LED OFF, ALL OFF	
	CONTRAST	0 – 10 (default) – 20	page 56

### INPUT SETTINGS

Category	Menu item	Settings	Reference
INPUT GAIN	GAIN		page 24
	- MIC	LOW (0–36 dB), HIGH (14–50 dB)	
	- 3/4	LOW (0–35 dB), HIGH (22–57 dB) (in 0.5dB steps)	
	- MIC/EXT IN	0–38 dB (in 0.5dB steps)	
	- USB	–	
Individual input settings for inputs 1–4	STEREO LINK (excluding MIC/EXT IN)	Off (default), On	page 22
	INPUT		page 22
	- Input 1/2	MIC (default), EXT	
	- Input 3/4	MIC (default), LINE	
	PHANTOM (when 3/4 and MIC only)	Off (default), On	page 25
	AUTO GAIN	OFF (default), ON	page 22
	LOW CUT	OFF (default), 40Hz, 80Hz, 120Hz, 220Hz	page 23
	NOISE GATE	OFF (default), LOW, MID, HIGH	page 23
	LIMITER / COMP	OFF (default), LIMITER, COMPRESSOR	page 23
	EQ	OFF (default), VOICE, GUITAR, LOUD, VOCAL, MANUAL	page 23
PHASE INVERT	OFF (default), ON	page 23	

## Mixer

Category	Menu item	Settings	
MIXER	When MS DE-CODE is OFF	Level	-inf – 0dB (default) (in 0.5dB steps)
		Panning	L20 – C – R20
	When MS DE-CODE is ON	LEVEL	0 – 50 (default) – 100
		WIDE	0 – 50 (default) – 100
	Type of mix file (icon)	STEREO (default), MONO	

## BROWSE

Category	Menu item	Settings	Reference	
BROWSE	New folder	RENAME	page 44	
FOLDER	OPEN	EXECUTE	page 44	
	RENAME	EXECUTE	page 44	
	ALL FILES DELETE	EXECUTE	page 45	
	FOLDER DELETE	EXECUTE	page 45	
FILE	SELECT	The selected file becomes the current project, and the app used for recording appears on the Home Screen.	page 45	
	PLAY	EXECUTE	page 45	
	FILE INFORMATION	This shows file and track information	page 46	
	FILE DELETE	EXECUTE	page 46	
	TRACK DELETE	Track 1, 2, 3 or 4	page 46	
	CHANGE PROTECT	EXECUTE	page 46	
	RENAME	EXECUTE	page 46	
	MARK	CLEAR ALL MARKS	page 47	
	DIVIDE	DIVIDE		page 47
		AUTO DIVIDE - ALL MARK		
AUTO DIVIDE - TIME MARK				
NORMALIZE	EXECUTE	page 47		

## INPUT SELECT

Category	Menu item	Settings	Reference
INPUT SELECT	TRACK 1-2	1-2 (default), 3-4, USB, MIC/EXT IN	page 22
	TRACK 3-4	1-2, 3-4 (default), USB, MIC/EXT IN	

## LAUNCHER

Category	Menu item	Settings	Reference
ASMR	EXECUTE		page 28
MANUAL	EXECUTE		page 29
MUSIC	EXECUTE		page 31
VOICE	EXECUTE		page 32
FIELD	EXECUTE		page 33
PODCAST	EXECUTE		page 34



# 16- Changes made in firmware version updates

## 16-1 The following function have been added or changed since firmware version 1.10

- Support has been added for wireless timecode synchronization with compatible Atomos products , including AtomX Sync, UltraSync BLUE ATOMOS CONNECT and SHOGUN CONNECT.
- The audio interface now supports the 32-bit float format.
- The USB MIXMINUS function can now be used in the PODCAST app.
- In addition to built-in mic input, selecting PAD and USB input is now possible when using the PODCAST app.
- Input settings can now be saved and loaded in each recording app.
- Unit settings and recording app settings can now be saved and recalled with a single tap from the LAUNCHER screen.

### Support has been added for wireless timecode synchronization with compatible Atomos products , including AtomX Sync, UltraSync BLUE ATOMOS CONNECT and SHOGUN CONNECT.

Connecting an AK-BT1 Bluetooth adapter (sold separately) to the Bluetooth device port on this unit enables connection with and receiving timecode from Atomos devices, including AtomX SYNC, UltraSync BLUE. Received timecode is written to the files recorded by this unit. Using this timecode data simplifies the aligning of video and audio files created by multiple units.

#### NOTE

- The remote control app for this unit (Portacapture Control) cannot be used simultaneously with AtomX SYNC or UltraSync BLUE, for example.
- If the recording format is set to MP3, timecode cannot be added to recording files.

### Connecting AtomX SYNC, UltraSync BLUE and similar devices

1. Remove the cover from the Bluetooth connection device port on this unit, and install an AK-BT1 in it.
2. From this unit's GENERAL SETTINGS screen, open the OTHER SETTINGS screen, and select TIMECODE for BLUETOOTH.
3. Tap CONNECT on the TIMECODE Screen to search for and pair with a nearby AtomX SYNC, UltraSync BLUE or similar device. When pairing completes, "CONNECTED" will appear and information for the AtomX SYNC, UltraSync BLUE or other device will be shown.

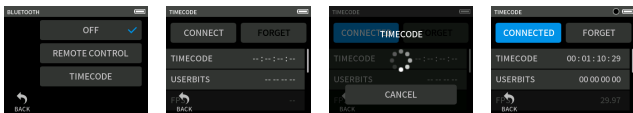

#### Example

TIMECODE	This shows the timecode as hours: minutes: seconds: frames.
USERBITS	This shows the user bits (date, time, scene number or other chosen data) set with the AtomX SYNC, UltraSync BLUE or other device.
FPS	This shows the frame rate.
DEVICE	This shows the name of the AtomX SYNC, UltraSync BLUE or other device.

### Disconnecting from an AtomX SYNC, UltraSync BLUE or other device

From this unit's GENERAL SETTINGS screen, open the OTHER SETTINGS screen, and select OFF for BLUETOOTH.

### Connecting a different AtomX SYNC, UltraSync BLUE or similar device

Unpairing first is necessary to switch connection from an already paired AtomX SYNC, UltraSync BLUE or other device to a different device.

1. From this unit's GENERAL SETTINGS screen, open the OTHER SETTINGS screen, and select BLUETOOTH TIMECODE.
2. Tap FORGET on the TIMECODE Screen to unpair with the device.
3. Tap CONNECT on the TIMECODE Screen to search for and pair with a different AtomX SYNC, UltraSync BLUE or similar device.

### Appearance when connected with an AtomX SYNC, UltraSync BLUE or similar device

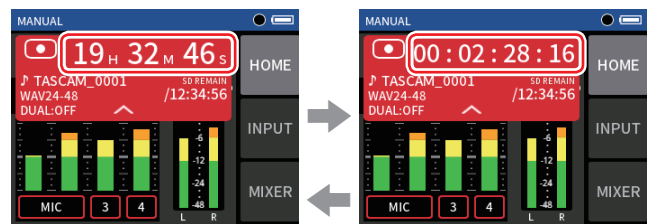

Displaying hours, minutes and seconds

Displaying received time code

Tap the project status bar to switch between displaying hours, minutes and seconds and received time code.

### Connection status

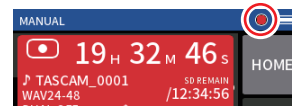

Blinking green		Receiving timecode from an AtomX SYNC, UltraSync BLUE or similar device
Blinking red		Running by itself based on the last received timecode
Unlit		Already paired, but not receiving timecode or running by itself

#### NOTE

- Timecode data can be shown in the same manner in all recording apps.
- Using overdubbing and punching in/out in the Manual app, timecode will be shown or added to recording files.
- When timecode is being received, the AK-BT1 LED will blink every second.

# 16 - Changes made in firmware version updates

## The audio interface now supports the 32-bit float format.

### When using with Windows

1. Install the ASIO driver for Portacapture (Ver 1.30 or later).  
Check the page for this product on the TASCAM website for details.  
<https://tascam.com/>
2. Launch the ASIO driver for Portacapture, and turn ON the 32-bit float function on the 32 bit float page.

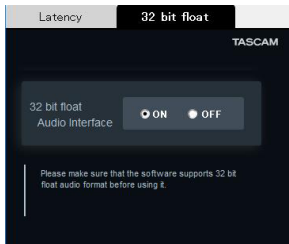

### When using with macOS

1. Open the Audio MIDI Setup app from the Applications folder.
2. Set the Portacapture X6 as the Sound Input and Sound Output device.
3. Change the input/output format to 32-bit Float.

#### NOTE

The standard OS driver will be used, so there is no do so need to install any software.

## The USB MIXMINUS function can now be used in the PODCAST app.

By using this function when conducting a telephone interview or remote recording with this unit connected by USB to a computer or smartphone, echo generation at the other end can be prevented.

### MIXMINUS function off (normal state)

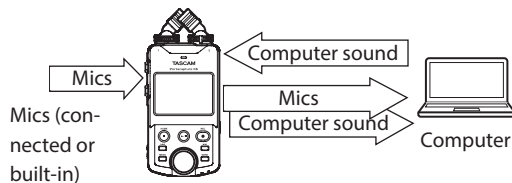

### MIXMINUS function on

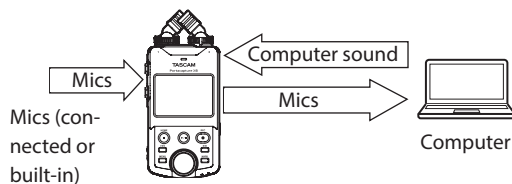

### Turning the MIXMINUS function on

1. When the PODCAST app is stopped, press the MENU button.
2. Tap the USB MIXMINUS ON icon.

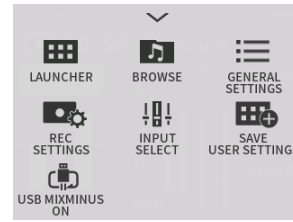

The MIXMINUS function is activated and the MIXMINUS icon will be shown on the Home Screen.

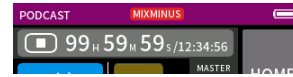

### Turning the MIXMINUS function off

1. When the PODCAST app is stopped, press the MENU button.
2. Tap the USB MIXMINUS OFF icon.

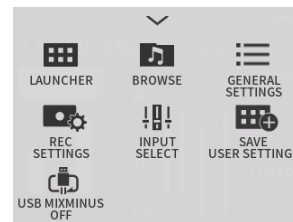

The MIXMINUS function is deactivated and the MIXMINUS icon will disappear from the Home Screen.

#### NOTE

When MIXMINUS is on, mix cannot be selected as the reverb input.

## In addition to built-in mic input, selecting PAD and USB input is now possible when using the PODCAST app.

Using this function enables recording and streaming voices from guests communicating through a device connected by USB.

### Switching to SOUND PAD or USB use

1. When the PODCAST app is stopped, press the MENU button.
2. Tap the "INPUT SELECT" icon.



3. Tap "TRACK 3-4".  
"PAD" or "USB" can be selected.

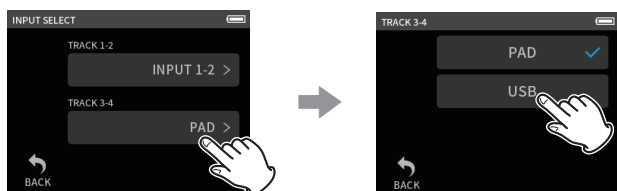

#### NOTE

If "USB" is selected for "Track 1-2", "Track 3-4" will automatically be set to "PAD".

- If "USB" is selected, the Home Screen will change and 4-track recording will be possible for the inputs chosen for "Track 1-2" and the USB inputs.

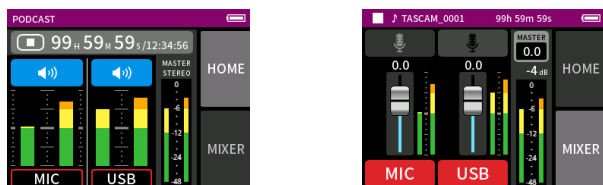

#### NOTE

If "USB" is selected for "Track 3-4", SOUND PAD setting and use will be disabled.

The mute function, which cannot be used with the SOUND PAD function, and input on/off switching are enabled.

## Input settings can now be saved and loaded in each recording app.

Up to three dynamics presets can be saved to be shared and used by all recording apps.

### Saving presets

1. Open the INPUT SETTINGS Screen for the input channel with settings that you want to save.
2. Tap PRESET SAVE.

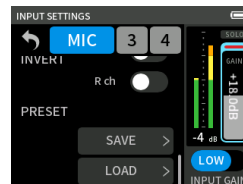

3. When the SAVE PRESET Screen opens, tap the save destination preset.

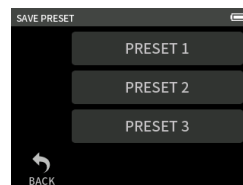

4. When a confirmation pop-up opens, tap YES.



### Loading presets

1. Open the INPUT SETTINGS Screen of the input channel for which you want to load settings.
2. Tap PRESET LOAD.  
The LOAD PRESET Screen will open.

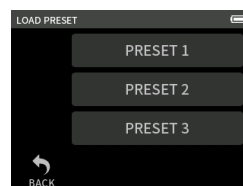

3. Tap the preset to load.

### Saving/loading dynamics presets in the MUSIC and FIELD apps

1. On the Home Screen of the MUSIC/FIELD app, select DYNAMICS PRESET.
2. Scroll to the bottom of the DYNAMICS PRESET Screen, and tap a preset to load it.



Tapping the SAVE icon at the bottom right of the DYNAMICS PRESET Screen will open the SAVE PRESET Screen (INPUT SETTINGS Screen) where presets can also be saved.

# 16 - Changes made in firmware version updates

### NOTE

- Up to three presets can be saved.
- The parameters saved and their default values are as follows.
  - GAIN LOW/HIGH: LOW
  - GAIN: -18.0 dB
  - Auto gain: OFF
  - Low cut: OFF
  - Noise Gate: OFF
  - Limiter/comp: OFF
  - EQ: OFF
- Saved presets can be used with other recording apps.

### Unit settings and recording app settings can now be saved and recalled with a single tap from the LAUNCHER screen.

All unit settings can now be saved, and apps can be launched with a single tap from the LAUNCHER.

### Saving user settings

1. Press the MENU button in the recording app with the settings that you want to save.
2. Tap the SAVE USER SETTINGS icon.

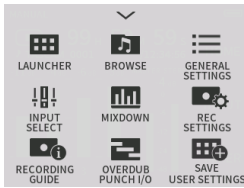

3. When a confirmation pop-up opens, tap YES.

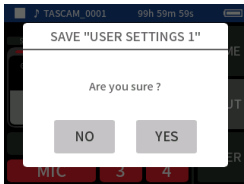

The recording app with the user settings applied will be shown in the LAUNCHER.

### Recalling user settings

Tap a USER SETTINGS icon in the LAUNCHER. This will launch the app with the saved settings.

### Deleting user settings

1. Continuously press the touchscreen when the LAUNCHER is open. This activates user setting deletion mode.

### NOTE

If sliding occurs while pressing and holding, lift the finger once before pressing and holding again.

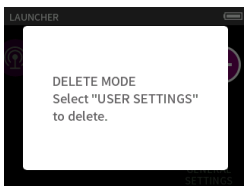

2. Tap the icon for the user setting you want to delete.

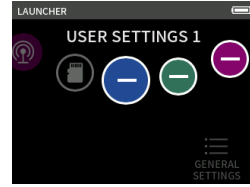

3. When a confirmation pop-up opens, tap YES.



4. Tap anywhere besides a USER SETTINGS icon to end user setting deletion mode.

### NOTE

A maximum of three user settings can be saved.



## 16-2 The following functions have been added or changed since firmware version 2.00

The following functions have been added or changed from firmware version 2.00.

- A POCKET STUDIO app has been added.
- A real-time MIXDOWN function has been added.
- A METRONOME app has been added.
- A TUNER app has been added.
- A master file recording on/off function has been added.
- A EXPANDED PRE REC function has been added to the FIELD app.

### A POCKET STUDIO app has been added.

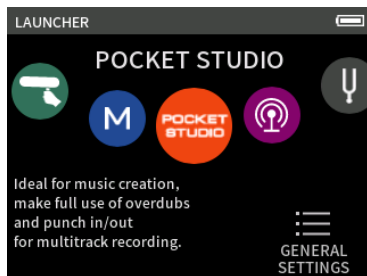

The POCKET STUDIO app is a recording app that, in addition to the OVERDUB and PUNCH I/O functions of the MANUAL app, also has AUTO PUNCH, METRONOME and TUNER functions. This makes multitrack recorder operation easy for the current project if it is no more than 15 minutes long. To start the POCKET STUDIO app, select the desired project on the BROWSE screen or use the NEW PROJECT button to create a new project.

#### NOTE

Projects with the following characteristics cannot be loaded by the POCKET STUDIO app.

- Projects with sampling frequencies of 96 kHz or higher
- Projects that use MP3 recording format
- Projects with recording times that exceed 15 minutes

### Screen overview

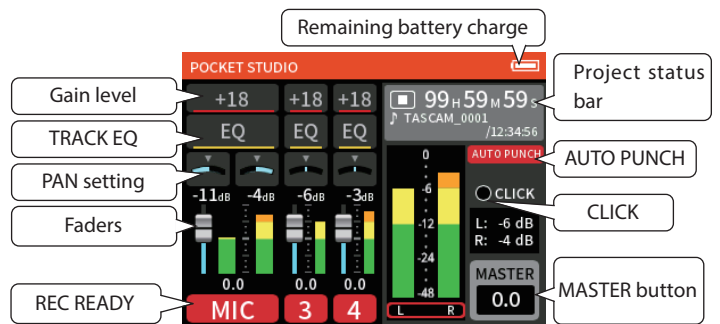

### Shortcut Menu

Press the MENU button on the bottom left of the unit to show the following menu.

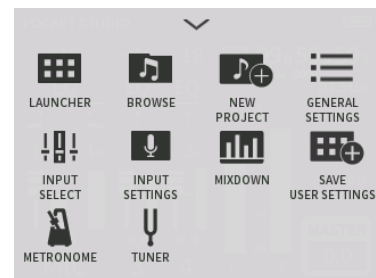

#### LAUNCHER

App switching and unit settings (page 10)

#### BROWSE

File operations (page 44)

#### NEW PROJECT

New project creation (page 67)

#### GENERAL SETTINGS

Additional settings (page 57)

#### INPUT SELECT

Track number and input jack assignments (page 22)

#### INPUT SETTINGS

(page 22)

#### MIXDOWN

(page 68)

#### SAVE USER SETTINGS

(page 64)

#### METRONOME

Settings for the metronome used in the POCKET STUDIO app (page 69)

#### TUNER

(page 70)

#### NOTE

In the POCKET STUDIO app, the following limitations apply to the GENERAL SETTINGS.

#### REC SETTINGS

No settings can be made.

#### I/O SETTINGS

SPEAKER and MS DECODE cannot be set.

#### CAMERA SETTINGS

AUTO TONE cannot be set.

## 16 - Changes made in firmware version updates

### Project status bar

Tap the project status bar to show additional details.

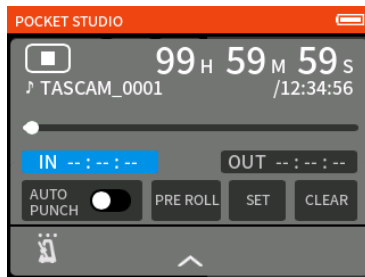

Set the AUTO PUNCH function on this screen. ("AUTO PUNCH function" on page 67)

### MASTER button

Tap the MASTER button to show MASTER FADER, STEREO/MONO and REC READY settings.

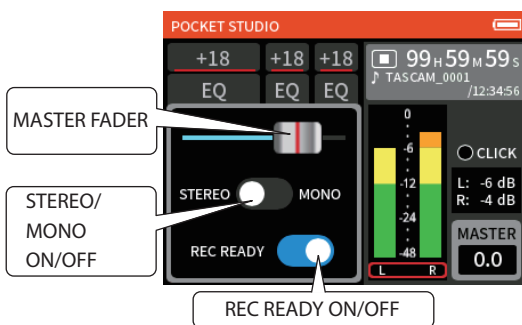

### MASTER FADER

Slide this left and right to adjust the level.

### STEREO/MONO

Use this to switch between stereo and mono.

### REC READY

Use this to turn REC READY on and off.

Master files will not be recorded when off. ("A master file recording on/off function has been added." on page 70)

### CLICK indicator

This lights green when click sound output is set.

When the metronome is operating, this will blink green at the set tempo, blinking red on the first beat.

### AUTO PUNCH indicator

This appears when the AUTO PUNCH function is on.

### TRACK EQ

In the POCKET STUDIO app, unlike other apps, EQ is applied to tracks rather than inputs.

- When recording, sound is recorded before EQ is applied to track files.
- Since EQ is applied to the tracks, it can be used on SD card playback and USB input unlike in other apps.

### REC READY

These show track states.

Tracks can also be tapped to enable and disable them for recording.

The table below shows track states and whether or not they are being monitored.

Color	State	Monitoring					
		Stopped		Recording		Playing	
		INPUT	SD	INPUT	SD	INPUT	SD
Red	Recording paused	✓	–	✓	–	✓	✓
Green	File loaded	–	–	–	✓	–	✓
Gray	Unused	–	–	–	–	–	–

## AUTO PUNCH function

Recording can be activated automatically between punch in (recording start) and out (recording stop) points set in advance.

By turning on the AUTO PUNCH function and pressing the record button, playback will start and continue until the punch in point (pre-roll) where recording will start.

Then, when the punch out point is reached, recording will stop but playback will continue for two more seconds.

### Screen overview

Open additional details from the project status bar in the POCKET STUDIO app to make auto punch settings ("Project status bar" on page 66).

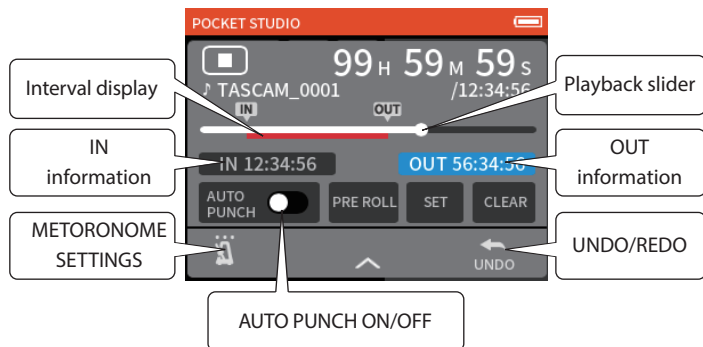

### IN information

This shows the recording starting point.

Tap this to make the background blue, showing that it is selected.

### OUT information

This shows the recording stopping point.

Tap this to make the background blue, showing that it is selected.

### Playback slider

Move left and right to adjust the position.

### Interval display

When both the recording starting and stopping positions are set, this interval becomes red.

### AUTO PUNCH

This turns the AUTO PUNCH function on and off.

When this is on, the AUTO PUNCH icon will appear on the Home

Screen. ("AUTO PUNCH indicator" on page 66)

### PRE ROLL

When using automatic punch in, the amount of playback time before the punch in point can be set (pre roll).

OFF: The playback position will not be moved to a point before the punch in point. Moving the playback position manually to before the punch in point will be necessary.

1 to 10 sec.: Playback will start this many seconds before the punch in point. (Default: 2 sec.)

### SET

Tap this when the IN or OUT information is selected to set the starting or stopping position to the current position of the playback slider.

### CLEAR

Tap this when the IN or OUT information is selected to clear that setting.

### METRONOME SETTINGS

Settings for the metronome used in the POCKET STUDIO app. ("A METRONOME app has been added." on page 69)

## UNDO

The last recording operation can be undone if you want to re-record, for example.

## REDO

After undoing, this restores the previous operation and returns to the state before undoing.

### NOTE

If a project is loaded or the unit is turned off, the data used for UNDO and REDO operations will be lost, making them no longer possible.

## Rehearsing punching in and out

When the auto punch function is on, punching in and out can be rehearsed before using it to record by pressing the play button. In rehearsal, recording will not occur, but monitoring will be the same as if recording.

## NEW PROJECT

Use this to create a new project.

The following recording formats can be selected.

- 44.1kHz / 16bit
- 44.1kHz / 24bit
- 44.1kHz / 32bit float
- 48kHz / 16bit
- 48kHz / 24bit
- 48kHz / 32bit float

# 16 - Changes made in firmware version updates

## A real-time MIXDOWN function has been added.

By mixing down in real time, new mix files can be created while adjusting the volume levels and panning settings of each track in an existing project during playback.

The real-time MIXDOWN function can be used in the POCKET STUDIO app.

1. When the POCKET STUDIO app is stopped, press the MENU button at the bottom left of the unit.

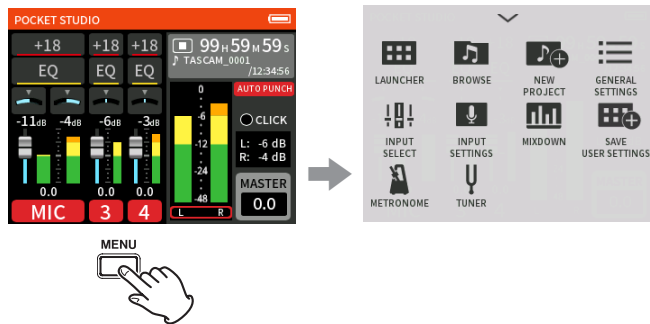

2. Tap the MIXDOWN icon.

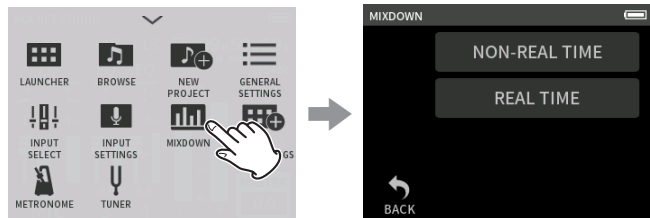

3. Tap REAL TIME.

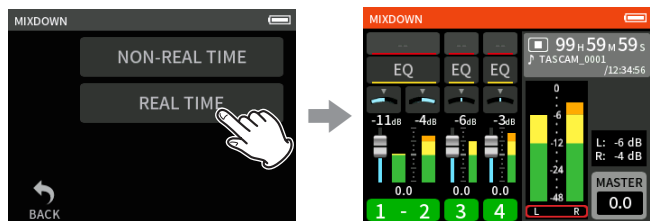

This will open the real-time MIXDOWN Screen.

4. Press the record button.

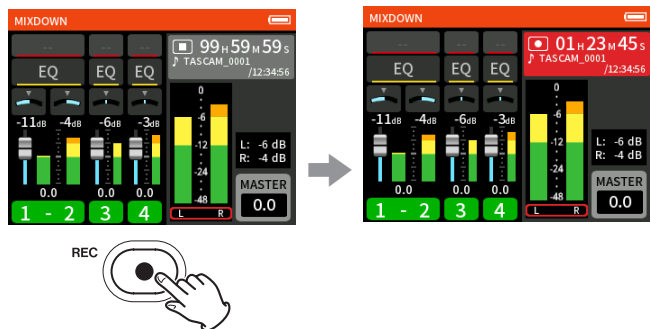

This will start the mix down. Equalizer, fader and other settings can be adjusted for each track while mixing down.

5. Press the stop button when done with the mix down.

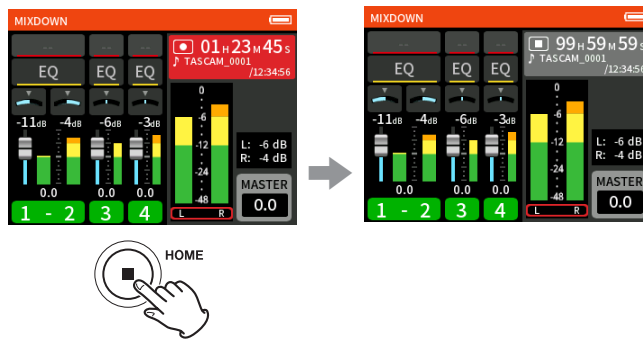

A master file of the mix will be created in a new project.

6. Press the MENU button at the bottom left of the unit.

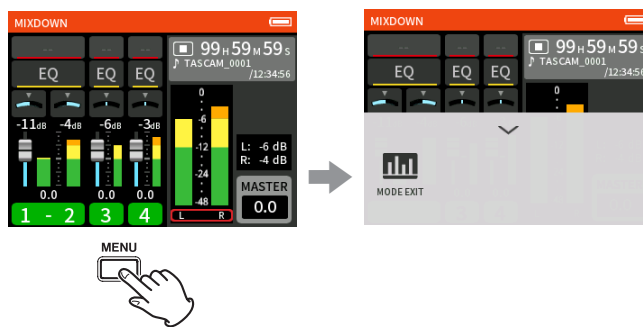

7. Tap the MODE EXIT icon.

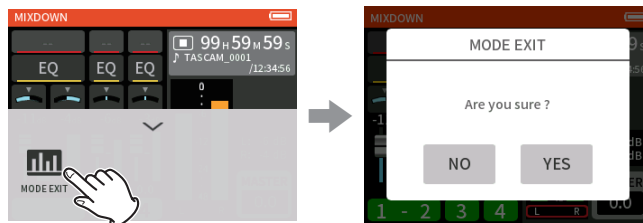

A message confirming execution of the MODE EXIT operation will pop up.

8. Tap YES.

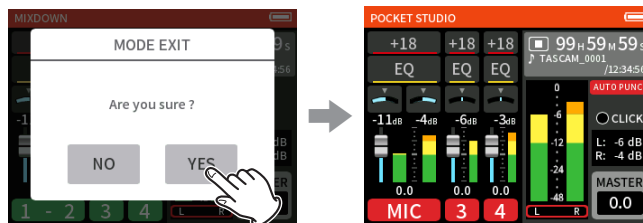

Return to the POCKET STUDIO app HOME screen.

### NOTE

- OFFLINE mode is the same as the mixdown function in the MANUAL app. ("Mixdown function" on page 52)
- Mixing down is possible in the same manner by setting REC READY to "OFF" on all tracks except the MASTER on the Home Screen of the POCKET STUDIO app. Instead of creating a new project, however, the MASTER will be overwritten.

## A METRONOME app has been added.

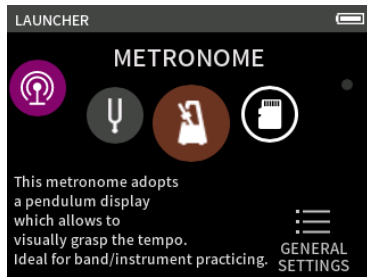

Click sound and metronome settings can be made.



Press the START button to run the metronome. Press the button again to stop it.

### TAP button

Tap this button to input tap tempo. Tap this button several times at the desired speed (bpm) to set the tempo.

### Tempo

The Tempo can be set in a range from 20 to 250 (BPM). (Default: 120)

### Volume

This sets the click volume.

### Settings

Tap this to open a settings screen.

## Settings screen

Settings available in the POCKET STUDIO app

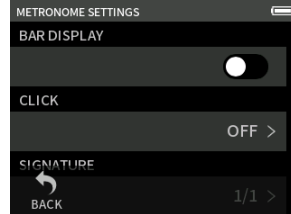

Settings available in the METRONOME app

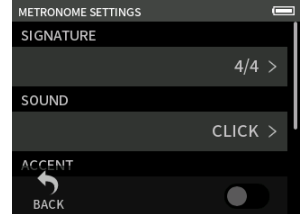

### Bar display\*

When on, the format of the counter on the Home Screen changes from "00h00m00s" (hours, minutes, seconds) to "0000-01" (bars and beats).

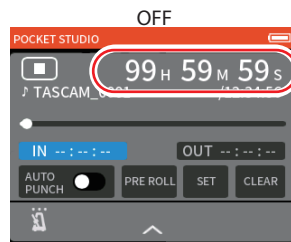

00h00m00s format



0000-01 (bars and beats) format

### CLICK\*

This sets the output of the click sound. (Default: OFF)

OFF: No click sound is output

REC: Output while recording

REC&PLAY: Output while recording and playing

### SIGNATURE

This sets the time signature. (Default: 4/4)

1/1 – 12/8

### SOUND

This sets the click sound. (Default: CLICK)

CLICK

STICK

BELL

### ACCENT

This sets whether the metronome has an accent or not.

\* The bar display and click are only shown when making settings in the POCKET STUDIO app.

# 16 - Changes made in firmware version updates

## A TUNER app has been added.

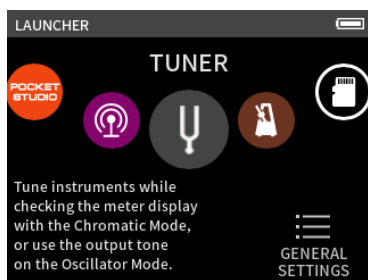

This tuner has a chromatic tuning mode, which allows instruments to be tuned while checking a tuning meter, and an oscillator mode that outputs a standard pitch.

### Tuning by pitch

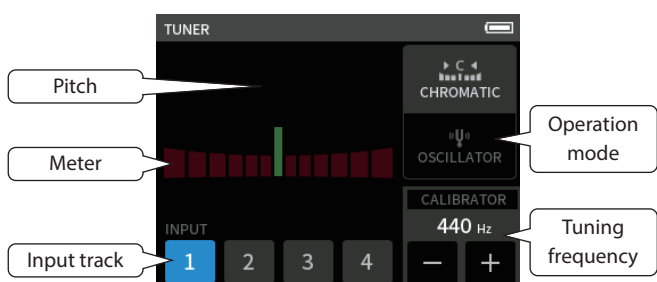

1. Set the operation mode to CHROMATIC.
2. Set the tuning frequency.
3. Select a track to use for tuning.
4. Input a sound from the instrument to be tuned. The closest pitch name will be shown above the center of the meter. Tune the instrument so that the target pitch name appears and the center of the tuner lights. A bar appears to the left or right of center if the sound is lower or higher than the target pitch. The meter extends further as the discrepancy becomes larger.

### Tuning by standard pitch

Tuning tones can be output from the LINE OUT jack in a three-octave range (C3 – B5).



1. Set the operation mode to OSCILLATOR.
2. Set the pitch.
3. Set the output level.
4. Tap the TAP icon to turn tone output on.

## A master file recording on/off function has been added.

A setting can now be made so that master files are not recorded. The master file recording on/off function can be used in the MANUAL and POCKET STUDIO apps.

### MANUAL app HOME screen example



When master file recording is on

When master file recording is off

### MANUAL app MIXER screen example



When master file recording is on

When master file recording is off

### Setting this function

1. Tap the MASTER button in the app.

### MANUAL app example



2. Turn off REC READY.

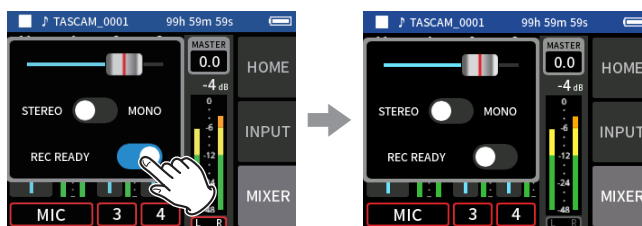

This disables master file recording.

### NOTE

- When REC READY is off, the recording project will become one that has only track files. It will not have a master file. Projects that do not have master files cannot be played back in 2-channel apps or the browser.
- If MP3 format is selected, master file recording will be turned on.

## A EXPANDED PRE REC function has been added to the FIELD app.

This function enables audio to be recorded before the recording button is pressed. This allows the capture of desired sounds that occur suddenly, for example, the singing of birds.

After tapping the EXPANDED PRE REC button, up to about 8 seconds before the REC [●] button is pressed can be recorded.

1. Tap the EXPANDED PRE REC button when stopped.

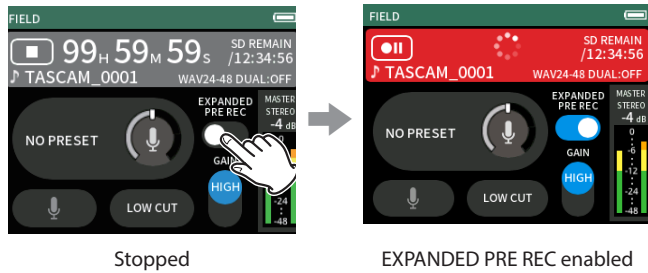

This enables EXPANDED PRE REC, and the unit will start continuously recording for up to about 8 seconds.

2. Press the REC [●] button at the desired time.



The 8 seconds just before pressing the button will be saved as a file. At the same time, the unit will start recording a new interval. As necessary, press the REC [●] button again.

### NOTE

After starting recording, if the REC [●] button is pressed before 8 seconds, a file with the length before pressing will be saved.

3. To stop recording, tap the EXPANDED PRE REC button or HOME [■] button.

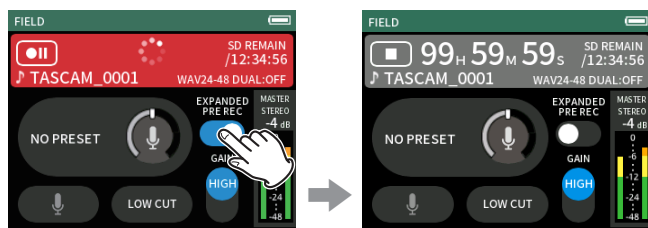

or



This disables EXPANDED PRE REC and stops the recorder.

### CAUTION

When the recorder is returned to a stopped state, unsaved EXPANDED PRE REC content will be lost.

# 17 - Messages

The following is a list of pop-up messages.

Refer to this list if one of these pop-up messages appears on the Portacapture X6 and you want to check the meaning or determine a proper response.

Message	Details and response
Hold On	Buttons have been disabled by the HOLD switch.
No Card	Load a microSD card.
Card Error	The microSD card could not be recognized. Change the microSD card.
Card Full	The microSD card has no remaining capacity.
Format Error Format Card	The microSD card might not be formatted properly, or it might be broken. Tap the screen to start formatting. Formatting will erase all data on the microSD card.
Invalid Card Change Card	Something might be wrong with the microSD card. Change the microSD card.
MBR ERROR Init CARD	The microSD card might not be formatted properly, or it might be broken. Tap the screen to start formatting. Formatting will erase all data on the microSD card. If formatting is not possible, change the microSD card.
Write error Recording will continue	Writing to the microSD card timed out. This has caused audio to be interrupted and noise to occur. A BOF mark was added at the point when audio was interrupted.
Card slow Check BOF mark	microSD card writing performance has become worse. A BOF mark has been added at the point when audio was interrupted because writing to the microSD card timed out. Check the audio around the BOF mark. Execute the erase format function or change the microSD card.
Invalid SysFile Make Sys File	The system file required to operate this unit is invalid. Tap the screen to create a system file.
Non- Supported	See the Reference Manual for file formats that this unit can use. ("Recording/playback formats" on page 75)
File Num Full	Recording is not possible because the total number of folders and files would exceed the limit of 5000.
File Not Found	The file was not found or might be damaged. Check the relevant file.
Cannot delete because file protected	Remove protection from a file before trying to delete it.
Cannot divide because file too short	The file is too short, so it cannot be divided.
MP3 files cannot be divided	MP3 files cannot be divided.
No marks so cannot divide	Files that do not have marks cannot be divided with this function.
Can't divide Short interval	Mark division will not work when the interval between marks is two seconds or less.
Can't divide No file	There is no audio file.
Cannot divide because file name invalid	Division is not possible because the file name would exceed the limit of 200 characters. Use a computer to change the file name.
Can't delete Not empty	Folders that contain files cannot be deleted. Delete all the files in the folder and try again.

Message	Details and response
No XRI data	No XRI data has been saved in the file. Turn the XRI data recording function ON before starting recording. XRI data cannot be saved when recording MP3 files.
Adding marks not possible because file protected	Marks cannot be added because the file is protected from writing. Remove protection from a file to add marks to it.
Can't MARK File length	Marks cannot be added because the file is too short.
I/O Too Short	The IN and OUT points are too close together. Set them with at least 1 second between them.
Dual format not possible	MP3 dual format recording cannot be used when the sampling frequency is 96 kHz.
File error	If any of these errors occurs, turn the unit off and restart it.
Error occurred	
Playback Error	If the unit cannot be turned off, remove the batteries, and disconnect the AC adapter (TASCAM PS-P520U, sold separately).
Writing Failed	
System error XX (XX is a number)	If these error messages continue to appear frequently, please contact a TASCAM customer support service.
USB FS Mismatch	The sampling frequency settings of this unit and the computer are not the same. Change the setting of one so that they are the same.
Already used in another pad	The same pad data cannot be used for two sound pads at the same time.
Battery is overheated. Change to USB power supply.	The internal temperature has become higher when using AA batteries. You can continue to use the unit by powering it with a USB connection.
Device is overheated. Turn off the power.	The internal temperature has become higher. The system will shut down automatically.
The USB power supply is less than 1500 mA.	Use of a function that cannot be used when power is less than 1500 mA was attempted. Connect an external power supply that can provide at least 1500 mA, or set the unit to operate using battery power and disable energy-saving mode.
No track selected	No recording track has been selected. Turn input on for tracks to be recorded on the Input Screen. ("Setting input levels" on page 30)



If you are having trouble with the operation of this unit, please check the following before seeking repair. If these measures do not solve the problem, please contact the store where you bought the unit or TASCAM customer support service.

## Power will not turn on

- Confirm that batteries are installed correctly.
- Confirm that the TASCAM PS-P520U AC adapter (sold separately) power plug and the USB connector are securely connected. The unit might not operate properly through a USB hub.

## The unit turns off automatically

- Confirm that the automatic power saving function is disabled.
  - The automatic power saving function can be turned on/off using the GENERAL SETTINGS screen > POWER/DISPLAY page > AUTO POWER SAVE item.
  - Since this unit complies with the European Standby Power Regulations (ErP), the automatic power saving function operates regardless of whether the unit is being powered by an AC adapter or batteries. If you do not want to use the automatic power saving function, set it to OFF. (The factory default setting is ON, which turns off the unit when it has not been used for 30 minutes.)

## Operation is not possible using the unit controls

- Confirm that the  $\phi$ /I/HOLD switch is not set to HOLD.
- Unit operations are not possible when SD CARD READER appears on the screen.

## The microSD card is not recognized.

- Confirm that the microSD card is inserted completely.
- Format it with a computer, and reinsert it.

## No sound is output

- Confirm the unit's headphone/speaker output level.
- Check the monitoring system connections and volume level.
- No sound is output from the speaker in the following conditions.
  - The  $\Omega$ / $\square$  (headphone/speaker) volume is set to "0".
  - The GENERAL SETTINGS screen > I/O SETTINGS page > SPEAKER item set to Off. ("Using the built-in speaker" on page 21)
  - The unit is recording or in recording standby
  - The LINE OUT or headphones jack is in use.

## Recording is not possible

- Confirm that the microSD card has enough open space.
- Recording becomes impossible when the total number of files reaches 5000.

## The input sound is extremely quiet or loud

- Check input level settings. ("Adjusting input gain (GAIN)" on page 24)
- Check the output levels of connected external equipment.

## A file cannot be erased

- A protected (read only) file cannot be erased.

## This unit's files do not appear on the computer.

- Confirm that the unit is properly connected to the computer through its USB port. The unit might not operate properly if connected through a USB hub.

- To show the unit's files on a computer, after connecting the unit to the computer using a USB cable, operation on the GENERAL SETTINGS screen is necessary. ("Accessing microSD cards from a computer" on page 50)

## The wrong language was set accidentally

- Slide the  $\phi$ /I/HOLD switch toward the  $\phi$ /I icon until the unit turns off. Then, while pressing the HOME [■] button, slide the  $\phi$ /I/HOLD switch toward the  $\phi$ /I icon again. The language selection menu will appear, and you will be able to select the language.

## Noise is occurring

- If this unit is near a mobile phone, TV, radio, power amplifier or other device with a large transformer, noise could occur with this unit or other devices nearby.

## The built-in speaker volume is low

- Turn the  $\Omega$ / $\square$  (headphone/speaker) volume in the direction that increases the number.
- If input levels were low during recording, it might be difficult to hear even when the speaker is at its maximum volume. If the maximum input level during recording is close to 0 dB, the built-in speaker will output at near maximum volume
- If more volume is needed, connect an external speaker with a built-in amp or an amp with a speaker connected to it.

## The date/time is incorrect

- They can be set again using the GENERAL SETTINGS screen > SYSTEM page > DATE/TIME item. ("Setting the date and time" on page 17)

## The MENU button is not working

- The MENU button cannot be used when the unit is recording, in recording standby, playing back or paused. Press the HOME [■] button to stop the unit.

## A file is not recognized

- Recognizing files correctly becomes impossible when the total number of files exceeds 5000.
- Subfolders below the third level cannot be shown.
- This unit cannot show files that are not in the SOUND folder. ("File and project structure overview" on page 43)
- Only files in MP3 and WAV formats, including BWF, will be shown.
- Files that are damaged cannot be shown correctly by this unit.

## A file cannot be divided

- File division is not possible if it would create a file with a name that is the same as an existing file.
- File division is not possible if the file name would become more than 200 characters long.
- Mark division is not possible if it would create a file that is less than four seconds long.
- Manual file division is not possible if it would create a file that is less than two seconds long.

## Batteries run out of power quickly

Try the following.

- Reduce the backlight time ("Power saving (energy conservation) mode" on page 56).
- Turn off all indicators ("Power saving (energy conservation) mode" on page 56).
- Reduce the brightness ("Power saving (energy conservation) mode" on page 56).

## 18 - Troubleshooting

- Reduce the contrast (“Power saving (energy conservation) mode” on page 56).
- Turn the recording pause function on (“Recording app overview” on page 26).
- Lower the headphone/speaker volume.
- Disconnect input and output devices that are not in use.

### The screen is dim

- Set BACKLIGHT to ALWAYS (“Power saving (energy conservation) mode” on page 56).

#### **NOTE**

The screen will always be dim when BACKLIGHT is set to OFF.

## 19-1 Specifications and rated values

### Recorder specifications

#### Recording media

microSD cards (64 MB – 2 GB)  
 microSDHC cards (4 GB – 32 GB)  
 microSDXC cards (48 GB – 512 GB)

#### Recording/playback formats

WAV (BWF): 44.1/48/96 kHz, 16/24-bit or 32-bit float  
 MP3: 44.1/48 kHz, 128/192/256/320 kbps

#### Number of channels

Input channels  
 4 channels maximum  
 Recording tracks  
 6 tracks maximum

### Analog audio input ratings

#### Mic inputs (balanced)

##### Input jacks 3/4 (when INPUT SELECT set to MIC)

Connectors:  
 XLR-3-31 equivalent (1: GND, 2: HOT, 3: COLD)  
 (supports phantom power only when MIC input selected)  
 Input impedance: 2.2 kΩ or higher  
 Maximum input level: +2 dBu  
 Minimum input level: -75 dBu

##### Input jacks 3/4 (when INPUT SELECT set to LINE)

Connectors:  
 XLR-3-31 equivalent (1: GND, 2: HOT, 3: COLD)  
 Input impedance: 9 kΩ or higher  
 Nominal input level: +4 dBu (GAIN setting at minimum)  
 Maximum input level: +24 dBu  
 Minimum input level: -53 dBu

#### Line input (unbalanced): MIC/EXT IN jack (can provide plug-in power)

Connector: 3.5mm (1/8") stereo mini jack  
 Input impedance: 10 kΩ or higher (when plug-in power is off)  
 1.8 kΩ or higher (when plug-in power is on)  
 Nominal input level: -20 dBV (GAIN setting at minimum)  
 Maximum input level: 0 dBV  
 Minimum input level: -67 dBV

### Analog audio output

#### Line output (unbalanced): LINE OUT jack

Connector: 3.5 mm (1/8") stereo mini jack  
 Output impedance: 210 Ω  
 Nominal output level: -14 dBV  
 Maximum output level: +6 dBV

- 0 dBu = 0.775 Vrms
- 0 dBV = 1 Vrms

#### Headphone output: headphone jack

Connector: 3.5 mm (1/8") stereo mini jack  
 Maximum output: 45 mW + 45 mW (THD+N 0.1% or less, into 32 Ω load)

#### Built-in speaker

0.4 W (mono)

### USB

Port: USB Type-C  
 Transfer mode: USB 2.0 Hi-Speed  
 Device classes: mass storage, USB audio 2.0 (USB class compliant)

### USB audio

Sampling frequencies  
 44.1, 48, 96 kHz  
 Quantization bit depth: 24-bit  
 Number of input channels: 6 (output from unit)  
 Number of output channels: 2 (input to unit)

### Bluetooth device connector

For Bluetooth adapter (AK-BT1) only

### Audio performance

#### Mic amp EIN (equivalent input noise)

-125 dBu or less

#### Frequency response

Input jacks 3/4 to PCM data  
 20 Hz – 20 kHz at 48 kHz: +0/-0.3 dB (JEITA)  
 20 Hz – 40 kHz at 96 kHz: +0/-0.7 dB (JEITA)

#### Dynamic range

Input jacks 3/4 to PCM data (20 kHz SPCL LPF, A-weighting)  
 112 dB or higher (at 48 kHz)  
 112 dB or higher (at 96 kHz)

#### Total harmonic distortion ratio (THD+N)

Input jacks 3/4 (LINE IN) to PCM data, 1 kHz sine wave, -5 dBFS input, GAIN at minimum, 20 kHz SPCL LPF  
 0.008% or less  
 Input jacks 3/4 (MIC IN) to PCM data, 1kHz sine wave, -5 dBFS input, GAIN at minimum, 20 kHz SPCL LPF  
 0.006% or less

Note: JEITA indicates conformance to JEITA CP-2150

### Recording times (in hours: minutes)

File format (recording setting)		Card capacity	
		32 GB (microSDHC)	128 GB (microSDXC)
320 kbps MP3 (stereo)	44.1 kHz	222:13	888:53
16-bit WAV (stereo)		50:23	201:33
24-bit WAV (stereo)	96 kHz	15:25	61:43
32-bit float WAV (stereo)	96 kHz	11:34	46:16

- The recording times shown above are estimates. They might differ depending on the microSD card in use.
- The recording times shown above are not continuous recording times, but rather they are the total possible recording times for the microSD card.
- If recorded in mono, maximum recording times will be about double those above.
- If using dual recording, maximum recording times will be shorter than those above.

# 19 - Specifications

## Operating system and other requirements

Check the TEAC Global Site for the latest information about supported operating systems.

<https://teac-global.com/>

### CAUTION

Operation with each OS was confirmed with standard system setups that met the following conditions.  
Operation is not guaranteed, however, with all systems that meet the following conditions.

### Portacapture X6

#### Windows

Supported operating systems

- Windows 11
- Windows 10 64-Bit

Computer hardware requirements

Windows computer with a USB 2.0 (or higher)

- Operation is not guaranteed using the TASCAM driver with ARM64 CPUs.

#### Mac

Supported operating systems

- macOS Sonoma (14)
- macOS Ventura (13)
- macOS Monterey (12)

Computer hardware requirements

Mac with a USB 2.0 (or higher)

#### iOS/iPadOS devices

Supported operating systems

- iOS 17/iPadOS 17
- iOS 16/iPadOS 16
- iOS 15/iPadOS 15

### Portacapture Control

#### iOS/iPadOS devices

Supported operating systems

- iOS 17/iPadOS 17
- iOS 16/iPadOS 16
- iOS 15/iPadOS 15

#### Android devices

Supported operating systems

- Android 11
- Android 10

- Compatibility has been confirmed, but this does not guarantee operation with all devices.

## Other

### Power

- 4 AA batteries (alkaline, NiMH or lithium)
- USB bus power from a computer
- TASCAM PS-P520U AC adapter (sold separately)

### Power consumption

7.5 W (maximum)

### Battery operation time (continuous operation)

- Using alkaline batteries (EVOLTA)

Use conditions	Operation time
Input through inputs 1-2 (built-in mics) Phantom power not used 44.1 kHz stereo WAV (BWF) 24-bit recording	About 13.5 hours
Input through inputs 1-2 (built-in mics) and input jacks 3-4 (using phantom power: +48 V, 3 mA×2 load) 44.1 kHz stereo WAV (BWF) 24-bit recording	About 5.5 hours

- Using NiMH battery (eneloop)

Use conditions	Operation time
Input through inputs 1-2 (built-in mics) Phantom power not used 44.1 kHz stereo WAV (BWF) 24-bit recording	About 11 hours
Input through inputs 1-2 (built-in mics) and input jacks 3-4 (using phantom power: +48 V, 3 mA×2 load) 44.1 kHz stereo WAV (BWF) 24-bit recording	About 5.5 hours

- Using lithium batteries (Energizer Ultimate Lithium)

Use conditions	Operation time
Input through inputs 1-2 (built-in mics) Phantom power not used 44.1 kHz stereo WAV (BWF) 24-bit recording	About 22 hours
Input through inputs 1-2 (built-in mics) and input jacks 3-4 (using phantom power: +48 V, 3 mA×2 load) 44.1 kHz stereo WAV (BWF) 24-bit recording	About 11.5 hours

### NOTE

When using phantom power, the operation time might be reduced depending on the mics being used.

### Dimensions

75 × 174.3 × 37.2 mm (width × height × depth, excluding protrusions)

### Weight

365/265 g (with/without batteries)

### Operating temperature range

0–40°C

- Illustrations in this manual might differ in part from the actual product.
- Specifications and external appearance might be changed without notification to improve the product.

19-2 Dimensional drawings

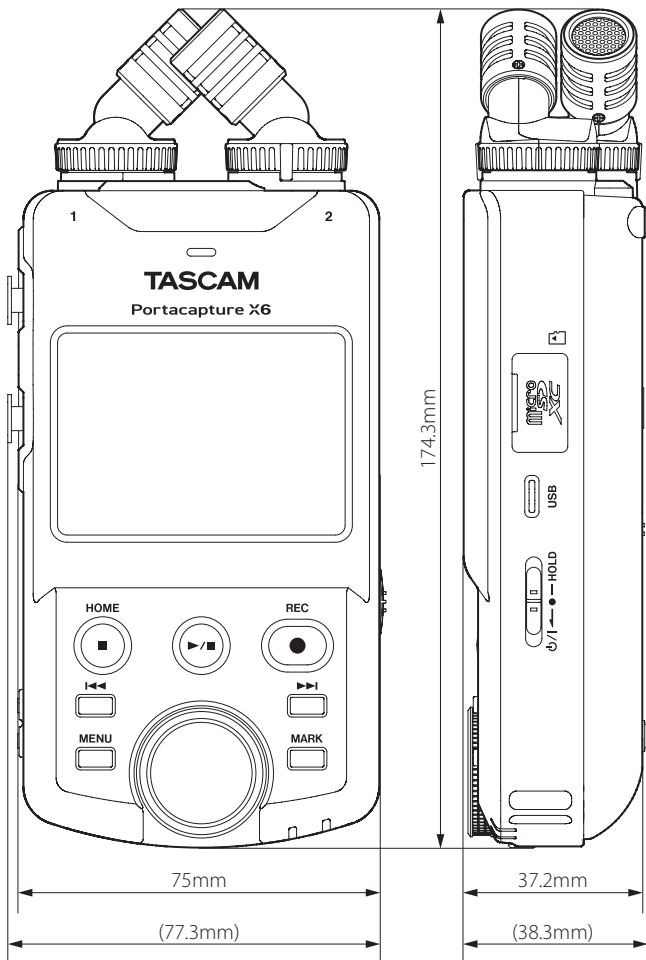

19-3 Block diagram

Portacapture X6  
MIXER BLOCK DIAGRAM

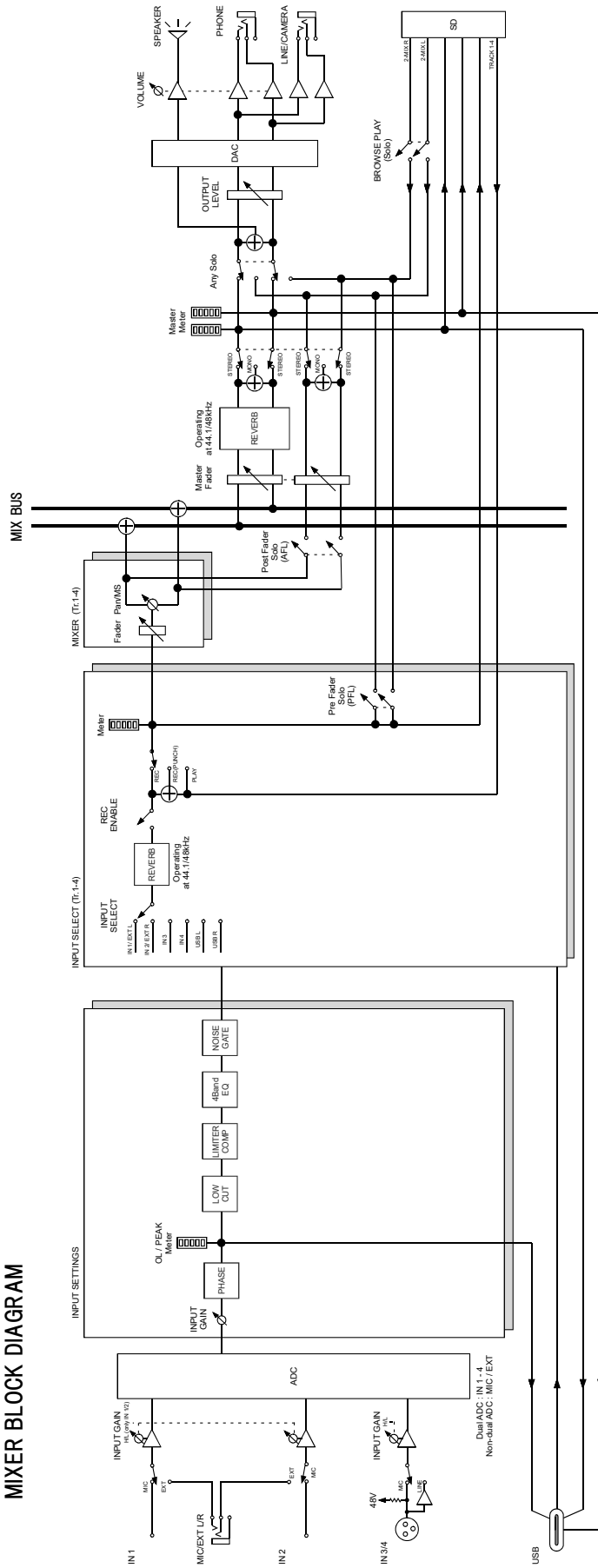

# TASCAM

## TEAC CORPORATION

<https://tascam.jp/jp/>

Phone: +81-42-356-9143  
1-47 Ochiai, Tama-shi, Tokyo 206-8530 Japan

---

## TEAC AMERICA, INC.

<https://tascam.com/us/>

Phone: +1-323-726-0303  
10410 Pioneer Blvd., Unit #3, Santa Fe Springs, CA 90670, U.S.A

---

## TEAC UK Ltd.

<https://www.tascam.eu/en/>

Phone: +44-1923-797205  
Luminous House, 300 South Row, Milton Keynes, Buckinghamshire, MK9 2FR, United Kingdom

---

## TEAC EUROPE GmbH

<https://www.tascam.eu/de/>

Phone: +49-611-71580  
Bahnstrasse 12, 65205 Wiesbaden-Erbenheim, Germany

---

## TEAC SALES & TRADING(SHENZHEN) CO., LTD

<https://tascam.cn/cn>

Phone: +86-755-88311561-2  
Room 817, Xinian Center A, Tairan Nine Road West, Shennan Road, Futian District, Shenzhen, Guangdong Province 518040, China

---

0624.MA-3542E