



P60DT-BL / P60DT-W
Instruction manual

P60DT-BL / P60DT-W



Important safety instructions

Always follow these precautions listed below to avoid the possibility of serious injury or even death from electrical shock, short-circuiting, damages; fire or other hazards.

These precautions include, but are not limited to, the following:

- Read these instructions.
- Keep these instructions.
- Heed all warnings.
- Follow all instructions, particularly those pertaining to rigging, mounting, hanging and electrical connections.
- This professional device needs to be installed by qualified personnel only. As improper installation may cause the unit to fall, resulting in personal injury and/or property damage.
- Take care of the loudspeaker wires; they should be free of damage. Damaged loudspeaker wires may result in poor sound quality, in damaged amplifiers, injury and/or electrical shock.
- No mains power shall be connected to the loudspeaker, doing so will damage the loudspeaker, and increase the risk of fire.
- Respect power rating, to prevent damaged loudspeakers, and risk of fire.
- Do not open the loudspeaker or attempt to disassemble the internal parts or modify them in any way. If the loudspeaker appears to be malfunctioning (no sound or distorted sound), if you detect smoke or a strange smell coming from the unit, discontinue use immediately and have it inspected by qualified

personnel.

- Use cables of the right gauge, especially for long runs or high power systems.
- Use cables with clear color indication and maintain polarity throughout the whole system.
- Avoid loud feedback from microphones; this can damage your loudspeaker.
- Clean only with dry cloth.
- Avoid touching the unit's sharp metal edge to prevent injury.
- Do not block any ventilation openings. Install in accordance with the manufacturer's instructions.
- Only use attachments/accessories that are specified and approved by the manufacturer.
- Install the loudspeaker in a location that can structurally support the weight of the unit and its mounting hardware.
- Tighten all loudspeaker clamps securely. Doing otherwise may result in the unit falling down and causing personal injury and/or property damage.
- Securely attach both the primary and secondary hanging cables. Please, be guided by applicable building codes here. Doing otherwise may result in the unit falling down and causing personal injury and/or property damage.
- Use only industry-accepted mounting tools and methods.
- Exposure to loud audio levels over a long time can cause severe hearing loss.

- Do not forget to consult the local law directions regarding producing sound in public places.
- Please check the unit's condition after unpacking. If the outside or the carton box has been damaged, inform your shipper immediately.
- Do not expose the device to water, damp or wet conditions.
- The unit is designed for fixed installations in buildings. It is not fit for use in mobile applications.
- Refer all servicing to qualified personnel.
- Indoor use only.

The warranty of this product and the applicable terms and conditions are provided by the dealer where you purchased this product.

Consignes de sécurité importantes

Respectez à tout moment les consignes énumérées ci-dessous afin d'éviter de sérieuses lésions ou même le décès suite à un choc électrique, à un court-circuit, à des dégâts, à un incendie ou à d'autres dangers.

Ces consignes comprennent, sans y être limitées, les suivantes :

- Lisez les présentes consignes.
- Conservez ces consignes.
- Tenez compte de tous les avertissements.
- Respectez toutes les consignes, en particulier celles qui ont trait au gréement, au montage, à la suspension et aux connexions électriques.
- Ce matériel professionnel doit être installé par du personnel qualifié uniquement, étant donné qu'une installation défectueuse peut résulter dans la chute de l'objet, ce qui peut causer des lésions corporelles et/ou des dégâts matériels.
- Prenez soin des câbles du haut-parleur, ils ne peuvent aucunement être endommagés. Les câbles de haut-parleurs endommagés peuvent donner lieu à une mauvaise qualité sonore, à des dégâts aux amplificateurs, à des lésions et/ou à des chocs électriques.
- Il ne faut pas connecter les haut-parleurs au réseau électrique, cela peut endommager le haut-parleur et augmenter le risque d'incendie.
- Respectez la puissance nominale afin d'éviter les dégâts aux haut-parleurs ainsi que les risques d'incendie.

- N'ouvrez pas le haut-parleur et n'essayez pas de démonter les pièces internes ni de les modifier de quelque façon que ce soit. Au cas où le haut-parleur semble mal fonctionner (aucun son ou son altéré), si vous constatez de la fumée ou une odeur inhabituelle émanant de l'appareil, cessez immédiatement de l'utiliser et faites-le inspecter par du personnel qualifié.
- Utilisez des câbles du calibre adéquat, en particulier pour de longues distances ou pour des systèmes de haute puissance.
- Utilisez des câbles avec une indication de couleur claire et gardez la polarité à travers tout le système.
- Évitez un accrochage acoustique trop fort des microphones, ceci peut endommager votre haut-parleur.
- Nettoyez uniquement au moyen d'un chiffon sec.
- Évitez de toucher le bord tranchant en métal de l'appareil pour éviter les blessures.
- Ne bloquez aucune ouverture d'aération. Installez selon les instructions du fabricant.
- Utilisez uniquement des pièces jointes/des accessoires spécifiés et approuvés par le fabricant.
- Installez le haut-parleur à un endroit qui peut supporter de façon structurelle le poids de l'appareil et de son équipement de montage.
- Serrez fermement toutes les pinces du haut-parleur. Y manquer pourrait mener à la chute de l'appareil et causer ainsi des lésions aux personnes et/ou des dégâts matériels.
- Fixez solidement les câbles de suspension principal et secondaire. Veillez à respecter dans cette optique les codes

de construction qui sont d'application. Dans le cas contraire, l'appareil pourrait tomber, ce qui peut causer des lésions aux personnes ou même entraîner la mort.

- Utilisez uniquement des outils et méthodes de montage reconnus dans le secteur.
- L'exposition à de hauts niveaux sonores pendant une longue période peut causer de sérieuses pertes auditives.
- N'oubliez pas de consulter les directives légales locales en matière de production de son dans des lieux publics.
- Veuillez vérifier l'état de l'appareil après l'avoir déballé. Si l'extérieur ou la boîte en carton a été endommagé, avertissez-en immédiatement le transporteur.
- N'exposez l'appareil ni à l'eau, ni à l'humidité, ni à des conditions humides.
- L'appareil est destiné à des installations fixes dans les bâtiments. Il ne convient pas à l'usage mobile.
- Confiez tout l'entretien et toutes les réparations à du personnel qualifié.
- Utilisation à l'intérieur uniquement.

La garantie de ce produit et les conditions applicables sont fournies par le partenaire chez qui vous avez acheté ce produit.

Introduction

The Apart P60DT 6.5" two-way, pendant loudspeaker brings an exceptional dispersion to areas and rooms with high-ceilings or large open spaces, while offering a clear speech and musical purity. Available in black (P60DT-BL) or white (P60DT-W), Apart P60DT is suitable for a wide range of background and foreground sound applications.

The dual Gripple™ wire suspension system, euroblock in/out connector, loudspeaker cables and 70/100 volt power rotary with 16 ohms connectivity can be hidden after installation by the innovatively designed end-cap. The attractive aesthetics and ease-of-installation make this product an industry standard.

Features

- High performance, attractive aesthetics, and ease of installation, for applications where loudspeakers are required to be suspended below the ceiling.
- Installer-friendly end cap with cut-out slot and integrated magnetic fixing, hides the power selector and all cable connections, and can be installed after the loudspeaker is hung.
- Two Gripple™ wire suspension cables are provided for a safe and secure, fast and simple installation.
- Handy euroblock connector with permanent pass-through allows for a quick install and easy daisy chaining of multiple loudspeakers.
- The 70/100 volt power tapping can be selected using the

rotary on the top of the loudspeaker and also offers 16 ohms connectivity.

- Tuned bass reflex port for optimised low frequency performance
- High intelligibility while remaining perfect music reproduction quality
- 6.5" LF driver for, with 1" tweeter
- 120 W dynamic power handling
- Loudspeaker overload protection for a 24/7 failsafe operation
- Available in black or white

Supplied items

Unpack the contents and confirm following items are included.

- Loudspeaker x 1
- End cap with integrated cable cover x 1
- Gripper snaphook cable 5m x 2
- Gripper express locking device x 2
- Important safety instructions x 1

Loudspeaker cables are not included.

Installation instructions

ATTENTION

Apart Audio nv is not responsible for damages resulting from the negligent installation of any loudspeaker.

WARNING

Please make sure that the mounting structure is capable of safely supporting the loudspeaker's weight.

- 1 As shown, thread the snaphook cable through the opening in the locking device nearest the release button, and in the direction of the arrow shown on the unit.

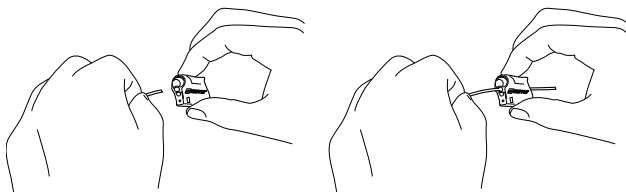

- 2 Loop the snaphook cable over or through a secure structure, and pass the cable back through the locking device, using the opening closest to the remaining release button.

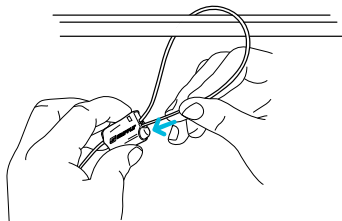

- 3 Repeat steps 1 and 2 for both the primary and secondary suspension cables.

4

As shown, connect the snaphook on the primary cable through the central mounting point on the loudspeaker



5

As shown, connect the snaphook on the secondary safety cable through one of the remaining mounting points.



6

Adjust the length of the primary cable so that the loudspeaker hangs at the desired height (1). Adjust the length of the secondary safety cable, allowing some slack so that the loudspeaker hangs straight (2).

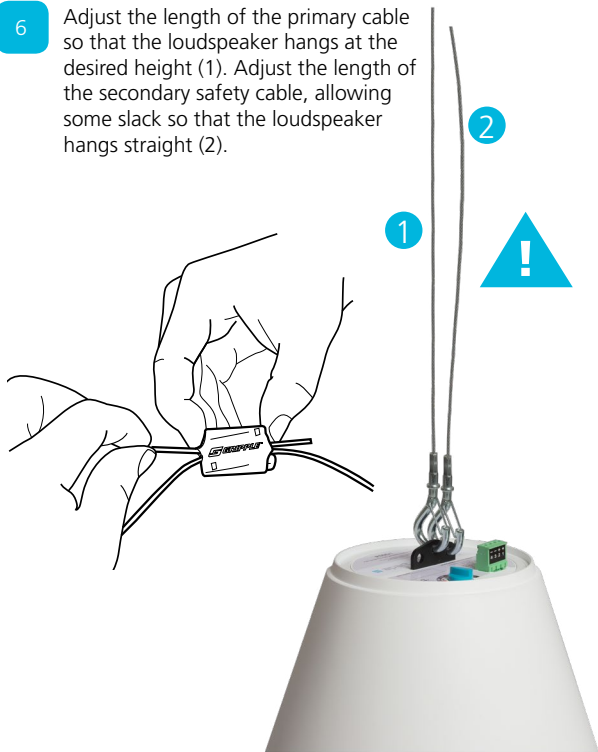

The length of the cable can be adjusted and/or released by pressing the buttons shown. When adjusting the length, always leave a minimum of 75mm of cable protruding from the locking device.

7

As shown, attach the loudspeaker cables according to whether you are connecting a single loudspeaker or daisy chaining more than one.

The euroblock connector should then be pressed firmly onto the corresponding male euroblock connector on the top of the loudspeaker.

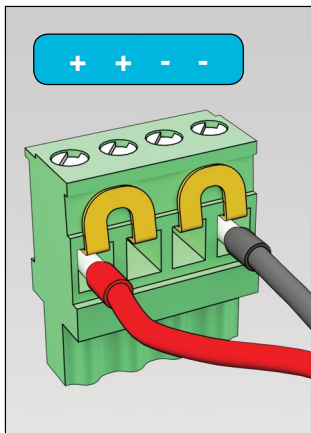

wiring: single cable

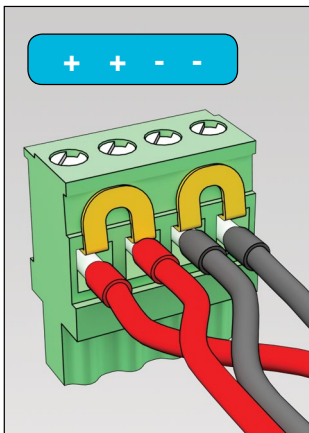

wiring: daisy-chained to next unit



The use of wire ferrules is strongly recommended when stranded wire is used.

8

As shown, select the appropriate power tap setting on the top surface of the loudspeaker

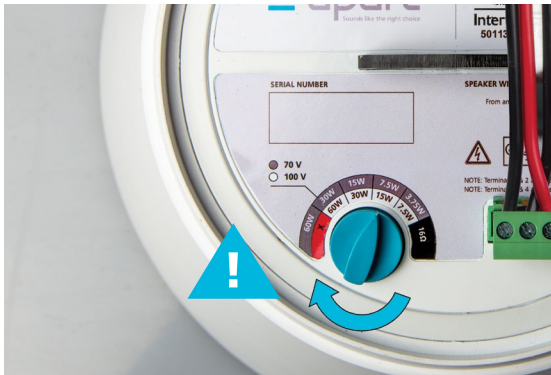

WARNING

Set the power tapping prior to applying audio and only change the setting while the audio amplifier is shut off.

WARNING

The 16 ohm setting is not compatible with 70 volt or 100 volt line amplifiers!

WARNING

The highest 70 volt power setting is not compatible with 100 volt line amplifiers, only with 70 volt line amplifiers.

9

Attach the end cap by placing this around the suspension and loudspeaker cables, ensuring this is held firmly in place by the magnetic fixings (1). Finally clip the cable cover in place (2).



Dimensions in mm

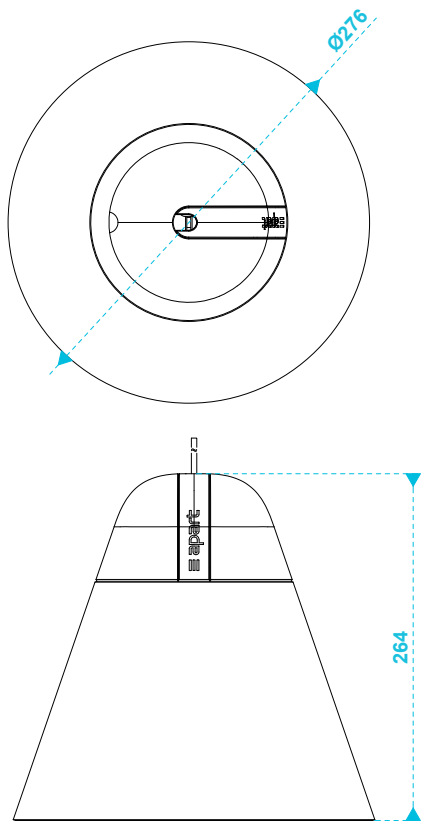

developed
by
Apart Audio nv
Industriepark Brechtsebaan 8 bus 1
2900 Schoten - Belgium

Company names, product names and trademarks are property of their respective owners.

Apart Audio specifications are subject to change without notice.

