

DATA SHEET

Community L SERIES Beamforming Venue Horn™



LVH-909/AP

90° HORIZONTAL DISPERSION,
ACTIVE PLUS, 20°, 80°, 100° VERTICAL DISPERSION,
ARRAYABLE, HIGH OUTPUT LOUDSPEAKER

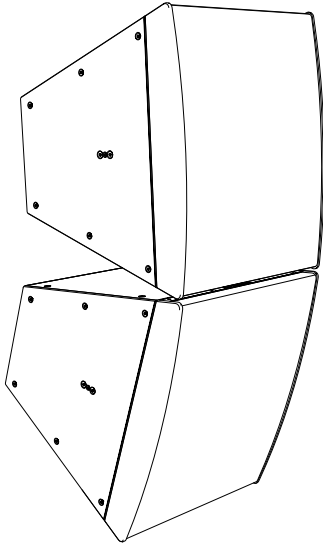

FEATURES

- Designed with individual driver control for extraordinary performance in large venues
- Large format, horn-loaded triaxial array maintains pattern control to 200 Hz
- Maximize long-throw SPL level or extend vertical coverage pattern
- Colinear manifold for HF and MF beamforming
- Indoor or Outdoor weather-resistant models
- EN54-24 and ISO 7240-24 certification

TECHNICAL SPECIFICATIONS¹

Operating Mode	Multi-Amplifier with FIR DSP Beamforming		
Operating Environment	Indoor or Outdoor Direct Exposure		
Operating Range (-10dB) ²	48 Hz to 20 kHz		
Nominal Beamwidth	Horizontal: 90° Vertical: 100°, 80°, 20° Symmetrical (user selectable presets)		
Transducers	LF: 4 x 12" (300 mm) with 3" (75 mm) CCAW voice coil, inherently weather-resistant cone in cast aluminum chassis MF: 3 x M200, 2" (51 mm) exit, ketone polymer diaphragm, compression driver HF: 4 x 1.5" (38 mm) CCAW voice coil, 1" (25 mm) exit, ketone polymer diaphragm, compact neodymium compression driver		
Nominal Continuous Power Handling ³	LF1, LF2, LF3, LF4 (each) MF 1, MF2, MF3 (each) HF 1, HF2, HF3, HF4 (each)	87 V (950 W, 8 Ω) 26 V (130 W, 5 Ω) 23 V, (65 W, 8 Ω)	
Nominal Maximum SPL (Processed) ⁴	20° pattern	139dB continuous	145dB peak
	80° pattern	134dB continuous	140dB peak
	100° pattern	134dB continuous	140dB peak
Rated Continuous Voltage ⁵	LF	50.1 V (34 dBV)	
	MF	20.0 V (26 dBV)	
	HF	15.8 V (24 dBV)	
Rated Maximum SPL (Processed) ⁶	20° pattern	136dB continuous	148dB peak
	80° pattern	132dB continuous	144dB peak
	100° pattern	131dB continuous	143dB peak
Recommended Amplifiers	LF: 4 Channels (2) ALC-1604D (Bridge Mode) MF & HF: 7 Channels (2) ALC-404D		
Crossover Frequencies	530 Hz, 1.84kHz		

APPLICATIONS

Stadiums · Houses of Worship · Arenas
Theaters · Ice Rinks · Auditoriums
Large Multipurpose Outdoor and Indoor Venues

DESCRIPTION

Biamp's Community L SERIES LVH-900/AP Beamforming Venue Horn, combined with the Community Amplified Loudspeaker Controllers (ALCs), precisely tailors the directivity of each loudspeaker, or array of loudspeakers, to meet the sound requirements in any application.

Designed for exceptional performance in large venues, each 90° Active Plus array consists of two LVH-909/AP loudspeakers with a total of eight 12-inch LF drivers, six Community M200 midrange compression drivers and eight 1.5-inch HF compression drivers.

Using patent pending techniques, the triaxial drivers in each cabinet are integrated to create half of the desired vertical coverage pattern. Using advanced FIR techniques, the output from the two loudspeakers are seamlessly integrated into one coherent wavefront filling the entire 72 x 31-inch face of the array, providing pattern control to below 200 Hz. An LVH-909/AP array offers 90 degrees of fixed horizontal dispersion, three presets for vertical dispersion beamforming and has specialized input panels for dual cabinet long-throw configurations. The LVH-900 Active-Plus (AP) models allow DSP settings and control of individual drivers to provide uniform sound to the audience areas.

Typical applications include music and speech reinforcement for large houses of worship, stadiums, theatres, and much more. Possessing advanced features, highly-focused dispersion patterns, weather-resistant construction, and most importantly sonic excellence, LVH-900 loudspeakers make installations not only fast and simple, but as functionally effective as possible.

PHYSICAL

Input Connection	Lever-actuated wire clamping 4, 6 and 8-position terminal blocks
Mounting Points	(24) M10 rigging inserts per cabinet
Operation Environment	Indoor and Outdoor Outdoor: IP56 per IEC 60529 when used with the input panel and seal cup cover plates; Weather resistant to IEC 60068-2-1 Cold, IEC 60068-2-2 Dry Heat, IEC 60068-2-6 Vibration, IEC 60068-2-30 Damp Heat, cyclic, IEC 60068-2-42 SO2, and IEC 60068-2-78 Damp Heat, steady state
Dimensions H x W x D	948 mm x 797 mm x 775 mm (37.3" x 31.4" x 30.5")
Weight	113.4 kg (250 lbs) Indoor model 95.3 kg (210 lbs) Outdoor weather-resistant model
Finish	Refer to the Technical Drawing (page 5)

OPTIONS

Accessories (full list on page 6)	Splay Bracket: LVH-900SP1 Type 1; LVH-900SP2 Type 2 Indoor Frames: LVH-900AF Array frame; LVH-900PB Pull-back 3rd party rigging: Indoor & outdoor
-----------------------------------	--



Community L SERIES Beamforming Venue Horn

LVH-909/AP

90° HORIZONTAL DISPERSION,
ACTIVE PLUS, 20°, 80°, 100° VERTICAL DISPERSION,
ARRAYABLE, HIGH OUTPUT LOUDSPEAKER

20° DUAL-CAB PATTERN

AXIAL PROCESSED SENSITIVITY (dB SPL)⁷

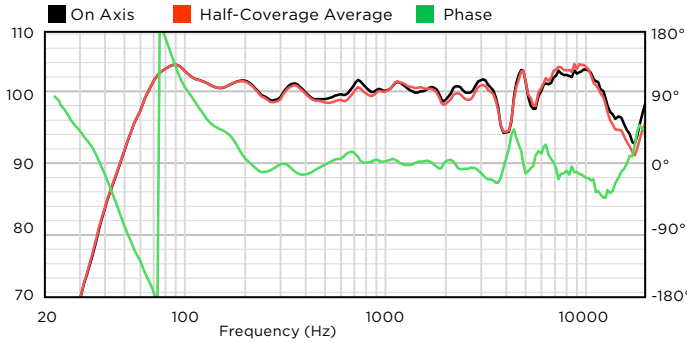

HORIZONTAL OFF-AXIS RESPONSE (dB SPL)⁸

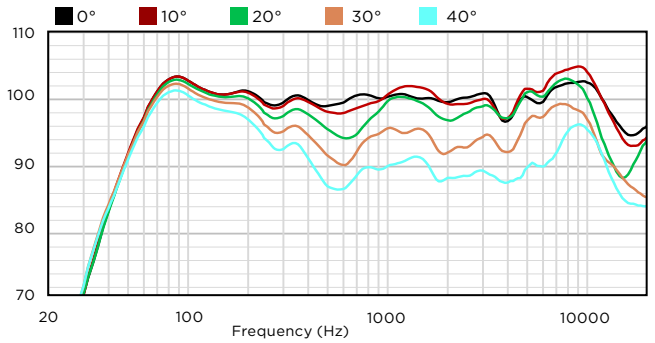

IMPEDANCE (Ω)

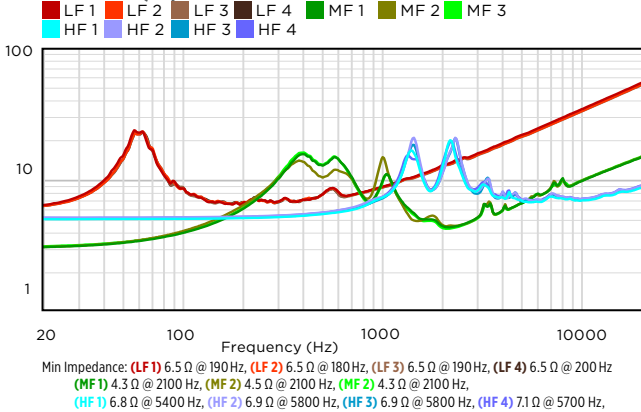

VERTICAL OFF-AXIS RESPONSE (dB SPL)⁸

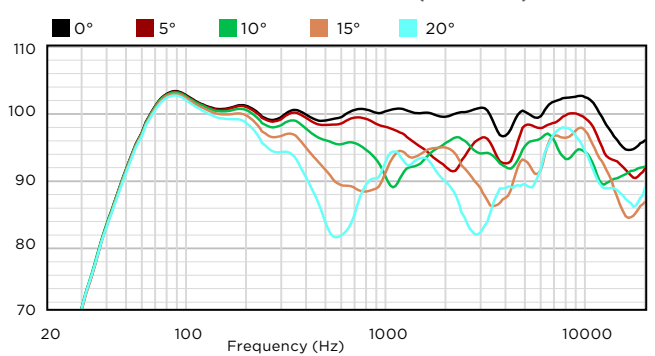

DIRECTIVITY INDEX (dB)⁹

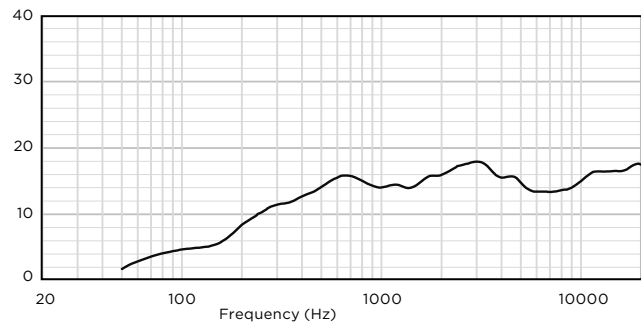

SPECIFICATIONS FOR EN54-24 (LVH-909/AP-20°)

Sensitivity (1 W, 4 m)	89 dB*	
Maximum SPL (4 m)	122 dB*	
Coverage (-6 dB) Horiz/Vert	500 Hz: 80°/30° * 1 kHz: 90°/15° *	2 kHz: 85°/10° * 4 kHz: 100°/20° *
Rated Impedance	4x HF: 8 Ω*; 3x MF: 5 Ω*; 4x LF: 8 Ω* (each)	

*not independently verified

BEAMWIDTH (degrees)¹⁰

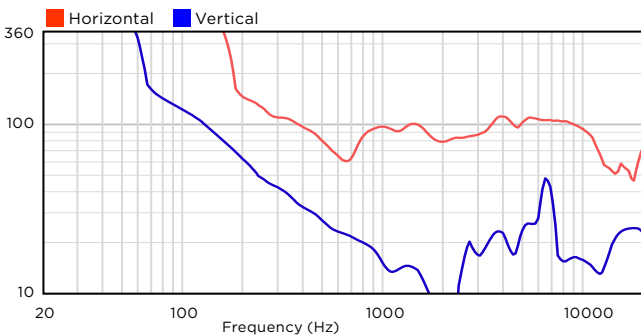

Community L SERIES Beamforming Venue Horn

LVH-909/AP

90° HORIZONTAL DISPERSION,
ACTIVE PLUS, 20°, 80°, 100° VERTICAL DISPERSION,
ARRAYABLE, HIGH OUTPUT LOUDSPEAKER

80° DUAL-CAB PATTERN

AXIAL PROCESSED SENSITIVITY (dB SPL)⁷

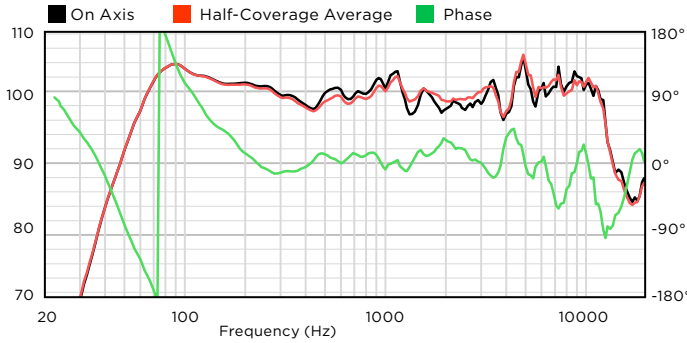

HORIZONTAL OFF-AXIS RESPONSE (dB SPL)⁸

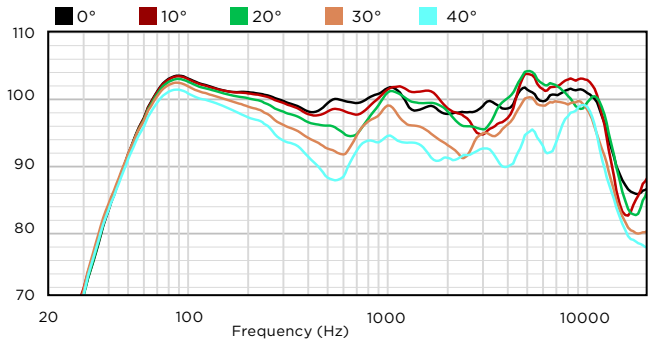

IMPEDANCE (Ω)

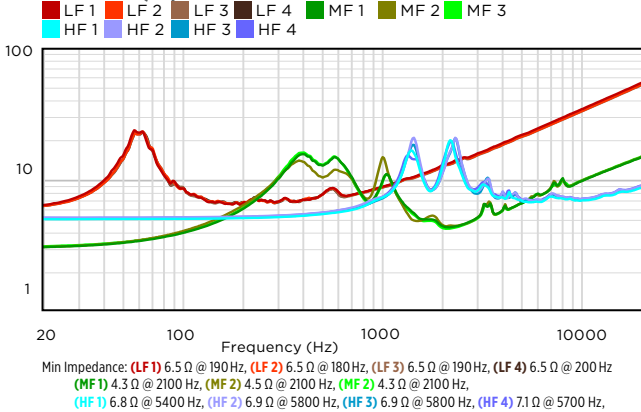

VERTICAL OFF-AXIS RESPONSE (dB SPL)⁸

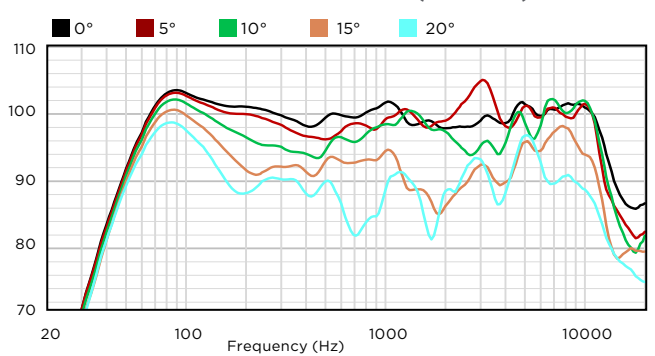

DIRECTIVITY INDEX (dB)⁹

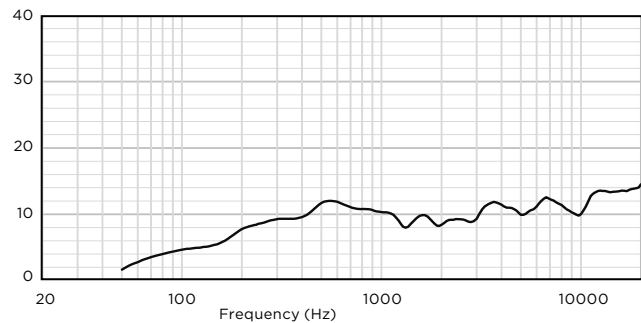

SPECIFICATIONS FOR EN54-24 (LVH-909/AP-80°)

Sensitivity (1 W, 4 m)	89 dB*	
Maximum SPL (4 m)	118 dB*	
Coverage (-6 dB) Horiz/Vert	500 Hz: 95°/80° * 1 kHz: 115°/85° *	2 kHz: 105°/75° * 4 kHz: 105°/75° *
Rated Impedance	4x HF: 8 Ω*; 3x MF: 5 Ω*; 4x LF: 8 Ω* (each)	

*not independently verified

BEAMWIDTH (degrees)¹⁰

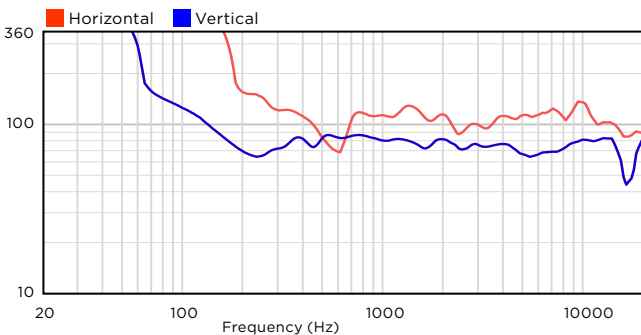

Community L SERIES Beamforming Venue Horn

LVH-909/AP

90° HORIZONTAL DISPERSION, 100° DUAL-CAB PATTERN
 ACTIVE PLUS, 20°, 80°, 100° VERTICAL DISPERSION,
 ARRAYABLE, HIGH OUTPUT LOUDSPEAKER

AXIAL PROCESSED SENSITIVITY (dB SPL)⁷

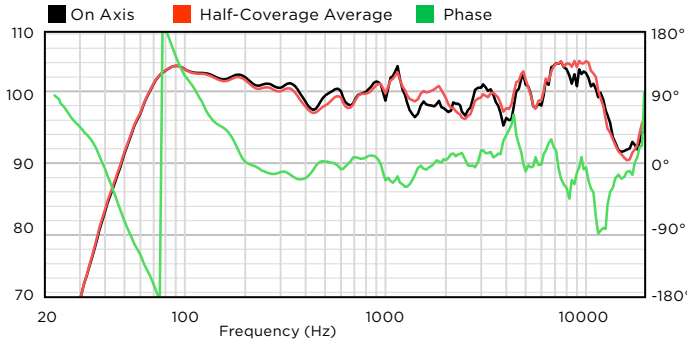

HORIZONTAL OFF-AXIS RESPONSE (dB SPL)⁸

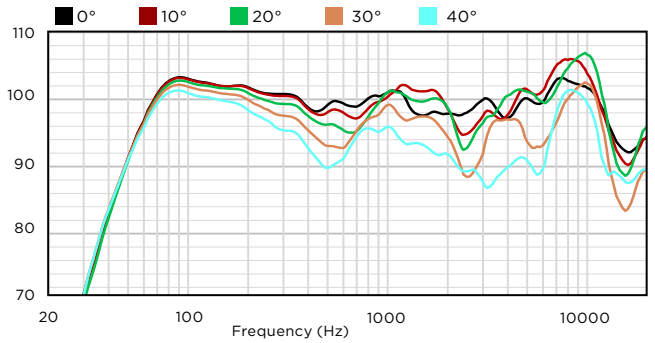

IMPEDANCE (Ω)

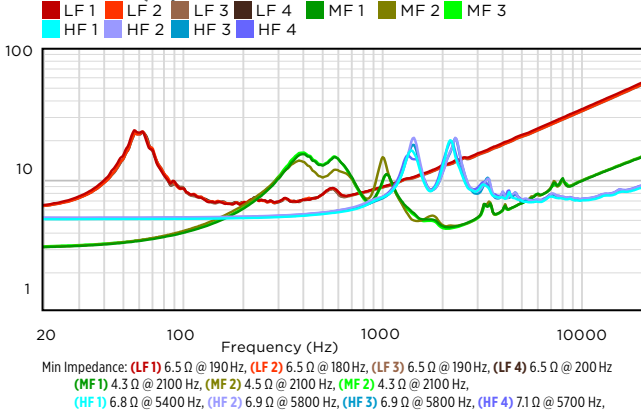

VERTICAL OFF-AXIS RESPONSE (dB SPL)⁸

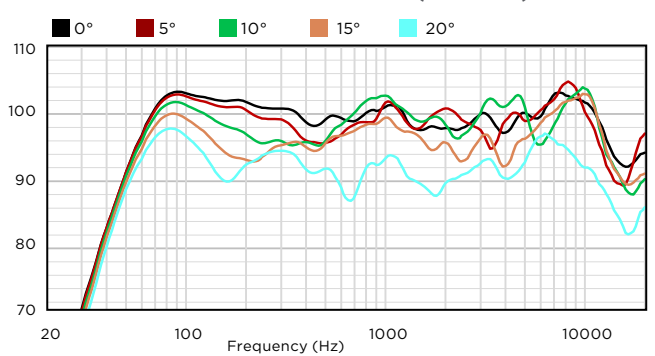

DIRECTIVITY INDEX (dB)⁹

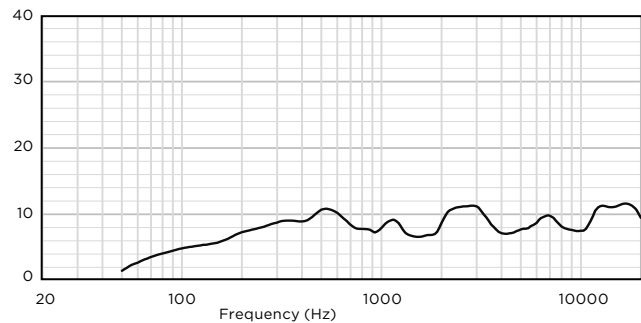

SPECIFICATIONS FOR EN54-24 (LVH-909/AP-100°)

Sensitivity (1 W, 4 m)	89 dB*	
Maximum SPL (4 m)	117 dB*	
Coverage (-6 dB) Horiz/Vert	500 Hz: 105°/110° * 1 kHz: 130°/105° *	2 kHz: 105°/100° * 4 kHz: 95°/110° *
Rated Impedance	4x HF: 8 Ω*; 3x MF: 5 Ω*; 4x LF: 8 Ω* (each)	

*not independently verified

BEAMWIDTH (degrees)¹⁰

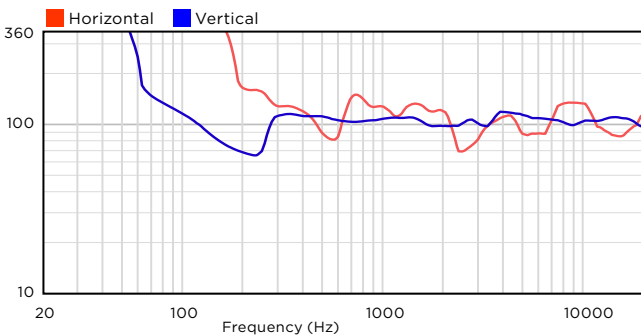

Biamp strives to improve its products on a continual basis. Specifications are therefore subject to change without notice.

Community L SERIES Beamforming Venue Horn

LVH-909/AP

90° HORIZONTAL DISPERSION,
ACTIVE PLUS, 20°, 80°, 100° VERTICAL DISPERSION,
ARRAYABLE, HIGH OUTPUT LOUDSPEAKER

TECHNICAL DRAWING / DIMENSIONS / FINISH

H x W x D

37.3" x 31.4" x 30.5"
(948 x 797 x 775 mm)

Unit Weight

250 lbs (113.4 kg) (Indoor)
210 lbs (95.3 kg) (Outdoor Weather-resistant)

Shipping Weight (on a pallet)

307 lbs (139.3 kg) (Indoor)
267 lbs (121 kg) (Outdoor Weather-resistant)

Enclosure Finish

Indoor: Powder-coated perforated steel (indoor) grille backed with acoustically transparent woven fabric and coated with Biamp's robust PolyCoat finish on 15mm Baltic Birch plywood enclosure

Outdoor (WR): Powder-coated marine grade aluminum grille featuring hydrophobically-treated acoustically transparent woven black fabric backing on a 15mm PolyGlas™ enclosure coated with Biamp's durable PolyCoat finish, rated for both indoor and outdoor use

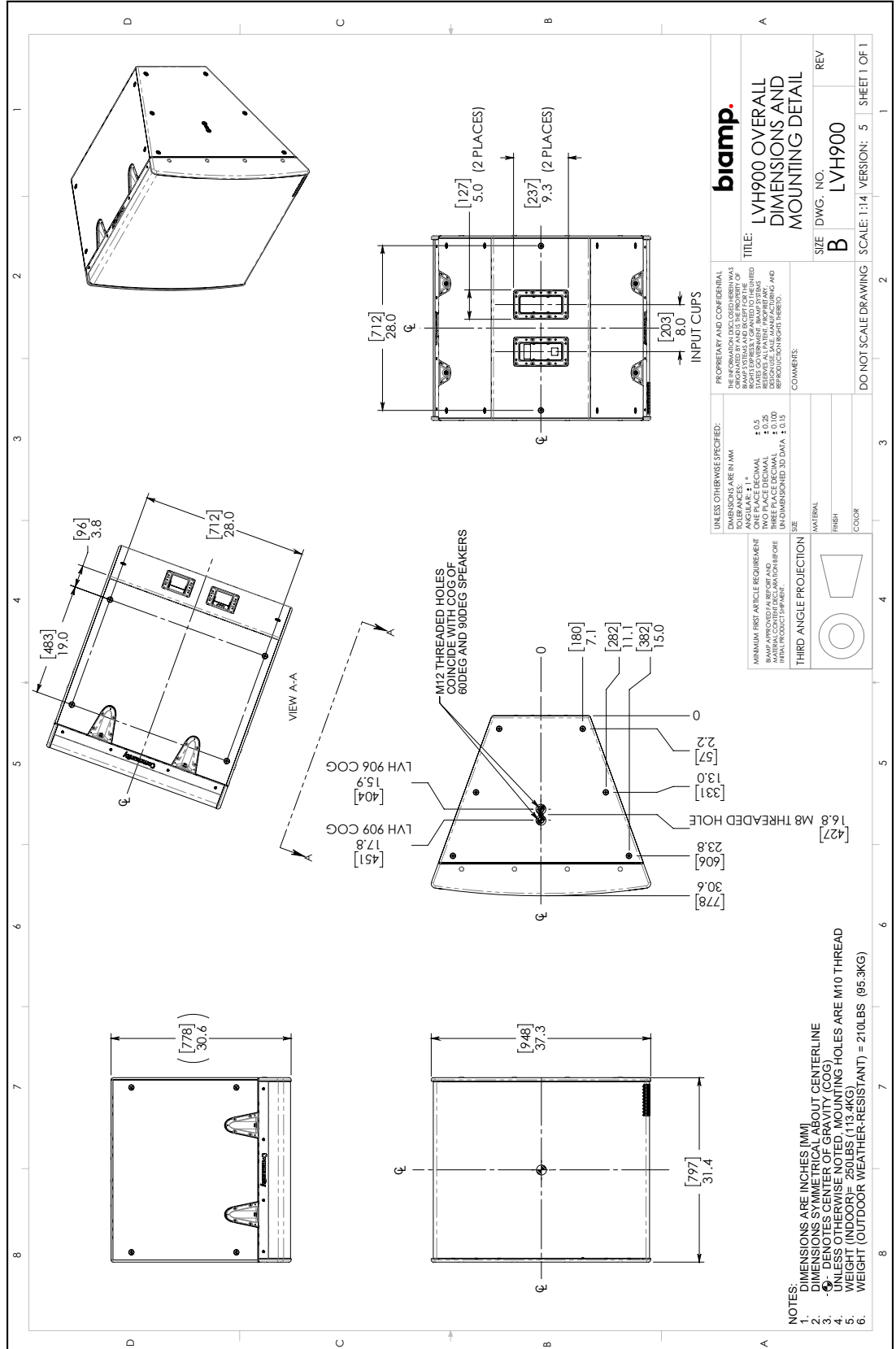

*Note: Outdoor (WR) versions - There are covers on the seal cups (4) and input panels (2)

Community L SERIES Beamforming Venue Horn

LVH-909/AP

90° HORIZONTAL DISPERSION,
ACTIVE PLUS, 20°, 80°, 100° VERTICAL DISPERSION,
ARRAYABLE, HIGH OUTPUT LOUDSPEAKER

SPLAY BRACKETS / DUAL CABINET CONFIGURATIONS

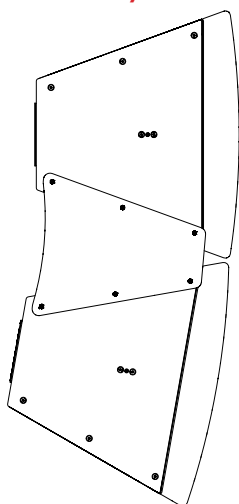

Achieves the 20° pattern

Type 2 Splay Bracket

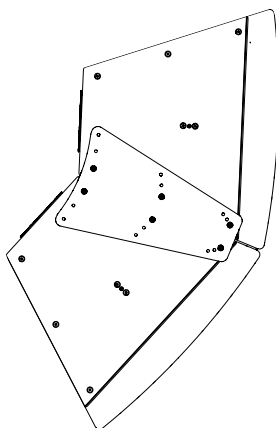

Achieves the 80° pattern

Type 1 Splay Bracket

0° hole set - Back Splay

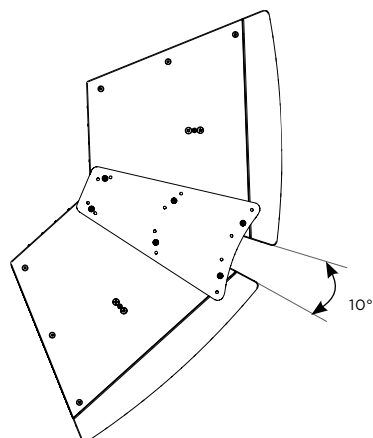

Achieves the 100° pattern

Type 1 Splay Bracket

10° hole set - Front Splay

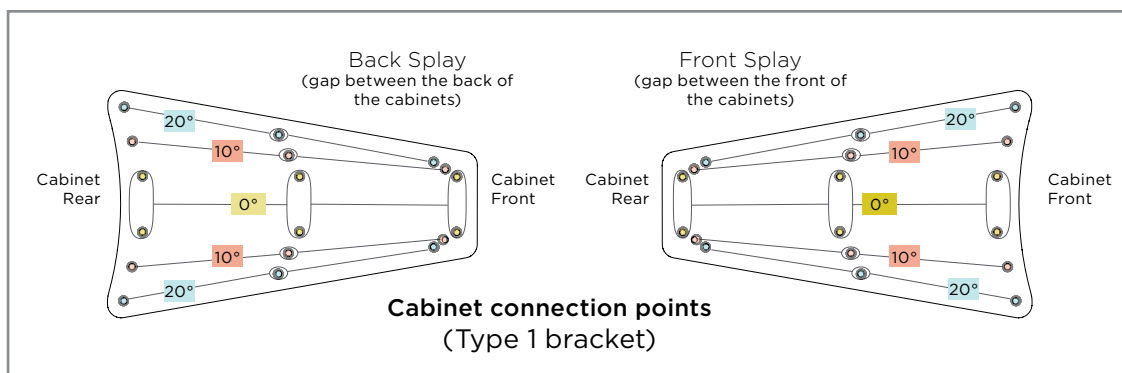

MODELS and ACCESSORIES

Models	Description
LVH-909/APB	LVH-900 60DEG ACTIVE-STD BLK
LVH-909/APW	LVH-900 60DEG ACTIVE-STD WHT
LVH-909WR/APG	LVH-900WR 60DEG ACTIVE-STD GRY
LVH-909WR/APB	LVH-900WR 60DEG ACTIVE-STD BLK
LVH-909WR/APW	LVH-900WR 60DEG ACTIVE-STD WHT
LVH-909C/AP	LVH-900 60DEG ACTIVE-STD CTO
LVH-909WRC/AP	LVH-900WR 60DEG ACTIVE-STD CTO
LVH-909/APB	LVH-900 90DEG ACTIVE-STD BLK
LVH-909/APW	LVH-900 90DEG ACTIVE-STD WHT
LVH-909WR/APG	LVH-900WR 90DEG ACTIVE-STD GRY
LVH-909WR/APB	LVH-900WR 90DEG ACTIVE-STD BLK
LVH-909WR/APW	LVH-900WR 90DEG ACTIVE-STD WHT
LVH-909C/AP	LVH-900 90DEG ACTIVE-STD CTO
LVH-909WRC/AP	LVH-900WR 90DEG ACTIVE-STD CTO

Accessories	Description
LVH-900AFB	LVH-900 ARRAY FRAME BLK
LVH-900AFW	LVH-900 ARRAY FRAME WHT
LVH-900PBB	LVH-900 PULL BACK BAR BLK
LVH-900PBW	LVH-900 PULL BACK BAR WHT
LVH-900SP1B	LVH SPLAY PLATE PAIR TYPE1 BLK
LVH-900SP1W	LVH SPLAY PLATE PAIR TYPE1 WHT
LVH-900SP1G	LVH SPLAY PLATE PAIR TYPE1 GRY
LVH-900SP2B	LVH SPLAY PLATE PAIR TYPE2 BLK
LVH-900SP2W	LVH SPLAY PLATE PAIR TYPE2 WHT
LVH-900SP2G	LVH SPLAY PLATE PAIR TYPE2 GRY

Community L SERIES Beamforming Venue Horn

LVH-909/AP

90° HORIZONTAL DISPERSION,
ACTIVE PLUS, 20°, 80°, 100° VERTICAL DISPERSION,
ARRAYABLE, HIGH OUTPUT LOUDSPEAKER

CONNECTION DIAGRAM

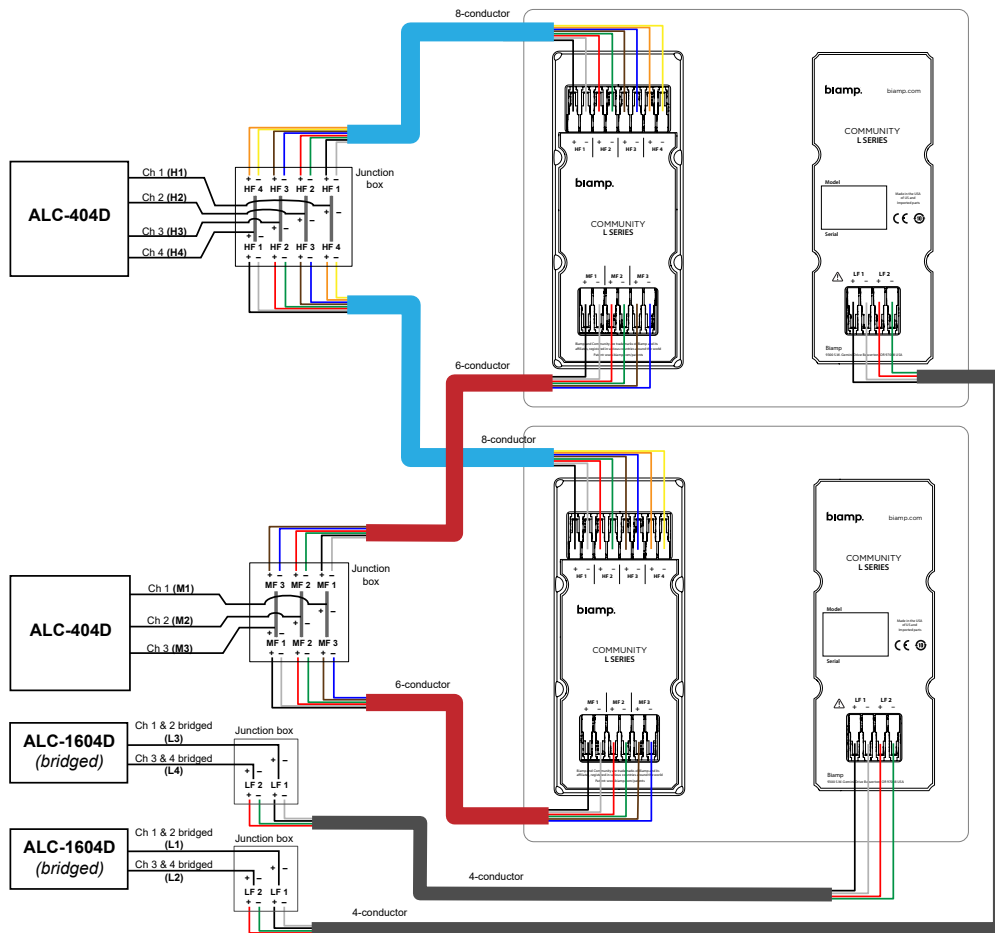

Dual LVH-900/AP with
(2) ALC-404D & (2) ALC-1604D
(11 channels necessary)

Wiring Key

	Color	8-c	6-c	4-c
1 (+)	Black	HF1 (+)	MF1 (+)	LF1 (+)
1 (-)	White	HF1 (-)	MF1 (-)	LF1 (-)
2 (+)	Red	HF2 (+)	MF2 (+)	LF2 (+)
2 (-)	Green	HF2 (-)	MF2 (-)	LF2 (-)
3 (+)	Brown	HF3 (+)	MF3 (+)	
3 (-)	Blue	HF3 (-)	MF3 (-)	
4 (+)	Orange	HF4 (+)		
4 (-)	Yellow	HF4 (-)		

NOTES

- TECHNICAL SPECIFICATIONS** All measurements are performed using a time-windowed impulse response to eliminate reflections, approximating an anechoic environment, at a distance of at least 6.0 m. All acoustic specifications are rounded to the nearest whole number. An external DSP using settings provided by Biamp is required to achieve the specified performance; further performance gains can be realized using the FIR loudspeaker optimization presets available in Biamp's Community Amplified Loudspeaker Controllers (ALCs).
 - OPERATING RANGE** The frequency range over which the on-axis equalized/processed response remains within 10 dB of the rated sensitivity, in accordance with IEC 60268-5.
 - NOMINAL CONTINUOUS POWER HANDLING** The maximum continuous input voltage at the stated nominal impedance that the system can withstand for a period of 2 hours using an IEC 60268-5 defined spectrum with recommended signal processing and protection filters.
 - NOMINAL MAXIMUM SPL** The SPL produced when an IEC 60268-5 signal is applied to the equalized/processed loudspeaker system, at a level which drives at least one subsection to its nominal continuous voltage limit. Referenced to a distance of 1 meter. The peak SPL represents the 2:1 (6 dB) crest factor of the IEC 60268-5 test signal.
 - RATED CONTINUOUS VOLTAGE** The maximum continuous input voltage for the system that results in no more than a 3 dB change in the system's response during operation.
 - RATED MAXIMUM SPL** The SPL produced when a typical program material signal is applied to the equalized/processed loudspeaker system, at a level which drives at least one subsection to its rated continuous voltage limit. Referenced to a distance of 1 meter. The peak SPL represents the 4:1 (12 dB) crest factor of the program signal.
 - AXIAL PROCESSED SENSITIVITY** The variation in acoustic output level with frequency for a 2.83 V_{rms} swept-sine signal using the recommended signal processing. Referenced to 1 meter. The on-axis magnitude and phase responses, as well as the average magnitude response, calculated over one-half of the nominal coverage angles, are shown. The responses have 1/6 octave smoothing applied.
 - HORIZONTAL/VERTICAL OFF-AXIS RESPONSES** The loudspeaker's magnitude response at various off-axis angles using the recommended signal processing in the operating mode which utilizes the largest number of individually amplified pass bands. The responses have 1/3 octave smoothing applied.
 - DIRECTIVITY INDEX** The ratio of the on-axis SPL to the mean SPL at the same distance for all points within the measurement sphere for each given frequency; expressed in dB. The responses have 1/3 octave smoothing applied.
 - BEAMWIDTH** The included angle between the -6 dB points in the polar response of the loudspeaker when driven in the operating mode which utilizes the largest number of individually amplified pass bands. The responses have 1/3 octave smoothing applied.
- Data presented on this spec sheet represents a selection of the basic performance specifications for the model. These specifications are intended to allow the user to perform a fair, straightforward evaluation and comparison with other loudspeaker spec sheets. For a detailed analysis of this loudspeaker's performance, please download the GLL file and/or the CLF file from our website: [\(LVH-900_GLL\)](#)

CAUTION: Installation of loudspeakers should only be performed by trained and qualified personnel. It is strongly recommended that a licensed and certified professional structural engineer approve the mounting design.



A: 9300 S.W. Gemini Drive Beaverton, OR 97008 USA

T: +1 503.641.7287

W: www.biamp.com

COMDS-7047-2203-EN-R2