

DATASHEET

The B-Station is a wall-mount button panel with 6 push-buttons. It can remote control any function within the CueCore or CueluxPro. The buttons are back-lit and can provide visual feedback, for example, to indicate the selected cue or active show.

Multiple B-Stations can be networked together. The button station supports various open protocols like OSC, UDP and Art-Net. This allows it to be integrated with other 3rd party network-based systems as well, e.g. audio, video or show control systems.

For small architectural projects, the B-Station contains an inbuilt lighting controller that is capable of programming 32 fixtures and a maximum of 768 cues. All programming is done via the web-interface, no additional client software is required.

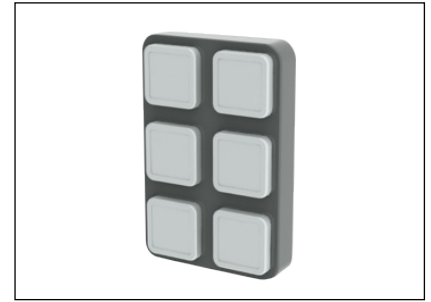

Specifications

- 6 back-lit push-buttons
- Ethernet
- Optically isolated DMX-512 output port
- Programming via web-interface
- Art-Net, OSC & UDP
- PoE (Power over Ethernet) class 1
- Wall-mount
- Shipped with adhesive labels (numbers, icons, colours)

Connection scheme

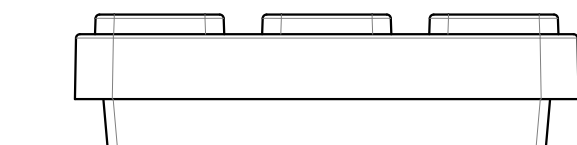
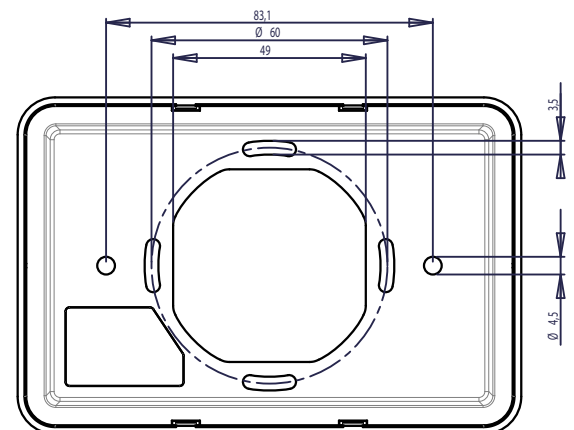
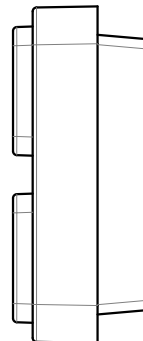
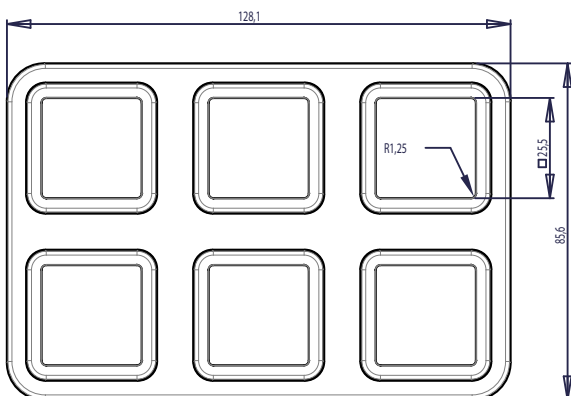
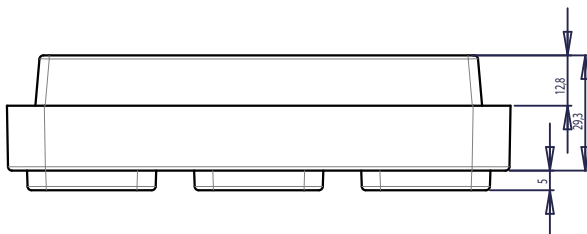
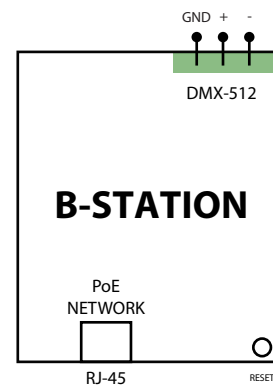

mm