



 **Strand**

ACCLAIM LED CYC

USER MANUAL

INTRODUCTION

OUR GOAL

We are committed to providing you the highest quality in customer service. Our comprehensive resources are available to help your business succeed and ensure you get the full benefit of being a Strand customer.

TECHNICAL SUPPORT

Our Service and Support team is tasked with online and field support, repair, demo, commissioning, maintenance contracts, and technical training for fixtures and systems. In addition, this team plays a large role in a Systems sales, responsible for administering final commissioning, record-keeping, and organizing services. Refer to the back cover of this User Manual for contacts in your region or visit www.vari-lite.com/support

CUSTOMER SERVICE

Customer Service is responsible for boxed goods and spare parts quotations, order entry and fulfilment, project delivery, lead times, and general account management. They also manage all after sales warranty fulfilment, RGA, and repairs invoicing in tandem with our After Sales Service & Support team. Visit our website to find a customer service agent in your region.

ADDITIONAL DOCUMENTATION

Additional product documentation, including DMX maps, software, and photometric reports, are available for download on our website.

For more information on installing DMX512 control systems, the following publication is available for purchase from the United States Institute for Theatre Technology (USITT), "Recommended Practice for DMX512: A Guide for Users and Installers, 2nd edition" (ISBN: 9780955703522).

USITT Contact Information:

USITT

315 South Crouse Avenue, Suite 200

Syracuse, New York 13210-1844 USA

Phone: 800-938-7488 or +1-315-463-6463

Fax: 866-398-7488 or +1-315-463-6525

Website: www.usitt.org

ABOUT THIS DOCUMENT

Read all instructions before installing or using this product. Retain this User Manual for future reference.

Additional product information and descriptions may be found on the product data sheet(s) which can be downloaded from the Vari-Lite website at www.vari-lite.com.

This User Manual provides necessary information regarding safety, installation, operation and routine maintenance for Strand Leko LED Outdoor. Familiarizing yourself with this information will help you to get the most out of your product.

WARNING: It is important to read ALL accompanying safety and installation instructions to avoid damage to the product and potential injury to yourself or others.

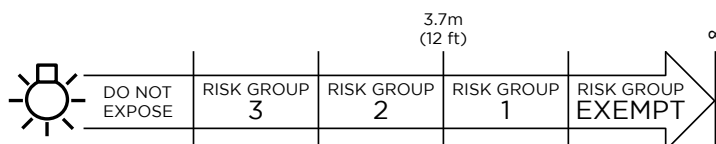

SAFETY WARNINGS AND NOTICES

Read this user manual in full before attempting to install, operate or maintain the fixture to which it relates. This user manual is intended to provide general guidance to such suitably qualified personnel. Installation and operation of the fixture are to be performed by qualified personnel only.

When using electrical equipment, basic safety precautions should always be followed including the following:

READ AND FOLLOW ALL SAFETY INSTRUCTIONS.

- For indoor, dry location use only. Do not use outdoors unless fixture is suitably IP rated.
- Use safety tether when mounting.
- Equipment should be mounted in locations and at heights where it will not be readily subjected to tampering by unauthorized personnel.
- Not for residential use. Do not use this equipment for other than intended use.
- Note distance requirement(s) from combustible materials or illuminated objects. Do not mount near gas or electric heaters.
- Install only in locations with adequate ventilation. Ensure sure that ventilation slots are not blocked.
- Ensure that the voltage and frequency of the power supply match the power requirements of the fixture.
- The fixture must be earthed/grounded to the appropriate conductor.
- Do not operate fixture outside the specified ambient temperature range.
- Do not connect the fixture to any dimmer pack.
- The use of accessory equipment not recommended by the manufacturer may cause an unsafe condition and void warranty.
- Refer service to qualified personnel. This fixture contains no user serviceable parts.
- Prior to first use, carefully inspect fixture to ensure no damage has occurred during shipping.
- Materials used in the manufacturing process can cause strong odors when the product is new. These odors dissipate over time.
- Prior to each use, carefully inspect power cables and replace any damaged cables.
- Exterior surfaces of the luminaire will be hot during operation. Take appropriate precautions.
- Continuous use of the fixture may shorten the lifespan. Power down the fixture when not in use.
- Do not cycle power on and off repeatedly. Disconnect mains power if the fixture is not used for an extended period.
- Clean fixtures regularly, particularly when working in a dusty environment.
- Never touch power cables or wires while the fixture is powered on.
- Avoid entangling power wires with other cables.
- In the event of a serious operating problem, immediately discontinue using the fixture.
- It is hazardous to operate luminaires without lens or shield. Shields, lenses, or ultraviolet screens shall be changed if they have become visibly damaged to such an extent that their effectiveness is impaired, for example, by cracks or deep scratches.
- Original packing materials can be reused for transporting the fixture.
- Do not look directly at the LED light beam while the fixture is on.
- This is a Class A product. In a domestic environment this product may cause radio interference, in which case, the user may be required to take adequate measures.
- The light source contained in this luminaire shall only be replaced by the manufacturer or service agent or similarly qualified person.

SAVE THESE INSTRUCTIONS.

WARNING: Refer to National Electrical Code® and local codes for cable specifications. Failure to use proper cable can result in damage to equipment or danger to personnel. Caution Against Direct Sunlight Through Front Lens Assembly

CAUTION AGAINST DIRECT SUNLIGHT THROUGH FRONT LENS ASSEMBLY

The design and nature of the front lens assembly in Vari-Lite LLC luminaires is to efficiently focus the light energy from the luminaire's lamp for maximum light output.

- When the front lens assembly is exposed to direct sunlight or intense light from neighboring fixtures, the lens will collect and intensify this light and focus it back into the fixture. Intense sunlight or beams from other fixtures can cause damage to internal assemblies contained within the fixture.
- When fixture is not in use and direct sunlight or other intense light is present, position luminaires so their front lens assembly is not directly exposed to the light source.

CAUTION AGAINST POWERING LUMINAIRES FROM DIMMER CIRCUITS

It is not recommended to power any Vari-Lite LLC luminaire from a dimmer - even in 'NONDIM' mode. Dimmer and non-dim modules are not suitable sources of power because their output modifies the AC wave form. This may work for a short time, but eventually results in power problems, luminaire mis-operation and/or failure.

- When using a power distribution rack, do not use dimmer or non-dim modules to power any Vari-Lite LLC luminaire. Damage to the luminaire can occur.
- Using a dimmer or non-dim module to power your Vari-Lite LLC luminaire will void your luminaire's warranty.

CAUTION AGAINST THE USE OF THIRD PARTY PARTS OR ACCESSORIES

- Heat and heat distribution are important factors when operating Vari-Lite LLC luminaires. Vari-Lite LLC luminaires are designed to dissipate heat efficiently and safely. Any blockages or obstructions, such as aftermarket baffles, covers, enclosures, etc. can interrupt the luminaire's ability to dissipate heat properly and can damage the luminaire.
- Vari-Lite LLC cannot be responsible for issues arising from non-approved parts and accessories installed on or used with any Vari-Lite LLC product. Customers of such products should contact the manufacturer directly for assistance and support.

TRANSPORTING LUMINAIRES

When shipping or transporting luminaires, Vari-Lite LLC recommends that the luminaire(s) be sufficiently protected against any (including, but not limited to) shock, vibration, drops, jarring, exposure to the environment, etc.

Failure to sufficiently protect any Vari-Lite LLC luminaire during shipping or transportation will result in damage and void the luminaire's warranty. Vari-Lite LLC will not be responsible for any shipping damage or breakage of any product under any circumstances. Vari-Lite LLC will not be responsible for any third party case manufacturer's cases.

NOTE: As with all automated luminaires, proper handling and suitable protective shipping cases should be used when transporting fixtures to reduce the risk of damage.

TRANSPORTATION AND SHIPPING CASE REQUIREMENTS

Cases to transport Vari-Lite LLC luminaires should meet the following loading requirements:

- Luminaire head, yoke, and enclosure sub-assemblies shall be equally supported and constrained where no one sub-assembly (head, yoke, or enclosure) fully supports the entire mass of the luminaire.
- The interior of the case shall be of high quality and uniform density foam. The foam shall be of the same type and density throughout as to equally and uniformly support loading at every contact surface.
- The case shall, when laid on any of its six (6) surfaces, maintain the loading requirements outlined above.
- All cases not meeting the aforementioned loading requirements, with wheels, shall have markings on the exterior of the case that the unit is to be transported on its wheels only (e.g. "Case must be transported and remain [at all times] on its wheels").

COMPLIANCE NOTICE



FCC DECLARATION OF CONFORMITY

This equipment has been tested and found to comply with the limits for a Class A digital device pursuant to Part 15 of FCC Rules. These limits are designed to provide reasonable protection against harmful interference when this equipment is operated in a commercial environment. This equipment generates, uses, and can radiate radio frequency energy and, if not installed and used in accordance with Vari-Lite Strand system, service, and safety guidelines, may cause harmful interference to radio communications.

As tested under this standard:

FCC 47CFR 15B cIA*CEI

Issued:2009/10/01 Title 47 CFR Part 15 Subpart B Unintentional Radiators Class A

Operation of this equipment in a residential area is likely to cause harmful interference, in which case the user will be required to correct the interference at his/her own expense.



EU DECLARATION OF CONFORMITY

We, Vari-Lite LLC., 10911 Petal Street, Dallas, Texas 75238, declare under our responsibility for the products contained herein are in conformity with the essential requirements of the following European Directives and harmonized standards:

Low Voltage Director (LVD), 2006/95/EC

EN 60589-2-17:1984+A1:1987+A2:1990 used in conjunction with 60598-1:2008/A11:2009

Electromagnetic Compatibility Directive (EMC), 2004//108/EC

EN 55022:2010, EN55024:2010

HOW TO OBTAIN WARRANTY SERVICE

A copy of the Limited Warranty card was included in the shipping package for this product.

To obtain warranty service, please contact customer service at 1-214-647-7880, or **entertainment.service@signify.com** and request a Return Material Authorization (RMA) for warranty service. You will need to provide the model and serial number of the item being returned, a description of the problem or failure and the name of the registered user or organization. If available, you should have your sales invoice to establish the date of sale as the beginning of the warranty period. Once you obtain the RMA, pack the unit in a secure shipping container or in its original packing box. Be sure to clearly indicate the RMA number on all packing lists, correspondence, and shipping labels. If available, please include a copy of your invoice (as proof of purchase) in the shipping container.

With the RMA number written legibly on or near the shipping address label, return the unit, freight prepaid, to:

Vari-Lite LLC
Attention: Warranty Service (RMA# _____)
10911 Petal Street
Dallas, Texas 75238
USA

As stated in the warranty, it is required that the shipment be insured and FOB our service center.

IMPORTANT! When returning products to Vari-Lite Strand for repairs (warranty or out-of-warranty) from a country other than the USA, "Vari-Lite LLC", must appear in the address block as the Importer of Record (IOR) on all shipping documentation, Commercial Invoices, etc. This must be done in order to clear customs in a timely manner and prevent returns.

1 DESCRIPTION

FEATURES

- Delivers the performance of a 500 W cyclight with a maximum power consumption of 145 W with a smooth even field for cycloramas up to 5m / 16ft high.
 - Simple spacing system 1.2m - 4ft from cyc surface 1.4m / 4.5ft on center spacing.
 - Designed for top or floor mounting with kick stand yoke.
 - Infinite color choice from the RGBL engine and color temperatures in white.
 - Homogenized fully mixed color output light, no multiple color shadows.
 - Constant color balance down to very low light levels irrespective of intensity setting.
 - True asymmetrical patented reflector technology.
 - RDM controls and setup of fixture allows device settings to be configured remotely.
 - Color Calibration.
 - Multiple fan/noise control modes and options.
 - Fresnel, Profile Light engine and Zoomspot available
- For detailed product information, please refer to the Product Guide at <https://www.vari-lite.com/global/products/acclaim-led-cyc>

COMPONENTS

The document provides installation and operation instructions for the following products:

- Strand Acclaim LED Cyc

Read all instructions before installing or using this product. Retain this manual for future reference. Additional product information and descriptions may be found on the product specification sheet.

INCLUDED ITEMS

Each Strand Acclaim LED Cyc luminaire includes the following items:

- Strand Acclaim LED Cyc
- Quick Start Guide

2 INSTALLATION

MOUNTING

The unit should be mounted via its screw holes on the bracket. Always ensure that the unit is firmly fixed to avoid vibration and slipping while operating. When installing the fixture, always use a safety cable that is certified to hold up to 12 times the fixture's own weight.

The luminaire must be installed by qualified professionals.

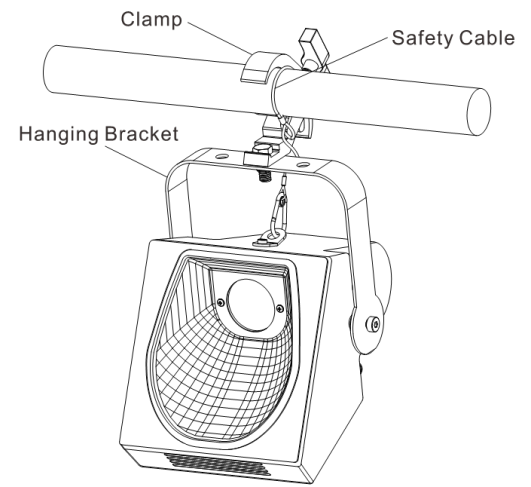

CONNECTING DATA AND POWER

A maximum of 32 luminaires may be connected in any one DMX data link.

A maximum of 9 luminaires may be connected in 120V, 60Hz.

A maximum of 16 luminaires may be connected in 230V, 50Hz.

NOTE: This maximum limit applies to the luminaire “daisy chain” only. Your system or console may require fewer luminaires on a single data link path. Consult your console documentation for more information.

To connect power and data:

- Step 1. Connect data cable from console to first luminaire in chain at DATA IN connector.
- Step 2. If required, connect additional data cables from DATA THRU connectors to DATA IN connectors of remaining luminaires in link.
- Step 3. At last luminaire in link, install male termination connector at DATA THRU connector. (Luminaires and other devices on the same DMX chain may not function properly without termination.)

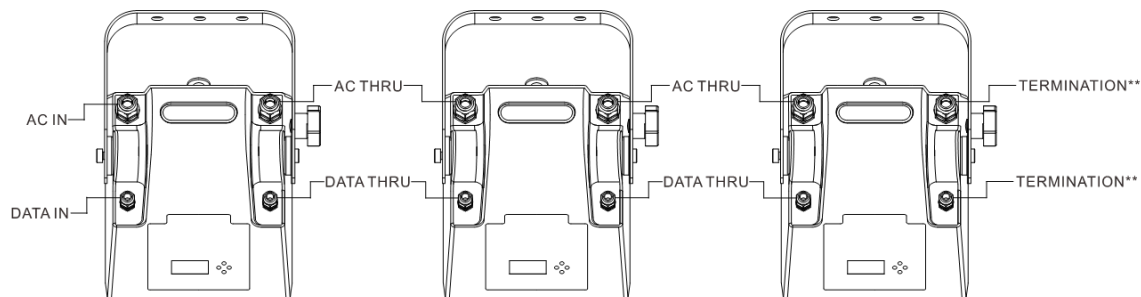

- Step 4. Connect AC Input Cable connector to power input source.
- Step 5. Dress AC input and data cables and secure them so that they will not interfere with luminaire head and yoke movement.

3 MENU OPERATION

CONTROL PANEL

Press the MENU button to select any functions, until the required function is shown in the display. Select the desired function by pressing ENTER, which will cause the display to blink. Use the UP and DOWN button to change the mode. Once the required mode has been selected, press the ENTER button to accept the selection. Press MENU to return to the previous menu or let the unit idle for one minute to exit menu mode automatically.

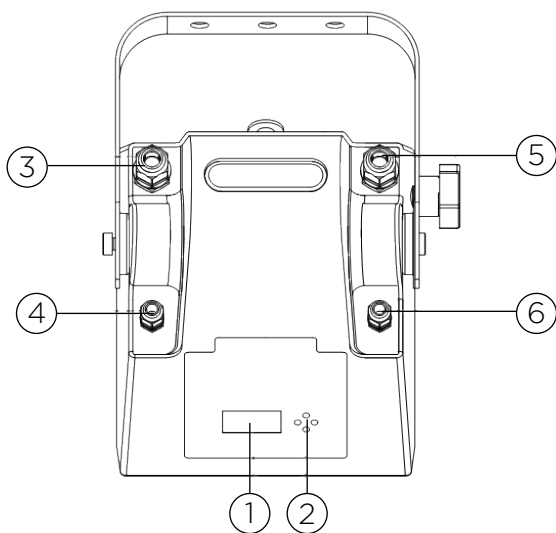

- ① **LCD DISPLAY.** Shows the menu and selected function buttons.
- ② **BUTTONS.**
Menu. To select programming functions.
Down. To go forward in the selected functions.
Up. To go backward in the selected functions.
Enter. To confirm the selected functions.
- ③ **POWER IN.** Connects to power supply.
- ④ **DMX/RDM IN.** 5-pin XLR cable to link DMX console.
- ⑤ **POWER THRU.** Connects to next fixture.
- ⑥ **DMX/RDM THRU.** 5-pin XLR cable to the next unit.

QUICK REFERENCE MENU KEY SHORTCUTS

MENU KEY SHORTCUTS	FUNCTION
MENU+ENTER	Factory Defaults
ENTER+UP	Shortcut to turn the fixture on at full output
ENTER+DOWN	Shortcut to toggle through the STANDARD, STUDIO and WHISPER Mode
UP+DOWN	Display Invert

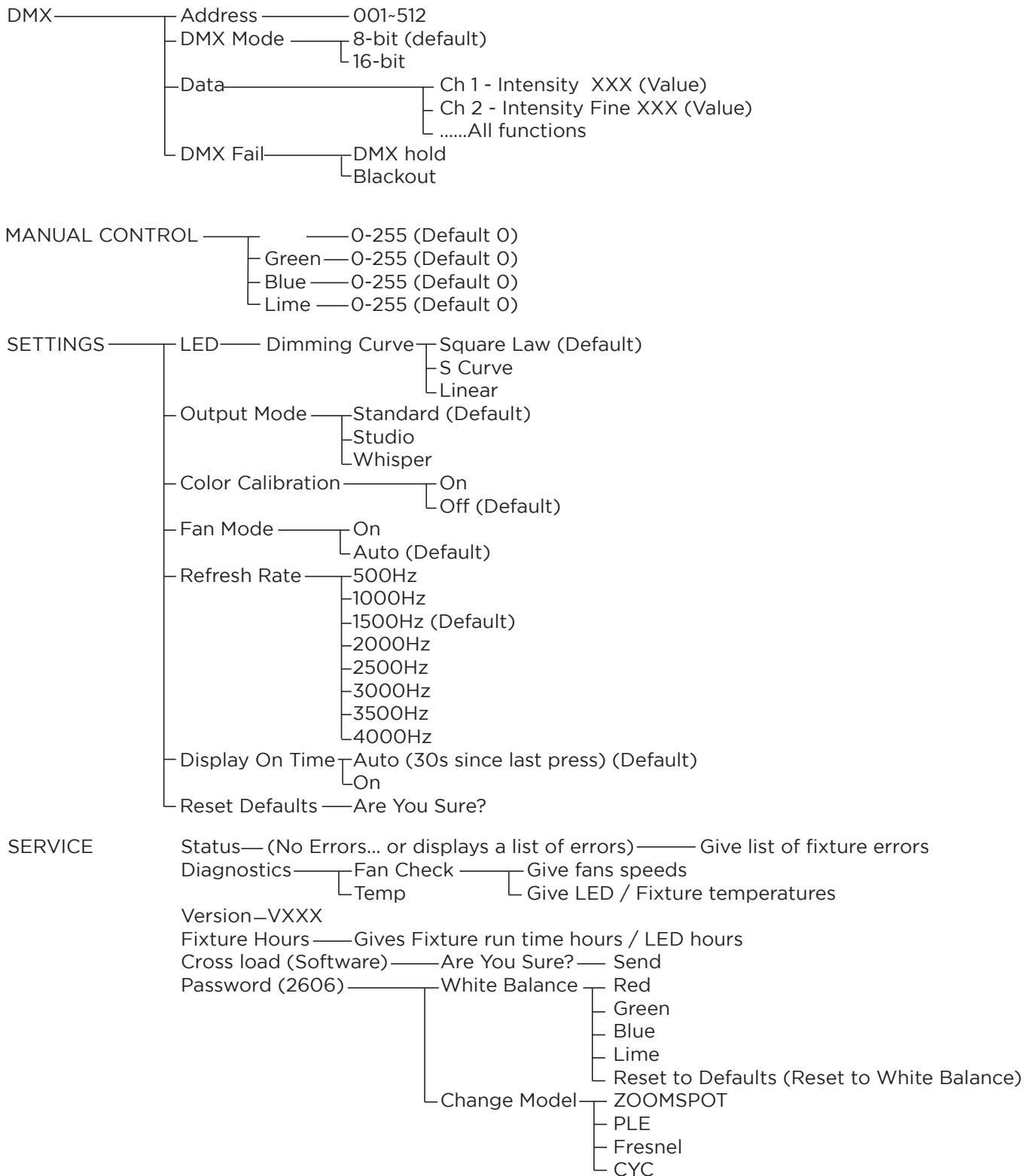

DMX MENU

Address

To select DMX Address, press the ENTER button to confirm. Use the UP/DOWN button to adjust the address from 001 to 512, press the ENTER button to store. Press the MENU button back to the last menu or let the unit idle one minute to exit menu mode.

DMX Mode

To select DMX Mode, press the ENTER button to confirm. Use the UP/DOWN button to select 8 - Bit or 16 - Bit, press the ENTER button to store. Press the MENU button back to the last menu or let the unit idle one minute to exit menu mode.

Data

To select Data, press the ENTER button to confirm. Use the UP/DOWN button to select Ch1 – Intensity xxx(value), Ch2 – Intensity Fine xxx(Value), All functions, press the ENTER button to store. Press the MENU button back to the last menu or let the unit idle one minute to exit menu mode.

Dmx Fail

To select Dmx Fail, press the ENTER button to confirm. Use the UP/DOWN button to select DMX Hold or Blackout, press the ENTER button to store. Press the MENU button back to the last menu or let the unit idle one minute to exit menu mode.

MANUAL MENU

To select Manual, press the ENTER button to confirm, use the UP/DOWN button to select Red, Green, Blue and Lime. Use the UP/DOWN button to adjust the value from 0 to 255, press the ENTER button to store. Press the MENU button back to the last menu or let the unit idle one minute to exit menu mode.

SETTINGS MENU

To select Settings, press the ENTER button to confirm, use the UP/DOWN button to select LED, Display On Time and Reset Defaults.

LED

To select LED, press the ENTER button to confirm. Use the UP/DOWN button to select Dimming Curve, Output Mode, Color Calibration, Fan Mode and Refresh Rate. Press the ENTER button to store. Press the MENU button back to the last menu or let the unit idle one minute to exit menu mode.

Dimming Curve – To select Dimming Curve, press the ENTER button to confirm. Use the UP/DOWN button to select Square Law, S Curve or Linear, press the ENTER button to store. Press the MENU button back to the last menu or let the unit idle one minute to exit menu mode.

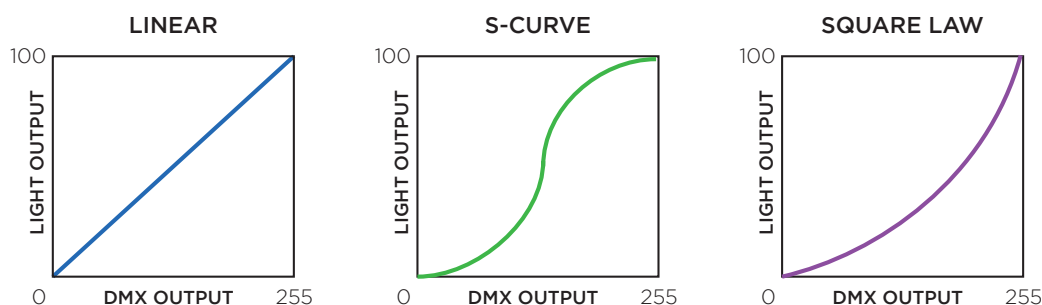

Output Mode – To select Output Mode, press the ENTER button to confirm. Use the UP/DOWN button to select Standard, Studio or Whisper, press the ENTER button to store. Press the MENU button back to the last menu or let the unit idle one minute to exit menu mode.

Color Calibration – To select Color Calibration, press the ENTER button to confirm. Use the UP/DOWN button to select On or Off, press the ENTER button to store. Press the MENU button back to the last menu or let the unit idle one minute to exit menu mode.

Fan Mode – To select Fan Mode, press the ENTER button to confirm. Use the UP/DOWN button to select On or Auto, press the ENTER button to store. Press the MENU button back to the last menu or let the unit idle one minute to exit menu mode.

Refresh Rate – To select Refresh Rate, press the ENTER button to confirm. Use the UP/DOWN button to select 500Hz, 1000Hz, 1500Hz, 2000Hz, 2500Hz, 3000Hz, 3500Hz, 4000Hz, press the ENTER button to store. Press

the MENU button back to the last menu or let the unit idle one minute to exit menu mode.

Display On Time

To select Display On Time, press the ENTER button to confirm. Use the UP/DOWN button to select Auto(30 seconds since last press) or On, press the ENTER button to store. Press the MENU button back to the last menu or let the unit idle one minute to exit menu mode.

Reset Defaults

To select Reset Defaults, press the ENTER button to confirm, Are You Sure? will show on the display, press the ENTER button to store. Press the MENU button back to the last menu or let the unit idle one minute to exit menu mode.

SERVICE MENU

To select Service, press the ENTER button to confirm, use the UP/DOWN button to select Status, Diagnostics, Version, Fixture Hours, Crossload(Software) and Password(2606).

Status

To select Status, press the ENTER button to confirm, No Errors or a list of errors will show on the display, press the MENU button back to exit.

Diagnostics

To select Diagnostics, press the ENTER button to confirm. Use the UP/DOWN button to select Fan Check or Temp, press the ENTER button to store. Press the MENU button back to the last menu or let the unit idle one minute to exit menu mode.

Version

To select Version, press the ENTER button to confirm, Version will show on the display, press the MENU button back to exit.

Fixture Hours

To select Fixture Hours, press the ENTER button to confirm, Fixture Hours will show on the display, press the MENU button back to exit.

Crossload(Software)

Select Crossload(Software), press the ENTER button to confirm, Are You Sure? will show on the display, press the ENTER button to store. Press the MENU button back to the last menu or let the unit idle one minute to exit menu mode.

NOTE: Incoming DMX must be removed from the fixture or software crossload will not be activated.

Password(2606)

Select Password(2606), press the ENTER button to confirm. Use the UP/DOWN button to select White Balance or Change Mode, press the ENTER button to store. Press the MENU button back to the last menu or let the unit idle one minute to exit menu mode.

White Balance — To select White Balance, press the ENTER button to confirm. Use the UP/DOWN button to select Red, Green, Blue, Lime or Reset to Defaults (Reset to White Balance), press the ENTER button to store. Press the MENU button back to the last menu or let the unit idle one minute to exit menu mode.

Change Mode — To select Change Mode, press the ENTER button to confirm. Use the UP/DOWN button to select ZOOMSPOTM, PLE, Fresnel or CYC, press the ENTER button to store. Press the MENU button back to the last menu or let the unit idle one minute to exit menu mode.

5 RDM PARAMETER IDS

The following tables outline and describe all the RDM parameters IDs associated with the Acclaim LED Cyc luminaire.

MODEL ID	MANUFACTURER	VENDOR ID	MODEL DESCRIPTION	PRODUCT CATEGORY
0x0314	Strand	0x736C	ACCLAIM LED CYC	0x0101

GET ALLOWED	SET ALLOWED	RDM PARAMETER IDS	VALUE	COMMENT	ESTA STANDARD	REQUIRED / IMPLEMENTED
		Category - Network Management				
		DISC_UNIQUE_BRANCH	0x0001		■	■
		DISC_MUTE	0x0002		■	■
		DISC_UN_MUTE	0x0003		■	■
■		PROXIED_DEVICES	0x0010			
■		PROXIED_DEVICES_COUNT	0x0011			
■	■	COMMS_STATUS	0x0015			
		Category - Status Collection				
■		QUEUED_MESSAGE	0x0020			
■		STATUS_MESSAGES	0x0030			■
■		STATUS_ID_DESCRIPTION	0x0031			■
	■	CLEAR_STATUS_ID	0x0032			
■	■	SUB_DEVICE_STATUS_REPORT_THRESHOLD	0x0033			
		Category - RDM Information				
■		SUPPORTED_PARAMETERS	0x0050		■	■
■		PARAMETER_DESCRIPTION	0x0051		■	■
		Category - Product Information				
■		DEVICE_INFO	0x0060		■	■
■		PRODUCT_DETAIL_ID_LIST	0x0070			
■		DEVICE_MODEL_DESCRIPTION	0x0080			■
■		MANUFACTURER_LABEL	0x0081			■
■	■	DEVICE_LABEL	0x0082			■
■	■	FACTORY_DEFAULTS	0x0090			■
■		LANGUAGE_CAPABILITIES	0x00A0			
■	■	LANGUAGE	0x00B0			
■		SOFTWARE_VERSION_LABEL	0x00C0		■	■
■		BOOT_SOFTWARE_VERSION_ID	0x00C1			
■		BOOT_SOFTWARE_VERSION_LABEL	0x00C2			
		Category - DMX512 Setup				
■	■	DMX_PERSONALITY	0x00E0			■
■		DMX_PERSONALITY_DESCRIPTION	0x00E1			■
■	■	DMX_START_ADDRESS	0x00F0		■	■
■		SLOT_INFO	0x0120			■
■		SLOT_DESCRIPTION	0x0121			■
■		DEFAULT_SLOT_VALUE	0x0122			■

GET ALLOWED	SET ALLOWED	RDM PARAMETER IDS	VALUE	COMMENT	ESTA STANDARD	REQUIRED / IMPLEMENTED
		Category - Sensors 0x02xx USE				
■		SENSOR_DEFINITION	0x0200			■
■	■	SENSOR_VALUE	0x0201	Fan Speed and Temperatures		■
	■	RECORD_SENSORS	0x0202			
		Category - Dimmer Settings 0x03xx - FUTURE USE				
■	■	Dimmer Curve	0x0343			■
■		Dimmer Curve Description	0x0344			■
■	■	Modulation Frequency	0x0347			■
■		Modulation Frequency Description	0x0348			■
		Category - Power / Lamp Settings 0x04xx				
■	■	DEVICE_HOURS	0x0400			■
■	■	LAMP_HOURS	0x0401			
■	■	LAMP_STRIKES	0x0402			
■	■	LAMP_STATE	0x0403			
■	■	LAMP_ON_MODE	0x0404			
■	■	DEVICE_POWER_CYCLES	0x0405			
		Category - Display Settings 0x05xx				
■	■	DISPLAY_INVERT	0x0500			
■	■	DISPLAY_LEVEL	0x0501			
		Category - Configuration 0x06xx				
■	■	PAN_INVERT	0x0600			
■	■	TILT_INVERT	0x0601			
■	■	PAN_TILT_SWAP	0x0602			
■	■	REAL_TIME_CLOCK	0x0603			
		Category - Control 0x10xx				
■	■	IDENTIFY_DEVICE	0x1000		■	■
	■	RESET_DEVICE	0x1001			■
■	■	POWER_STATE	0x1010			
■	■	PERFORM_SELFTEST	0x1020	All Test, Pan/Tilt, Encoder		
■		SELF_TEST_DESCRIPTION	0x1021			
	■	CAPTURE PRESET	0x1030	See E1-20_2010a		
■	■	PRESET PLAYBACK	0x1031	Table A-7 defines		

GET ALLOWED	SET ALLOWED	RDM PARAMETER IDS	VALUE	COMMENT	ESTA STANDARD	REQUIRED / IMPLEMENTED
		ESTA Reserved Future RDM Manufacturer-Specific PIDs	0x7FE0-0x7FFF 0x8000-0xFFDF			
■	■	Output Power Mode	0x8A97	Value range depends on options (Standard, Studio, etc)		■
■	■	Pan/Tilt Feedback (On/Off)	0x8AD3			
■	■	Display On Time	0x8AA0	Value range depends on options		■
■	■	LED Dimmer Curve	0x8AA1	Value range depends on options		
■	■	Pan Tilt Movement (On/Off)	0x8AA2			
■	■	Head Motor Movement (On/Off)	0x8AA3			
■	■	Auto Shutdown Mode	0x8AA4	Value range depends on options		
■	■	LED Hours	0x8AA5			
■	■	Dim Snap (On/Off)	0x8AA6			
■	■	Color Snap (On/Off)	0x8AA7			
■	■	Auto Fan Mode (On/Off)	0x8AA8			
■	■	Gamma Shift	0x8AA9	Value range depends on options		
■	■	Tungsten Dimming (On/Off)	0x8AAA			
■	■	CTB Correction (On/Off)	0x8AAB			
■	■	LED Refresh Rate	0x8AAC	Value range depends on options		
■	■	Side Hang (On/Off)	0x8AAD			
■	■	Focus Track (On/Off)	0x8AAE			
■	■	Control Signal select DMX only/ARTNET (On/Off)	0x8AAF			
	■	Recalibrate Fixture (Level)	0x8AB0	different levels (all, position, color, etc)		
■	■	DMX Fail (Hold, Blackout, GOTO Preset)	0x8AB1			
■	■	ArtNet Universe	0x8AB2			
■	■	ArtNet Net	0x8AB3			
■	■	ArtNet Sub-Net	0x8AB4			
■	■	ArtNet Ethernet IP	0x8AB5			
■	■	ArtNet Ethernet Sub-Net Mask	0x8AB6			
■	■	Manual PRESET Playback Power Up Preset	0x8AB7			
■	■	Manual PRESET Playback Preset Intensity	0x8AB8			
■	■	Manual PRESET Playback Priority	0x8AB9			
■	■	Manual PRESET Playback Power Up?	0x8ABA			
■	■	LED Color Calibration (On/Off)	0x8ABB			■

APPENDIX A

CARE AND MAINTENANCE

TROUBLESHOOTING

The following are a few common problems that may occur during operation.

Luminaire does not work; light and fan do not turn on.

- Check power connection and main fuse.
- Measure the mains voltage on the main connector.

Not responding to DMX controller.

- If DMX LED is not illuminated, verify that the DMX cables are properly connected.
- If the DMX LED is illuminated and there is no response, verify DMX address settings and the DMX polarity.
- If you experience intermittent DMX signal problems, check the pins on the connectors or on the PCB.
- Test with a different DMX controller.
- Check if the DMX cables run near or alongside high voltage cables that may cause interference to the DMX interface circuit.

CLEANING

Cleaning the inside of the luminaire must be carried out periodically in order to optimize the light output. Cleaning frequency depends on the environment in which the fixture operates. Damp, smoky or particularly dusty surroundings can cause greater accumulation of dirt on the fixture's optics.

- Clean with a soft cloth using glass cleaning fluid.
- Dry parts carefully.
- Clean the external optics at least every 30 days.

APPENDIX B

FAN SPEED AND CONTROL

All Vari-lite and Strand lighting luminaires are governed by the same fan speed versus noise levels and maximum power output rules as detailed below. The noise related to these levels conforms to noise criteria levels detailed within the document.

There are three control parameters that can be selected separately or in conjunction when permitted to manage fan speed versus noise levels and maximum power output.

NOTE: Not all fixture have all modes or functions. Refer to DMX map and/or user interface menu tree to verify the modes and functions in your fixture.

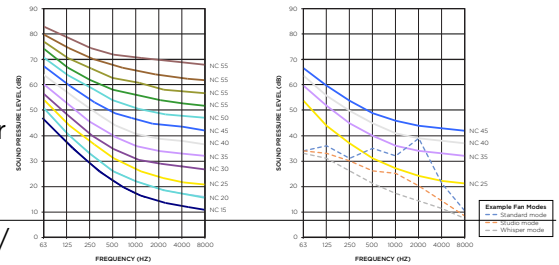

FAN VERSUS OUTPUT PRESET MODES

These modes are selectable at either / or the fixtures DMX control channel or via the fixture user interface screen.

Boost mode - LED output boosted to >120% of standard output fan speeds increased manage heat level of LED (may be limited to only run for XXhrs). Fixture will not exceed NC45 - NC55 sound levels in this mode

Standard mode - Full LED Output + Fan Spin at top speed (loudest setting). Fixture will not exceed NC40 sound levels in this mode.

Studio mode - Fan speed reduced to appropriate amount to reduce dB levels >10% of full speed + LED @ max output approximately 80% of Standard output at appropriate level to ensure LED work at optimum temperature and output efficiency (fan speed remains at a constant speed and do not ramp up or down) NC35.

Whisper mode - Fan speed reduced to appropriate amount to reduce dB levels to >30% of the full speed + LED Max output approximately 60% of Standard output at appropriate level to ensure LED work at optimum temperature and output efficiency (Fan speed remains at a constant speed and do not ramp up or down) NC25.

Silent mode - ideally Fans do not spin + output capped at appropriate level to ensure LED work at optimum temperature and output efficiency (Fan should never switch on in this mode or change speed if they on) NC15 target level.

MODE	LED OUTPUT	FAN SPEED	NOISE CRITERION	EQUIVALENT SOUND LEVEL DBA (@3M)
Boost Mode	>100%	Boosted fan speed constant	NC45	50
Standard Mode	Full 100%	Full 100% constant	NC40	45
Studio Mode	80%	Appropriate speed to reduce dB levels >10% of full speed	NC35	40
Whisper Mode	60%	Appropriate speed to reduce dB levels >30% of full speed	NC25	35
Silent Mode	TBC	Fan off	NC15	25

NOISE CRITERION	OCTAVE BAND CENTER FREQUENCY (HZ)							
	63	125	250	500	1000	2000	4000	8000
	SOUND PRESSURE LEVELS (DB)							
NC-15	47	36	29	22	17	14	12	11
NC-20	51	40	33	26	22	19	17	16
NC-25	54	44	37	31	27	24	22	21
NC-30	57	48	41	35	31	29	28	27
NC-35	60	52	45	40	36	34	33	32
NC-40	64	56	50	45	41	39	38	37
NC-45	67	60	54	49	46	44	43	42
NC-50	71	64	58	54	51	49	48	47
NC-55	74	67	62	58	56	54	53	52
NC-60	77	71	67	63	61	59	58	57
NC-65	80	75	71	68	66	64	63	62
NC-70	83	79	75	72	71	70	69	68

TECHNICAL SUPPORT

GLOBAL 24HR TECHNICAL SUPPORT:

Call: +1 214 647 7880

entertainment.service@signify.com

NORTH AMERICA SUPPORT:

Call: 877-VARI-LITE (877-827-4583)

entertainment.service@signify.com

EUROPEAN CUSTOMER SERVICE CENTER:

Call: +31 (0) 543 542 531

entertainment.europe@signify.com

© 2022 Signify Holding. All rights reserved. All trademarks are owned by Signify Holding or their respective owners. The information provided herein is subject to change, without notice. Signify does not give any representation or warranty as to the accuracy or completeness of the information included herein and shall not be liable for any action in reliance thereon. The information presented in this document is not intended as any commercial offer and does not form part of any quotation or contract, unless otherwise agreed by Signify. Data subject to change.

ACCLAIM LED CYC USER MANUAL

VERSION DATE: DECEMBER 29 2022