

User Manual
V1.0.B0.CTM0101

VIP

DRIVE 10-5 Nova



Model ID: VIPDRIVE105NOVA

Edition Notes

The VIP Drive 10-5 Nova User Manual includes a description, safety precautions, installation, programming, operation and maintenance instructions for the VIP Drive 10-5 Nova as of the release date of this edition.

Trademarks

CHAUVET, the Chauvet logo and VIP Drive 10-5 Nova are registered trademarks or trademarks of Chauvet & Sons, LLC (d/b/a Chauvet and Chauvet Lighting) in the United States and other countries. Other company and product names and logos referred to herein may be trademarks of their respective companies.

Copyright Notice

The works of authorship contained in this manual, including, but not limited to, all design, text and images are owned by Chauvet.

© **Copyright 2022 Chauvet & Sons, LLC. All rights reserved.**

Electronically published by Chauvet in the United States of America.

Manual Use

Chauvet authorizes its customers to download and print this manual for professional information purposes only. Chauvet expressly prohibits the usage, copy, storage, distribution, modification, or printing of this manual or its content for any other purpose without written consent from Chauvet.

Document Printing

For best results, print this document in color, on letter size paper (8.5 x 11 in), double-sided. If using A4 paper (210 x 297 mm), configure the printer to scale the content accordingly.

Intended Audience

Any person installing, operating, and/or maintaining this product should completely read through the guide that shipped with the product, as well as this manual, before installing, operating, or maintaining this product.

Disclaimer

Chauvet believes that the information contained in this manual is accurate in all respects. However, Chauvet assumes no responsibility and specifically disclaims any and all liability to any party for any loss, damage or disruption caused by any errors or omissions in this document, whether such errors or omissions result from negligence, accident or any other cause. Chauvet reserves the right to revise the content of this document without any obligation to notify any person or company of such revision, however, Chauvet has no obligation to make, and does not commit to make, any such revisions. Download the latest version from www.chauvetprofessional.com.

Document Revision

This VIP Drive 10-5 Nova User Manual is the 1st edition of this document. Go to www.chauvetprofessional.com for the latest version.

TABLE OF CONTENTS

1. Before You Begin	1
What Is Included	1
Claims	1
Text Conventions	1
Symbols	1
Safety Notes.....	2
Personal Safety.....	2
Mounting and Rigging	2
Power and Wiring.....	2
Operation	2
2. Introduction.....	3
Description	3
Features	3
Product Overview.....	4
Front Panel Overview.....	4
Control Panel Description.....	4
Rear Panel Overview	5
Rear Panel Description.....	5
Product Dimensions	6
3. Setup.....	7
AC Power	7
AC Plug	7
Mounting	7
Signal Connections	7
Video Source Connection	7
NovaLCT Connection.....	7
Input Connections Diagram.....	8
Output Connections Diagram.....	8
Cascading Connection	9
Cascading USB Connection Diagram.....	9
GenLock Synchronization	9
GenLock Connection Diagram	9
Fiber Optic Connection via SFP Modules	10
Fiber Converter Mode.....	10
Fiber Optic Backup	11
Fiber Optic Copy.....	12
4. Operation.....	13
Control Panel Description	13
Programming.....	13
Menu Lockout Function.....	13
Menu Map	13
Operating Settings Configuration	22
Home Screen	22
Screen Brightness.....	23
Screen Configuration	23
Quick Configuration	23
More Settings	25
Layer Settings	27
Layer Status	28
Input Source	28
Scaling Mode	28
Layer Priority	28
Layer Input Crop.....	29
Layer Opacity	29
Input Settings	29
HDMI and DVI EDID Settings.....	29
Input Color Settings.....	31
Color Space/Sample Rate	31
Convert Limited RGB to Full RGB	31
Input MOSAIC	32

Preset Settings.....	33
Save Preset.....	33
Load Preset.....	33
Clear Preset.....	33
Copy Preset.....	33
Image Mosaic.....	34
Total Image Mosaic Pixels.....	34
Load Area Dimensions.....	34
Load Area Offset.....	34
Image Mosaic Reset.....	34
Display Control.....	35
Output Status.....	35
Test Pattern.....	35
Main Layer Transition.....	36
Transition Duration.....	36
Fade To Black Duration.....	36
Advanced Settings.....	37
Device Backup.....	37
Input Backup.....	37
Synchronization.....	38
HDMI Output.....	38
Audio Settings.....	39
Input High-Bandwidth Digital Content Protection.....	39
Latency Reduction.....	39
3D Mode.....	40
OPT 2 Mode.....	41
System Settings.....	41
Shortcut Button <FN>.....	41
Home Screen Timeout.....	41
Diagnostics.....	41
Firmware Version.....	42
Factory Reset.....	42
Communication.....	42
Communication Mode.....	42
Network.....	42
Working Mode.....	43
Fiber Converter Menu.....	44
语言/Language.....	44
NovaLCT Software.....	45
Software Setup.....	45
Screen Configuration.....	45
Sending Card Tab.....	46
Receiving Card Tab.....	46
Screen Connection Tab.....	47
VIP Drive 10-5 Nova Firmware Update Through NovaLCT.....	48
Video Product Firmware Update Through NovaLCT.....	48
Standalone Video Product Update.....	49
5. Maintenance.....	50
Product Maintenance.....	50
6. Technical Specifications.....	51
Returns.....	52
Contact Us.....	53

Before You Begin

1. Before You Begin

What Is Included

- VIP Drive 10-5 Nova
- IEC power cord
- USB cable
- HDMI signal cable
- DVI signal cable
- Cat5e ethernet 3 ft jumper cable
- Quick Reference Guide

Claims

Carefully unpack the product immediately and check the container to make sure all the parts are in the package and are in good condition.



If the box or the contents (the product and included accessories) appear damaged from shipping, or show signs of mishandling, notify the carrier immediately, not Chauvet. Failure to report damage to the carrier immediately may invalidate your claim. In addition, keep the box and contents for inspection.

For other issues, such as missing components or parts, damage not related to shipping, or concealed damage, file a claim with Chauvet within 7 days of delivery.

Text Conventions

Convention	Meaning
1–512	A range of values
50/60	A set of values of which only one can be chosen
Settings	A menu option not to be modified
<ENTER>	A key to be pressed on the product's control panel

Symbols

Symbol	Meaning
	Critical installation, configuration, or operation information. Not following these instructions may make the product not work, cause damage to the product, or cause harm to the operator.
	Important installation or configuration information. The product may not function correctly if this information is not used.
	Useful information.

Safety Notes

Read all the following safety notes before working with this product. These notes contain important information about the installation, usage, and maintenance of this product.



This product contains no user-serviceable parts. Any reference to servicing in this User Manual will only apply to properly trained, certified technicians. Do not open the housing or attempt any repairs.



All applicable local codes and regulations apply to proper installation of this product.

Personal Safety

- Always connect the product to a grounded circuit to avoid the risk of electrocution.
- Do not touch the product's housing when operating because it may be very hot.

Mounting and Rigging

- This product is for indoor use only! To prevent risk of fire or shock, do not expose this product to rain or moisture. (IP20)
- CAUTION: When transferring product from extreme temperature environments, (e.g., cold truck to warm, humid ballroom) condensation may form on the internal electronics of the product. To avoid causing a failure, allow product to fully acclimate to the surrounding environment before connecting it to power.
- Mount this product in a location with adequate ventilation, at least 20 in (50 cm) from adjacent surfaces.
- Make sure there are no flammable materials close to the product when operating.

Power and Wiring

- Make sure the power cord is not crimped or damaged.
- Always make sure you are connecting this product to the proper voltage in accordance with the specifications in this manual or on the product's specification label.
- To eliminate unnecessary wear and improve its lifespan, during periods of non-use completely disconnect the product from power via breaker or by unplugging it.
- Never connect this product to a dimmer pack or rheostat.
- Never disconnect this product by pulling or tugging on the power cable.

Operation

- Do not operate this product if there is damage on the housing or cables. Have the damaged parts replaced by an authorized technician at once.
- Do not cover the ventilation slots when operating to avoid internal overheating.
- Operating Temperature: -4 °F to 122 °F (-20 °C to 50 °C).
- In the event of a serious operation problem, stop using this product immediately!



If your Chauvet product requires service, contact Chauvet Technical Support.

2. Introduction

Description

The VIP Drive 10-5 Nova is an all-in-one video processor that outputs signal to any NovaStar video panel. The integrated 3-layer Scaler supports full screen, pixel to pixel, and custom scaling options. Standalone mapping configures most video walls without a computer, and the custom mapping function provides on-screen visual feedback. The VIP Drive 10-5 Nova supports 4K at 6.55 million LED resolution with 10 Ethernet video outputs.

Features

- Video wall processor that outputs video signal to any NovaStar video panel
- Integrated 3-layer Scaler supports full screen, pixel to pixel, and custom scaling options
- Automatically scales to the wall detected
- Powerful standalone mapping configures most video walls without a computer
- Custom MAPPING function makes setting up your wall fast and easy with on-screen visual feedback
- Specialized on-screen mapping overlay makes mapping fast and easy by identifying the port and order of each video panel live, while video continues to play in the background.
- 10 Ethernet video outputs support 4K at 6.55 million LED resolution
- Works with NovaLCT software for complex configurations and panel calibration
- Compact 1U packaging eases transportation and integration into your existing setup
- Fiber SFP output for all 10 ports of the processor (primary and backup)
- 1 of the fiber SFP ports may be used as a direct video input
- Mode selection in menu allows the processor to function as a regular video controller to screen, a fiber converter to input fiber and output to your screen from another video controller, or in Bypass mode for automatic fault detection and backup from another primary video controller
- GenLock input and loop supports synchronizing multiple VIP processors and with your video source (switcher) to eliminate scan lines on camera.
- MOSAIC function allows you to use multiple video inputs on the screen at the same time (2x DVI or 2x HDMI)
- Video backup settings allow you to designate backup video inputs for increased stability
- HDMI Video output enables previewing video sources and monitoring screen output locally
- Image Mosaic function supports synchronizing multiple VIP Drive 10-5 Nova processors, up to 32,768 x 32,768 total resolution
- Supports output LED screen refresh rate 23.98 - 120 Hz
- Low latency, 3D features supported in the drive

Product Overview

Front Panel Overview

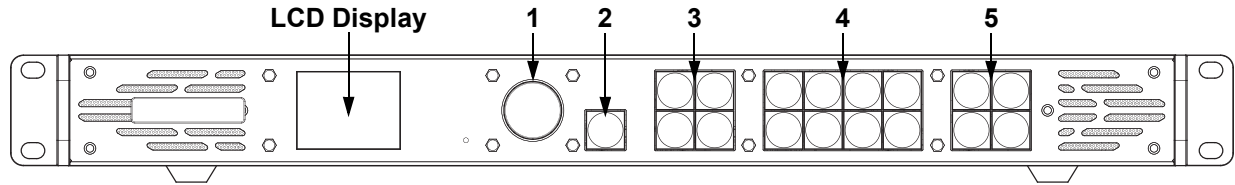

Control Panel Description

#	Name	Function	
1	<MENU> Knob	Rotate to navigate upwards or downwards through the menu list, and increase or decrease a selected numeric value. Push to enable the currently displayed menu option or set the currently selected value into the selected function.	
2	<ESC>	Exits the current menu or function	
3	CONTROL buttons	<MAIN>	Accesses the layer menus (Main, PIP1, and PIP2) and displays the layer status. <ul style="list-style-type: none"> On (blue light) – Layer is opened. Flashing (blue light) – Layer is being edited. On (white light) – Layer is closed.
		<PIP1>	
		<PIP2>	
		<SCALE>	Fills the entire screen with the lowest-priority layer: <ul style="list-style-type: none"> On (blue light) – Full-screen scaling activated. On (white light) – Full-screen scaling deactivated.
4	INPUTS buttons	<HDMI 1 / 1>	Switches the layer input source (or enters the corresponding number) and displays the status of the input source: <ul style="list-style-type: none"> On (blue light) – Input source in use Flashing (blue light) – Input source used by the layer On (white light) – Input source not in use or not normal
		<HDMI 2 / 2>	
		<DVI 1 / 3>	
		<DVI 2 / 4>	
		<SDI / 6>	
		<OPT 1-1 / 7>	
		<OPT 1-2 / 8>	
<MOSAIC / 9>			
5	FUNCTION buttons	<PRESET / 5>	Navigates to the Preset Settings menu or enters the number 5
		<TEST>	Navigates to the Test Pattern menu
		<FREEZE / 0>	Freezes video output or enters the number 0
		<FN>	Customizable function

Introduction

Rear Panel Overview

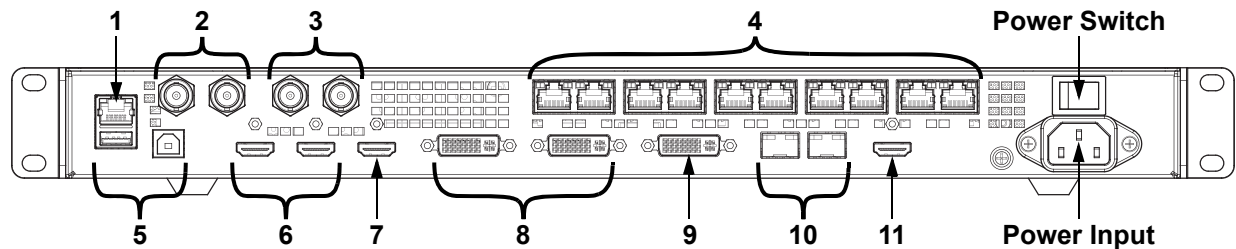

Rear Panel Description

#	Name	Function
1	ETHERNET	RJ45 port for connecting to a personal computer
2	GENLOCK IN GENLOCK LOOP	Locking BNC connectors for signal synchronization of devices with an external video switcher or clock generator
3	3G-SDI IN 3G-SDI LOOP	3G-SDI video port supporting deinterlacing processing but not input resolution or bit depth settings 3G-SDI video loop output port
4	OUTPUT 1-10	RJ45 ports for output to LED video products. Ports 1 and 2 have audio output support for use with a multifunction card to parse audio.
5	USB (Type A) USB (Type B)	USB type A output port for cascading to other devices USB type B input port for cascading from other devices or connecting to a personal computer
6	HDMI 1.4 1 IN HDMI 1.4 1 LOOP	HDMI video input port supporting interlaced signal inputs. Supports mosaic of 2 HDMI 1.4 inputs. HDMI 1.4 video loop output port for the HDMI1 input
7	HDMI 1.4 2	HDMI video input port supporting interlaced signal inputs. Supports mosaic of 2 HDMI 1.4 inputs.
8	DVI (HDMI 1.4) 1 IN DVI (HDMI 1.4) 1 LOOP	DVI video input port supporting interlaced signal inputs. Supports mosaic of 2 HDMI 1.4 inputs. DVI video loop output port for the DVI1 input
9	DVI (HDMI 1.4) 2	DVI video input port supporting interlaced signal inputs. Supports mosaic of 2 HDMI 1.4 inputs.
10	OPT 1-1 OPT 1-2	SFP ports (master and backup) for sending/receiving fiber optic data at distance via SFP modules
11	HDMI 1.3	HDMI 1.3 video output port for monitor

Product Dimensions

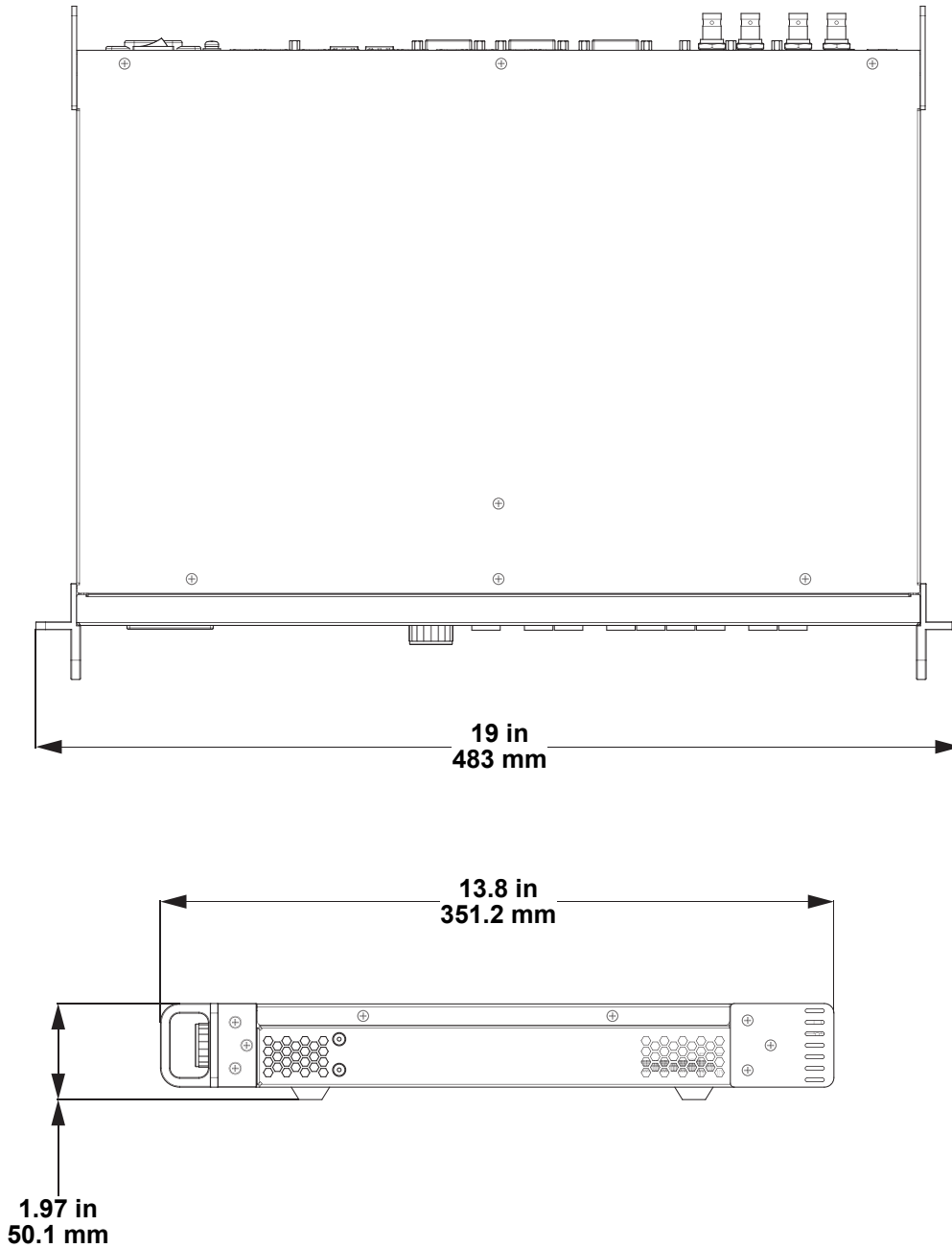

3. Setup

AC Power

The VIP Drive 10-5 Nova has an auto-ranging power supply and it can work with an input voltage range of 100 to 240 VAC, 50/60 Hz.

To determine the product's power requirements (circuit breaker, power outlet, and wiring), use the current value listed on the label affixed to the product's back panel, or refer to the product's specifications chart. The listed current rating indicates the product's average current draw under normal conditions.



- **Always connect the product to a protected circuit (a circuit breaker or fuse). Make sure the product has an appropriate electrical ground to avoid the risk of electrocution or fire.**
- **To eliminate unnecessary wear and improve its lifespan, during periods of non-use completely disconnect the product from power via breaker or by unplugging it.**



- **Never connect the product to a rheostat (variable resistor) or dimmer circuit, even if the rheostat or dimmer channel serves only as a 0 to 100% switch.**

AC Plug

The VIP Drive 10-5 Nova comes with a power input cord terminated with an IEC connector on one end and an Edison plug on the other end (U.S. market). If the power input cord that came with your product has no plug, or if you need to change the plug, use the table below to wire the new plug.

Connection	Wire (U.S.)	Wire (Europe)	Screw Color
AC Live	Black	Brown	Yellow or Brass
AC Neutral	White	Blue	Silver
AC Ground	Green/Yellow	Green/Yellow	Green

Mounting

The VIP Drive 10-5 Nova fits nicely on a standard 19" rack, or it can be placed on its rubber feet on a flat level surface.

Signal Connections

The VIP Drive 10-5 Nova uses the NOVA control protocol to send video signal to the connected panels. The VIP Drive 10-5 Nova has USB and Ethernet ports for interfacing with a computer, HDMI, DVI, SDI and fiber optic ports for sending/receiving at distance, as well as 10 RJ45 out ports and GenLock in and loop connectors.

Video Source Connection

You can link the VIP Drive 10-5 Nova directly to a video source using a DVI connection, an HDMI connection, or an SDI connection.

NovaLCT Connection

You can link the VIP Drive 10-5 Nova to a computer running the NovaLCT software using a USB (type A or B) connection or an ethernet cable. This will provide control options for the VIP Drive 10-5 Nova through a computer interface.

Input Connections Diagram

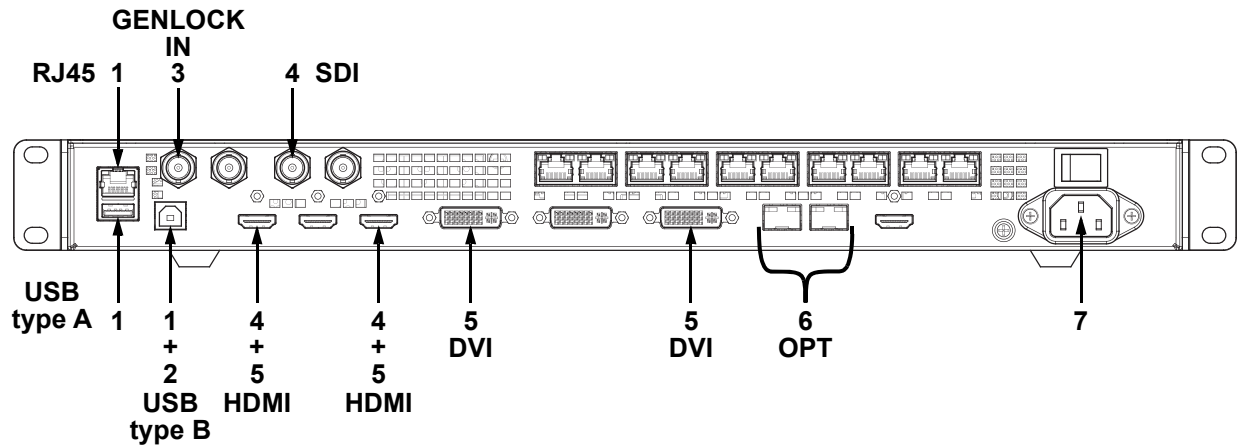

#	Purpose	Connections
1	Interface with a computer running NovaLCT software	USB type A and B, Ethernet
2	Link to another VIP Drive 10-5 Nova	USB Type B
3	Synchronize with a video switcher, a clock generator, another VIP Drive 10-5 Nova, or another compatible product connected to the aforementioned	GENLOCK IN
4	Link to a video device, such as a camera or a DVD player	3G-SDI, HDMI 1.4
5	Link to a computer video output	HDMI 1.4, DVI
6	Receive processed video output from another VIP Drive 10-5 Nova at distance via SFP modules and fiber optic cable	OPT (SFP Port)
7	Receive AC power	IEC

Output Connections Diagram

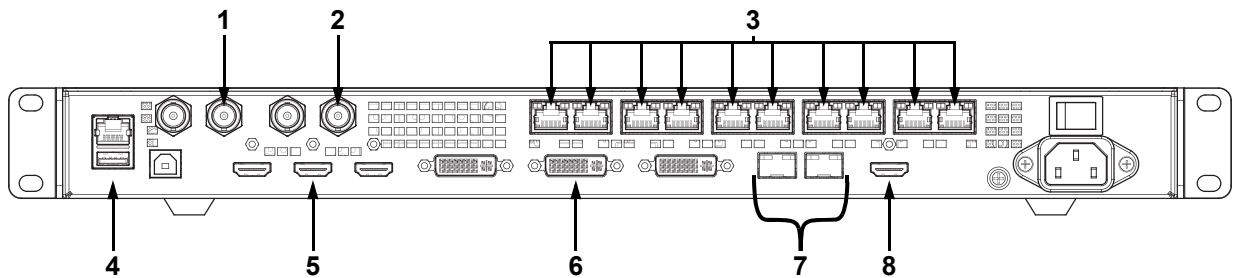

#	Receiving Device	Connections
1	Another VIP Drive 10-5 Nova or another product to be synchronized to the same video switcher or clock generator	GENLOCK LOOP
2	Another VIP Drive 10-5 Nova	3G-SDI LOOP
3	LED video panels, such as the F2 from CHAUVET	RJ45
4	Another VIP Drive 10-5 Nova	USB type A
5	Another VIP Drive 10-5 Nova	HDMI 1.4 LOOP
6	Another VIP Drive 10-5 Nova	DVI (HDMI 1.4) LOOP
7	Another VIP Drive 10-5 Nova via SFP modules and fiber optic cable	OPT (SFP Port)
8	Preview monitor	HDMI 1.3

Setup

Cascading Connection

Multiple VIP Drive 10-5 Nova products can be linked together in a cascading connection using the USB type A and B ports on the rear panel of the product. This will allow all products to be programmed at once.

Cascading USB Connection Diagram

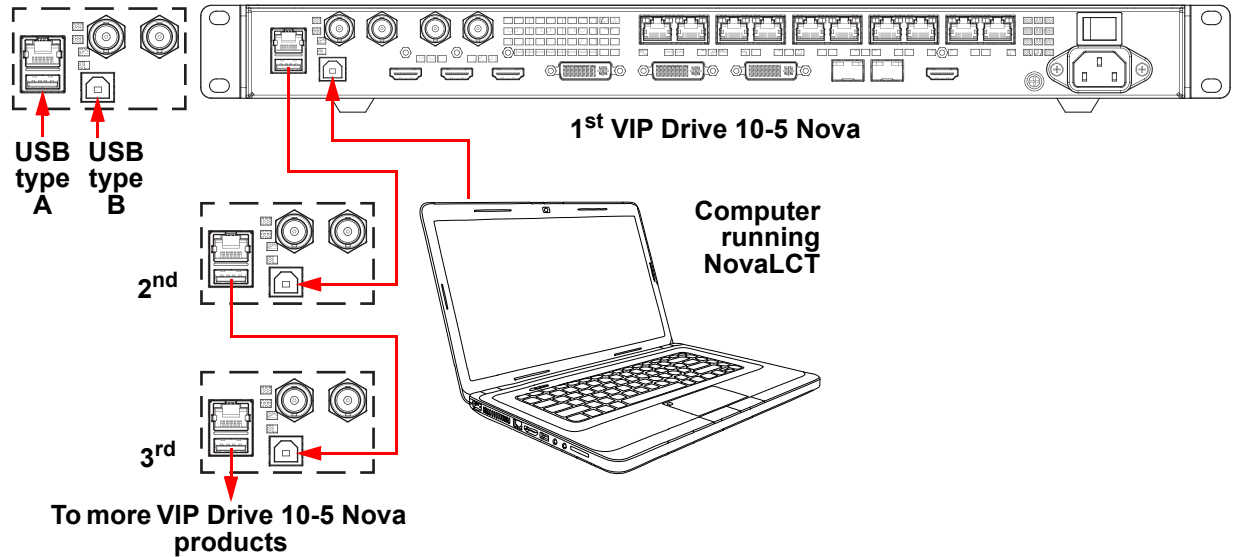

GenLock Synchronization

The VIP Drive 10-5 Nova has 2 locking BNC connectors for GenLock synchronization.

- GENLOCK IN is for receiving the synchronization signal from a video switcher or a clock generator either directly or via another product.
- GENLOCK LOOP is for sending a synchronization signal to another product, such as a camera.

This function is essential for systems with multiple VIP Drive 10-5 Nova products and/or for systems being filmed.



Any input source can be used as a synchronization source. See [Synchronization](#) for more information.

GenLock Connection Diagram

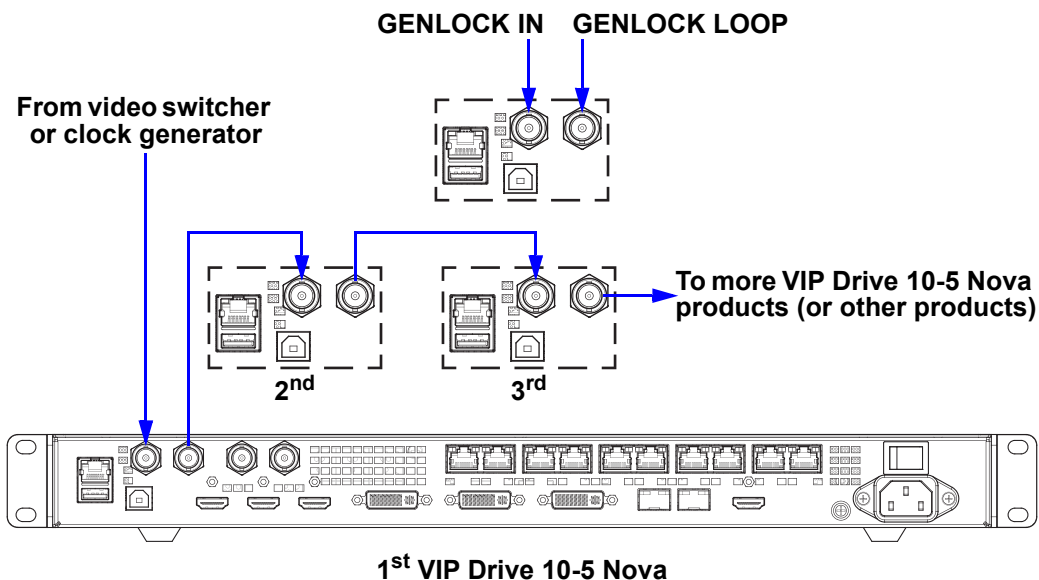

Fiber Optic Connection via SFP Modules

The VIP Drive 10-5 Nova has 2 SFP ports (labeled OPT) which are compatible with SFP modules which fit the following specifications:

- Module Type: SFP
- Wavelength: 1310-nm
- Data Rate: 10Gb/s
- Fiber Type: Dual LC Single-mode fiber
- Temperature: 0-70°C
- Distance: 10km
- Hot Pluggable
- 20-pin connector

Fiber Converter Mode

One VIP Drive 10-5 Nova can be set up to send processed video data via a fiber optic connection over distance, while another VIP Drive 10-5 Nova can be set up to receive fiber optic data and output to connected video products.

- Set the [Device Backup](#) for the sending VIP Drive 10-5 Nova products to **Primary**.
- Set the [OPT 2 Mode](#) for the sending VIP Drive 10-5 Nova products to **Copy**.
- Set the [Working Mode](#) for the sending VIP Drive 10-5 Nova products to **Video Controller**.
- Set the [Working Mode](#) for the receiving VIP Drive 10-5 Nova to **Fiber Converter**.



When in Fiber Converter mode, the OPT 2 SFP port is intended to be used as a redundant backup. This is automatic and no extra configuration is needed.

Fiber Converter Mode Diagram

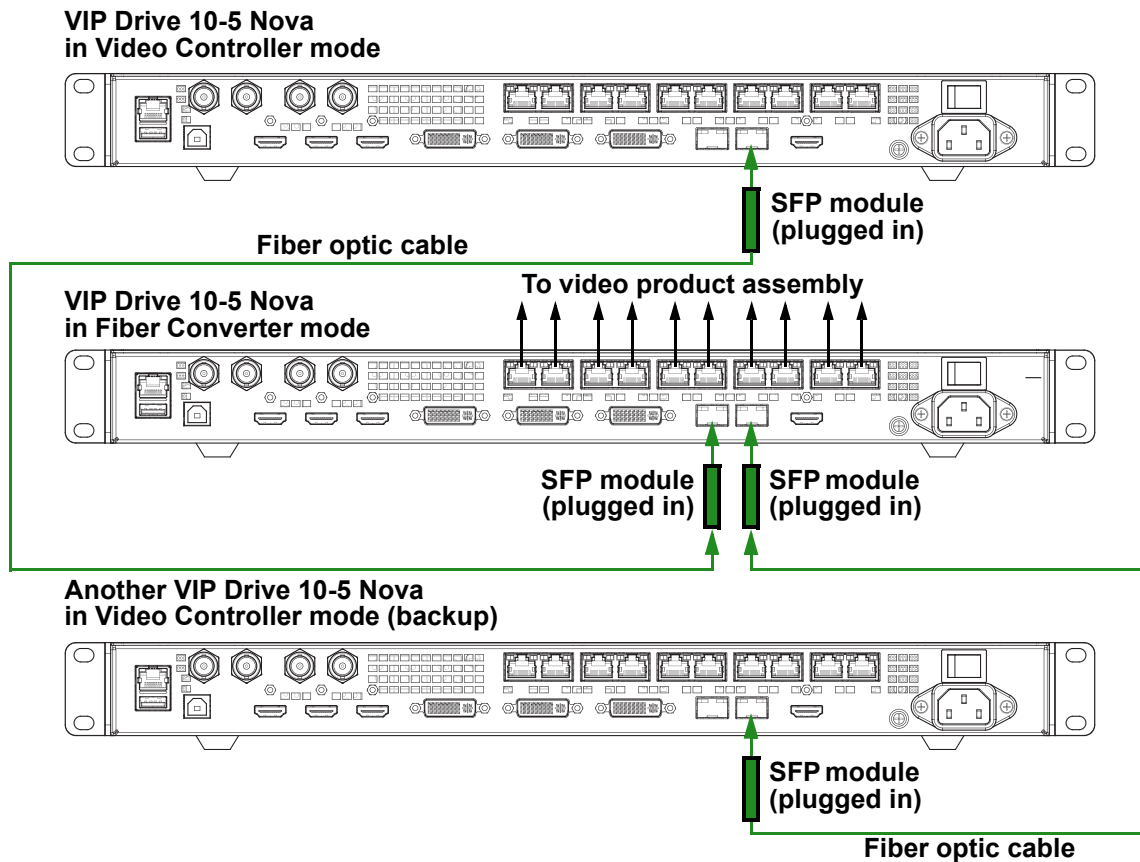

Setup

Fiber Optic Backup

A VIP Drive 10-5 Nova can receive a backup signal from the OPT 2 SFP port of another VIP Drive 10-5 Nova.

- Set the [Device Backup](#) for the sending VIP Drive 10-5 Nova to **Primary**.
- Set the [OPT 2 Mode](#) for the sending VIP Drive 10-5 Nova to **Backup**.
- Set the [Working Mode](#) for the sending VIP Drive 10-5 Nova to **Video Controller**.
- Set the [Working Mode](#) for the backup VIP Drive 10-5 Nova to **Fiber Converter**.

Fiber Optic Backup Diagram

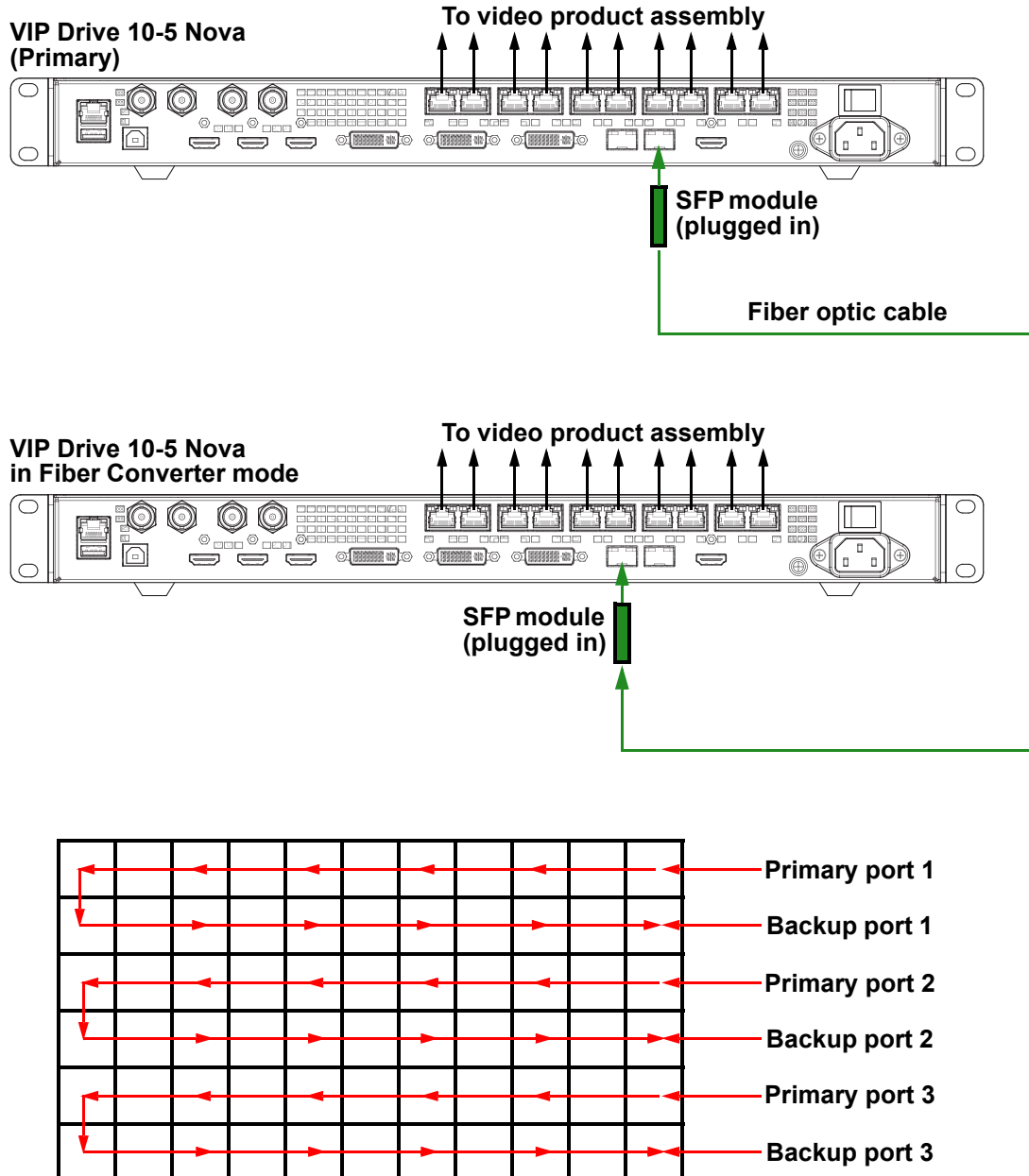

Fiber Optic Copy

At the same time as a VIP Drive 10-5 Nova is sending its output to a connected video product assembly, it can copy that output data and send it to another VIP Drive 10-5 Nova via the OPT 2 SFP port. This way multiple video product assemblies can display the same content.

- Set the [OPT 2 Mode](#) for the sending VIP Drive 10-5 Nova to **Copy**.
- Set the [Working Mode](#) for the sending VIP Drive 10-5 Nova to **Video Controller**.
- Set the [Working Mode](#) for the receiving VIP Drive 10-5 Nova to **Fiber Converter**.

Fiber Optic Copy Diagram

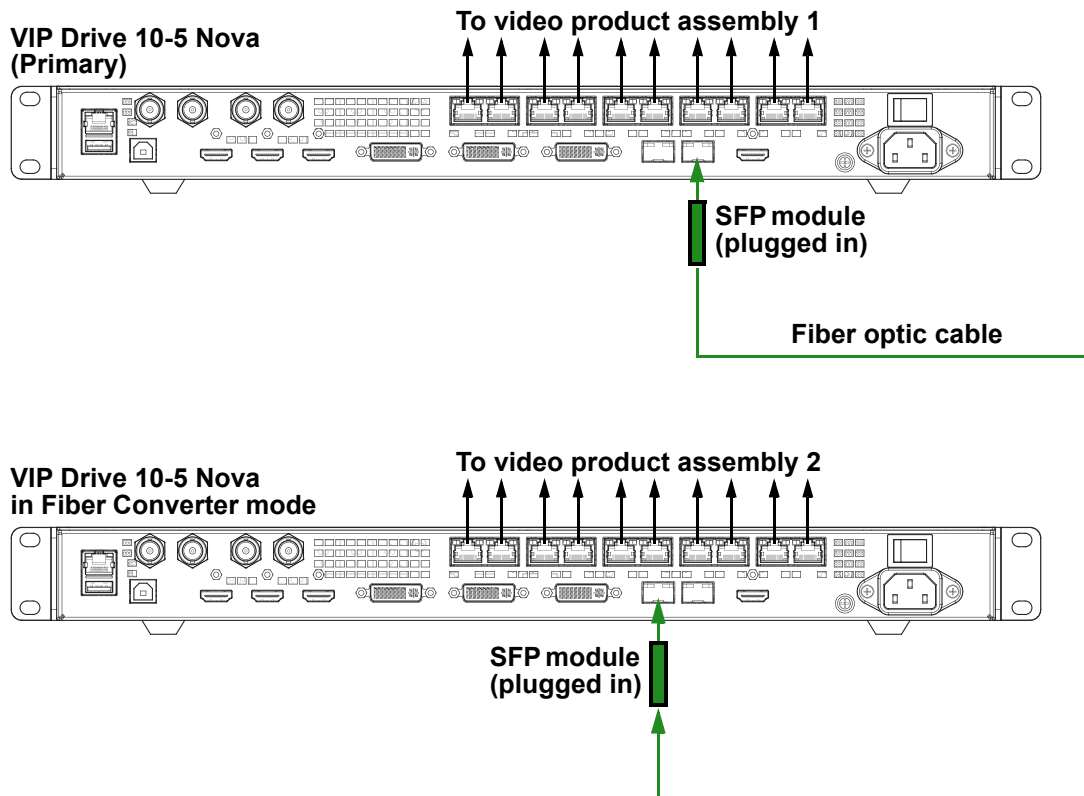

4. Operation

Control Panel Description

See the [Product Overview](#) for a detailed description of the control panel.

Programming

Refer to the Menu Map to understand the menu options. The menu map shows the main level and a variable number of programming levels for each option.

- To access the menu from the Home Screen, press the **<MENU>** knob.
- To scroll through the options on each level of the menu, turn the **<MENU>** knob. Turn it clockwise to scroll down, and turn it counter-clockwise to scroll up.
- Press the **<MENU>** knob to select the highlighted option. This will take you to the next programming level for that option, or it will highlight a value that can be edited.
- To increase a selected number value, turn the **<MENU>** knob clockwise. To decrease a selected number value, turn the **<MENU>** knob counter-clockwise.
- Press **<ESC>** to exit to the previous main level, press repeatedly to return to the Home Screen.

Menu Lockout Function

To prevent accidental changes to the menu or functions, lock the menu by pressing and holding the **<MENU>** knob and **<ESC>** for 4-5 seconds. Repeat to unlock the menu.

Menu Map

Refer to the VIP Drive 10-5 Nova product page on www.chauvetvideo.com for the latest menu map.

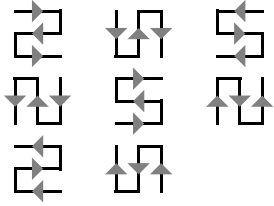

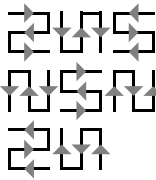
Main Level	Programming Levels		Description		
Screen Brightness	0–100%		Controls total output level		
Screen Configuration	Quick Configuration	Cabinet Row Qty	1–64*	Sets number of rows in video assembly. *Range based on Column Qty and connected products.	
		Cabinet Column Qty	1–80*	Sets number of columns in video assembly. *Range based on Row Qty and connected products.	
		Port1 Cabinet Qty	1*–46*	Sets number of video products connected to Output Port 1. *Range varies by panel used, from one tenth of total connected products to 40*.	
		Data Flow (Front View)		Sets start point and path for data flow in video product assembly	
	Send RCFGx Files		No Files	Sends RCFGx files to the receiving cards of the connected assembly	
	Save to RV Card		No	Permanently saves uploaded firmware to connected products	
			Yes		
	More Settings	Advanced Configuration	No		Accesses the Advanced Configuration menu
			Yes		
			Status	On	Enables/disables separate configuration for each port
			Off		
Ethernet Port	1–10	Selects the port to configure			
	Cabinet Row Qty	1–40	Sets number of rows from the selected port		

Main Level	Programming Levels		Description	
Screen Configuration (cont.)	More Settings (cont.)	Advanced Configuration (cont.)	Cabinet Column Qty 1–40 Sets number of columns from the selected port	
			Horizontal Offset 0–10112 Sets horizontal offset for the selected port. *Range based on Column Qty.	
			Vertical Offset 0–8064 Sets vertical offset for the selected port. *Range based on Row Qty.	
			Data Flow (Front View)  Sets start point and path for data flow from the selected port	
			Apply Applies the selected configuration	
			Reset Resets the advanced configuration	
		Mapping	Off Enables/disables mapping function	
			On	
		LED Screen Color	Gamma 1.0–4.0 Sets the Gamma value	
			Temperature	Standard
				Cool
				Warm
				Custom
	R		000–255 Sets the custom color temperature values	
	G			
	B			
	Reset Resets the screen color settings			
	Output Frame Rate	23.98	Selects preset output frame rate	
		24		
		25		
		29.97		
		30		
		47.95		
48				
50				
59.94				
60				
71.93				
72				
75				
85				
100				
119.88				
120				

Main Level	Programming Levels		Description		
Layer Settings	Main Layer	Status	On	Activates/deactivates the selected layer	
			Off		
		Input Source	HDMI1	Sets the input source for the selected layer	
			HDMI2		
			DVI1		
			DVI2		
			SDI		
			OPT1-1		
			OPT1-2		
		MOSAIC			
	Scaling Mode	Full Screen	Scales the layer to the entire connected video assembly		
		Pixel to Pixel	Scales the layer 1:1		
		Custom	Scales the layer manually		
	PIP1	H Width	64–32768	Sets the layer width	
	PIP2	V Height	64–32768	Sets the layer height	
		Initial X	-32768–32768	Sets the layer's horizontal offset	
		Initial Y	-32768–32768	Sets the layer's vertical offset	
		Priority	1–3	Sets the layer's priority level	
	Input Crop	Status	On	Activates/deactivates the cropping function	
			Off		
H Width		64–32768	Sets the layer's crop width		
V Height		64–32768	Sets the layer's crop height		
Initial X		-32768–32768	Sets the horizontal crop offset		
Initial Y		-32768–32768	Sets the vertical crop offset		
Opacity	0–100%	Sets the layer's transparency			
Input Settings	HDMI1	Mode	Standard	Uses standard resolution	
			Custom	Allows a custom resolution	
	HDMI2	EDID (Extended Display Identification Data)	Resolution (Standard)	1024 x 768	Standard EDID resolution. Available frame rates (Hz): 48, 50, 59.94, 60, 75, 85
				1280 x 720	Available frame rates (Hz): 23.98, 24, 25, 29.97, 30, 48, 50, 59.94, 60
				1280 x 1024	Available frame rates (Hz): 48, 50, 59.94, 60, 75, 85
				1366 x 768	Available frame rates (Hz): 50, 59.94, 60
				1440 x 900	Available frame rates (Hz): 60, 75, 85
				1600 x 1200	Available frame rates (Hz): 48, 50, 59.94, 60
				1680 x 1050	Available frame rates (Hz): 60
				1920 x 1080	Available frame rates (Hz): 23.98, 24, 25, 29.97, 30, 48, 50, 59.94, 60
				1920 x 1200	Available frame rates (Hz): 50, 59.94, 60
				1920 x 2160	Available frame rates (Hz): 23.98, 24, 25, 29.97, 30, 48, 50, 59.94, 60
				2048 x 1080	Available frame rates (Hz): 30, 48, 50, 59.94, 60
				2048 x 1152	Available frame rates (Hz): 30, 60
DVI1					
DVI2					

Main Level	Programming Levels		Description		
Input Settings (cont.)	HDMI1 (cont.) HDMI2 (cont.) DVI1 (cont.) DVI2 (cont.)	EDID (Extended Display Identification Data, cont.)	Resolution (Standard, cont.)		
			2560 x 1080	Available frame rates (Hz): 50, 59.94, 60	
			2560 x 1600	Available frame rates (Hz): 50, 59.94, 60	
			3840 x 1080	Available frame rates (Hz): 30, 50, 59.94, 60	
			3840 x 2160	Available frame rates (Hz): 30	
			Frame Rate (Hz) (Standard)	23.98	Preset EDID frame rate. Availability based on selected resolution.
				24	
				25	
				29.97	
				30	
				48	
				50	
				59.94	
				60	
			Width (Custom)	800–4092	Custom EDID resolution width. Range depends on height.
				Height (Custom)	600–3981
		Frame Rate (Hz) (Custom)	23.98	Custom EDID frame rate. Availability based on selected resolution.	
			24		
			25		
			29.97		
			30		
			47.95		
			48		
			50		
			59.94		
			60		
			72		
			75		
			85		
		100			
		120			
		Apply		Applies selected EDID settings	
Input Color	Brightness	0–100	Adjusts the input brightness		
	Contrast		Adjusts the input contrast		
	Saturation		Adjusts the input saturation		
	Hue	-180–180	Adjusts the input hue		
Reset		Resets the input color settings			
Color/Sample	RGB 4:4:4	Displays color space and sample rate of the input source			
Limited to Full	On	Activates/deactivates color range conversion from RGB Limited to RGB Full			
	Off				

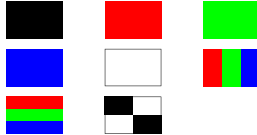
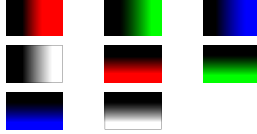
Main Level	Programming Levels				Description	
Input Settings (cont.)	SDI	Input Color	Brightness	0–100	Adjusts the input brightness	
			Contrast		Adjusts the input contrast	
			Saturation		Adjusts the input saturation	
			Hue	-180–180	Adjusts the input hue	
		Reset		Resets the input color settings		
	Color/Sample	YCbCr 4:2:2		Displays color space and sample rate of the input source		
	MOSAIC	Layout			Selects the MOSAIC layout orientation	
		Width	64–2048		Sets the width of the MOSAIC	
		Height	64–2048		Sets the height of the MOSAIC	
		Total Resolution X	----- -----	HDMI1	Selects HDMI MOSAIC and top or left input	
				HDMI2		
				DVI1	Selects DVI MOSAIC and top or left input	
				DVI2		
				OPT1-1	Selects optic MOSAIC and top or left input	
	Apply		Applies the selected MOSAIC settings			
Reset		Resets the MOSAIC settings to factory default				
Preset Settings	Preset 1–10	Save		Saves the current settings		
		Load		Loads saved preset settings		
		Clear	No	Clears the selected preset		
			Yes			
Copy To	Preset 1–10	Copies the selected preset to another preset slot				
Image Mosaic	Status	On		Activates/deactivates image mosaic function		
	Off					
	Total H Pixels	64–32768		Sets the total height in pixels		
	Total V Pixels	64–32768		Sets the total width in pixels		
	Load Area Width	64-----		Sets the output width of this VIP Drive 10-5 Nova in pixels (range based on Screen Configuration)		
	Load Area Height	64-----		Sets the output height of this VIP Drive 10-5 Nova in pixels (range based on Screen Configuration)		
	Load Area Initial X	0-----		Sets the horizontal offset of this product's output (range based on Load Area Width)		
	Load Area Initial Y	0-----		Sets the vertical offset of this product's output (range based on Load Area Height)		
Reset		Resets the Image Mosaic settings to factory default				
Display Control	Normal		Video playback mode			
	Freeze		Freezes on the current frame			
	FTB		Fades the output To Black			

Main Level	Programming Levels		Description	
Display Control (cont.)	Test Pattern	Pure Color		Tests the connected video product assembly with solid colors
		Gradient		Tests the connected video product assembly with gradient effects
		Grid		Tests the connected video product assembly with grid line effects
		Brightness	1-4	Sets the brightness of the test
		Spacing	1-8	Sets the test pattern spacing
		Speed	1-4	Sets grid line speed
	Main Layer Trans	Fade Cut	Fade or Cut between main layer input sources	
	Trans Duration (s)	0.5-2.0	Sets the duration of transition effects	
	FTB Duration (s)	0.0-2.0	Sets the duration of Fade To Black	
	Advanced Settings	Device Backup		Primary Backup Sets product as the primary device Sets product as the backup device
Input Backup		Status	On Off	Activates/deactivates input backup function
		HDMI1 ↔	N/A HDMI2	Selects backup input source for each input connector
			DVI1 ↔	
		MOSAIC(H) ↔		N/A MOSAIC(D)
			Reset	
Synchronization		Status: On, Off Source: Genlock, HDMI1, HDMI2, DVI1, DVI2, SDI, OPT1-1, OPT1-2 Enables/disables synchronization of cascaded products or primary and backup Selects the sync source		

Main Level	Programming Levels		Description	
Advanced Settings (cont.)	HDMI Output	Mode	Monitor	Selects monitor signal output
			Video Output	Selects video signal output
		Resolution	1024 x 768	Monitor resolution. Available frame rates (Hz): 48, 50, 59.94, 60, 75, 85
			1280 x 720	Available frame rates (Hz): 23.98, 24, 25, 29.97, 30, 48, 50, 59.94, 60
			1280 x 1024	Available frame rates (Hz): 48, 50, 59.94, 60, 75, 85
			1366 x 768	Available frame rates (Hz): 50, 59.94, 60
			1440 x 900	Available frame rates (Hz): 60, 75, 85
			1600 x 1200	Available frame rates (Hz): 48, 50, 59.94, 60
			1680 x 1050	Available frame rate (Hz): 60
			1920 x 1080	Available frame rates (Hz): 23.98, 24, 25, 29.97, 30, 48, 50, 59.94, 60
			1920 x 1200	Available frame rates (Hz): 50, 59.94, 60
		Frame Rate (Hz)	23.98	Monitor frame rate. Availability based on selected resolution.
			24	
			25	
			29.97	
	30			
	48			
	50			
	59.94			
	60			
	75			
	85			
	Apply		Applies the selected HDMI output settings	
	Audio	Output	Off	Turns off the audio
			Main Layer	Plays the audio from the selected source
			PIP1	
		PIP2		
Volume	0–100	Sets the audio volume		
Input HDCP	On	Enables/disables transmission and processing of HDCP-encrypted content		
	Off			
Low Latency	On	Enables/disables low latency function		
	Off			
3D	Status	On	Activates/deactivates 3D mode	
		Off		
	3D Format	Side-by-Side	Selects the format of the video source	
		Top-and-Bottom		
Frame Sequential				

Main Level	Programming Levels			Description		
Advanced Settings (cont.)	3D (cont.)	Eye Priority	Left	Selects the eye priority		
			Right			
		More Settings	Right Eye Start	0–8192	Sets the right eye offset	
			Signal Delay (µs)	0–20000	Sets the 3D signal delay timer (in microseconds)	
			Third-Party Emitter	Off	Disables/enables third-party emitter	
	On					
	OPT 2 Mode		Backup		Enables use of OPT 2 port as backup output port	
Copy			Copies the data flow of the connected fiber converter			
System Settings	FN		Synchronization		<FN> accesses the Synchronization menu	
			HDMI Output		<FN> accesses the HDMI Output menu	
			FTB		<FN> toggles Fade To Black	
	Return to Home (s)		30–3600		Sets Home Screen timeout	
	Diagnostics		No		Displays current diagnostic data	
			Yes			
			F_VERSION			-----
			F_CONNECT			--
			F_VCCINT			---.(V)
			F_VCCAUX			---.(V)
			F_VCCBRAM			---.(V)
			F_TEMP			---.(C)
			F_D_CLK_ST			--
			F_DISP_CLK			---.(MHz)
			F_M_CLK_ST			--
			F_MONT_CLK			---.(MHz)
			F_DDR			--
			F_MMCM_LK			--
			F_GTX_LK_ST0			--
			F_GTX_LK_FRE0			---.(MHz)
F_GTX_LK_ST1			--			
F_GTX_LK_FRE1			---.(MHz)			
A_MEM_PER			..(%)			
A_CPU_PER			..(%)			
A_EMMC_PER		..(%)				
M_VERSION		-----				
S_VERSION		-----				
H_VERSION		--				
H_TEMP_BD		---.(C)				
H_VCC_BD		---.(V)				
H_TEST_COUNT		--				
S0_TEMP		---.(C)				
S1_TEMP		---.(C)				
About	Firmware Version		---.---.---	Displays the firmware version		

Main Level	Programming Levels		Description		
Factory Reset	Reset (Save IP)	No	Resets the settings (except communication settings) to factory defaults		
		Yes			
	Partial Reset	No	Resets the settings (except for communication, FN, language settings, imported files, and device name) to factory default		
		Yes			
	Reset All	No	Resets all settings to factory default		
		Yes			
Communication	Mode	LAN Preferred		Sets Ethernet connection as priority	
		USB Preferred		Sets USB connection as priority	
	Mode	Automatic		Assigns IP address to the product automatically	
		Manual		Sets the IP address, gateway, and subnet mask manually	
	Network	IP Address	---:---:---:---		Displays/sets the product's IP address
		Subnet Mask	---:---:---:---		Displays/sets the product's subnet mask
		Gateway	---:---:---:---		Displays/sets the product's gateway
		Apply		Applies network settings	
	Reset	No		Resets network settings	
		Yes			
Working Mode	Video Controller		Sets the device as the main control for all video settings		
	Fiber Converter		Sets the device to process fiber optic video input to Ethernet output		
	ByPass		Deactivates video processing functions		
语言/ Language	English		Sets display language to English		
	中文		Sets display language to Chinese		

Operating Settings Configuration

Home Screen

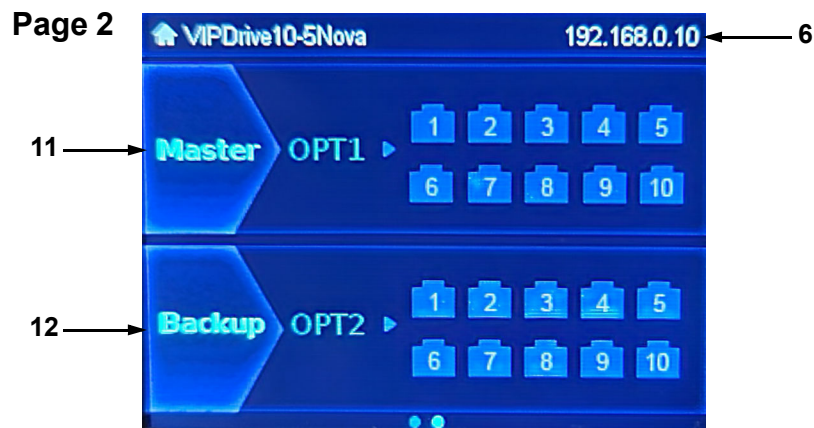
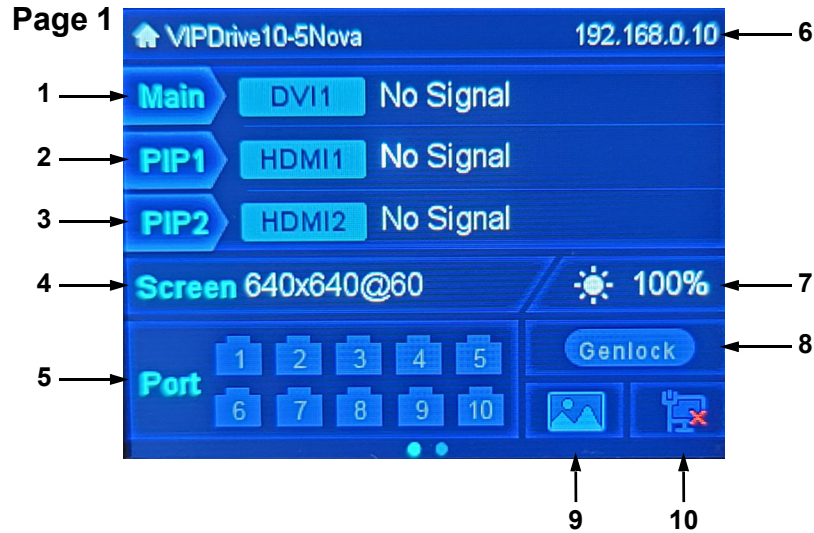

The VIP Drive 10-5 Nova has a home screen which displays the input signals, IP address, port statuses, and other operating settings.

- To see the home screen, press **<ESC>** repeatedly until it shows on the display.
- To access the main menu from the home screen, press the **<MENU>** knob.
- To view either page of the home screen, turn the **<MENU>** knob.
 1. Main layer. Displays the input signal assigned to this layer as well as the resolution and frame rate.
 2. PIP1 layer. Displays the input signal assigned to this layer as well as the resolution and frame rate.
 3. PIP2 layer. Displays the input signal assigned to this layer as well as the resolution and frame rate.
 4. Displays the output resolution and frame rate.
 5. Displays the status of each output port.
 6. Displays the IP address.
 7. Displays the output brightness.
 8. Displays the synchronization source and status.
 9. Displays the output status, from **Normal** (sample image), **FTB** (blank), **Freeze** (FRZ), or **Test Pattern** (vertical colored stripes).
 10. Displays the network/USB connection status.
 11. Displays the port status of the OPT1 signal.
 12. Displays the port status of the OPT2 signal.



When set to Fiber Converter mode, the home screen will change. See [Fiber Converter Menu](#) for more information.

Operation

Screen Brightness

The Brightness setting controls the total output level of the connected assembly.

1. Press the <MENU> knob to access the menu.
2. Turn the <MENU> knob until **Screen Brightness** is selected.
3. Press the <MENU> knob.
4. Turn the <MENU> knob to set the brightness from **0–100%**.
5. Press the <MENU> knob.

Screen Configuration

The Screen Configuration settings control the size of the connected video panel assembly, the ratio of panels to output port, the direction of the data flow, and the offset of the image, as well as panel firmware update options and output color temperature and frame rate.

To access the Screen Settings menu:

1. Press the <MENU> knob to access the menu.
2. Turn the <MENU> knob until **Screen Settings** is selected.
3. Press the <MENU> knob.

Quick Configuration

The Quick Configuration settings provide a simple method of controlling the size of the connected video panel assembly, the ratio of panels to output port, and the direction of the data flow. When using the Quick Configuration options, the number of video panels connected to ports 2 through 10 must be less than or equal to the number connected to port 1.

To access the Quick Configuration menu:

1. Access the [Screen Configuration](#) menu.
2. Turn the <MENU> knob until **Quick Configuration** is selected.
3. Press the <MENU> knob.

Cabinet Row Quantity

This setting defines the number of rows of panels (height) connected to the VIP Drive 10-5 Nova.

1. Access the [Quick Configuration](#) menu.
2. Turn the <MENU> knob until **Cabinet Row Qty** is selected.
3. Press the <MENU> knob.
4. Turn the <MENU> to set the number of rows, from **1–64**. (The highest number that can be selected is determined by the Column Quantity and the firmware of the connected panels.)
5. Press the <MENU> knob.

Cabinet Column Quantity

This setting defines the number of columns of panels (width) connected to the VIP Drive 10-5 Nova.

1. Access the [Quick Configuration](#) menu.
2. Turn the <MENU> knob until **Cabinet Column Qty** is selected.
3. Press the <MENU> knob.
4. Turn the <MENU> knob to set the number of columns, from **1–80**. (The highest number that can be selected is determined by the Row Quantity and the firmware of the connected panels.)
5. Press the <MENU> knob.

Port 1 Cabinet Quantity

This setting defines the number of panels connected to output port 1 of the VIP Drive 10-5 Nova.

1. Access the [Quick Configuration](#) menu.
2. Turn the <MENU> knob until **Port1 Cabinet Qty** is selected.
3. Press the <MENU> knob.
4. Turn the <MENU> knob to set the number of panels, from **1–46***. (The range of numbers that can be selected is determined by the Row and Column Quantities, and the firmware of the connected panels.)
5. Press the <MENU> knob.

In Quick Configuration, the number of panels connected to ports 2 through 10 may only be equal to or less than the number set to port 1.

For example: If there are 10 rows and 20 columns (200 total panels), port 1 can be set from 20–40. If port 1 is set to 40, ports 2 through 5 will output to 40 panels, and ports 6 through 10 will output to no panels (40+40+40+40+40 = 200). If port 1 is set to 20, all ports will output to 20 panels (20+20+20+20+20+20+20+20+20+20 = 200).

Port 1 will not be able to be set to any number lower than 20 because that is the lowest number that will allow port 10 to be equal to or less than port 1.

These numbers assume the default settings are available, and not overridden by the firmware of connected panels.



Data Flow

This setting addresses the panels in the connected assembly for all ports by selecting a starting point and a direction of flow, as seen from the front of the assembly.

1. Access the [Quick Configuration](#) menu.
2. Turn the <MENU> knob until **Data Flow (Front View)** is selected.
3. Press the <MENU> knob.
4. Turn the <MENU> knob to select from the following options:

Icon	Meaning	Icon	Meaning
	Starts at top left, goes all the way right, down by one, all the way left, down by one, and repeats.		Starts at bottom left, goes all the way right, up by one, all the way left, up by one, and repeats.
	Starts at top left, goes all the way down, right by one, all the way up, right by one, and repeats.		Starts at bottom left, goes all the way up, right by one, all the way down, right by one, and repeats.
	Starts at top right, goes all the way left, down by one, all the way right, down by one, and repeats.		Starts at bottom right, goes all the way left, up by one, all the way right, up by one, and repeats.
	Starts at top right, goes all the way down, left by one, all the way up, left by one, and repeats.		Starts at bottom right, goes all the way up, left by one, all the way down, left by one, and repeats.

5. Press the <MENU> knob.

Example Configuration

The following demonstrates how to set the Quick Configuration settings for a video panel configuration with 1 VIP Drive 10-5 Nova and 110 F2SQ video panels (168x168 pixels).

1. Set the [Cabinet Row Quantity](#) to 10.
2. Set the to [Cabinet Column Quantity](#) to 11.
3. Set the [Port 1 Cabinet Quantity](#) to 22. This will allow ports 1 through 5 to output to 2 complete rows each.
4. Set the [Data Flow](#) to the icon below, which (as viewed from the front) will start at the top left, go all the way to the right, down by one, all the way to the left, and down by one before repeating.



5. Connect the panels as in the diagram below:

As viewed from the back

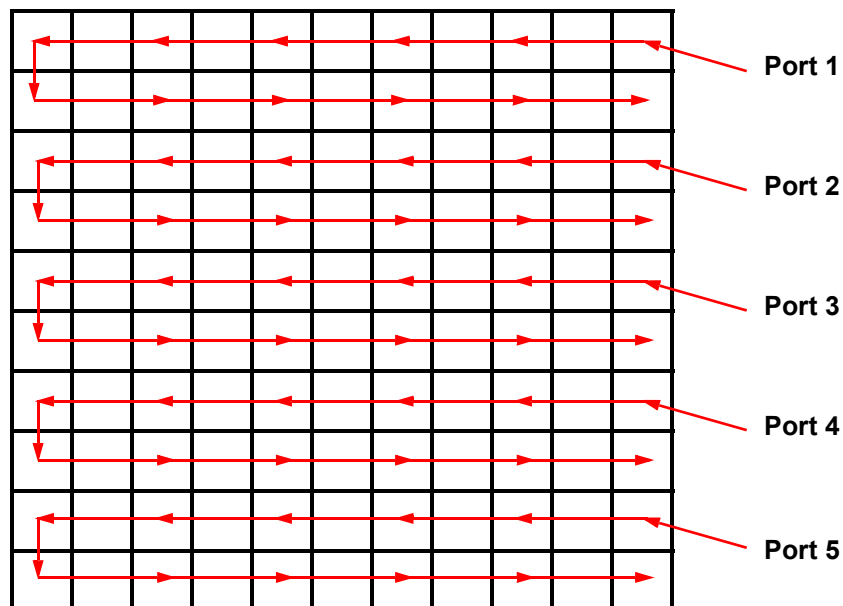

Operation

More Settings

The More Settings menu provides advanced configuration options and the mapping function, as well as options for setting the output color temperature, gamma, and frame rate.

To access the More Settings menu:

1. Access the [Screen Configuration](#) menu.
2. Turn the <MENU> knob until **More Settings** is selected.
3. Press the <MENU> knob.

Advanced Configuration

The Advanced Configuration settings provide a more in-depth method of controlling the size of the connected video panel assembly, the number of panels to output port, and the direction of the data flow for each port individually.

To access and enable the Advanced Configuration menu:

1. Access the [More Settings](#) menu.
2. Turn the <MENU> knob until **Advanced Configuration** is selected.
3. Press the <MENU> knob.
4. Turn the <MENU> knob to select from **No** (do not access) or **Yes** (access the menu).
5. Press the <MENU> knob.

To enable or disable Advanced Configuration:

1. Access the [Advanced Configuration](#) menu.
2. Turn the <MENU> knob until **Status** is selected.
3. Press the <MENU> knob.
4. Turn the <MENU> knob to select from **On** or **Off**.
5. Press the <MENU> knob.

Ethernet Port

To select which port to configure:

1. Access and enable the [Advanced Configuration](#) menu.
2. Turn the <MENU> knob to select **Ethernet Port**.
3. Press the <MENU> knob.
4. Turn the <MENU> knob to select the desired port, from **1–10**.
5. Press the <MENU> knob.

Cabinet Row Quantity

This setting defines the number of rows of panels (height) connected to the selected port.

1. Access and enable the [Advanced Configuration](#) menu.
2. Follow the instructions under [Ethernet Port](#) to select which port to configure.
3. Turn the <MENU> knob until **Cabinet Row Qty** is selected.
4. Press the <MENU> knob.
5. Turn the <MENU> knob to set the number of rows, from **1–40**. (The highest number that can be selected is determined by the Column Quantity of the selected port and the firmware of the connected panels.)
6. Press the <MENU> knob.

Cabinet Column Quantity

This setting defines the number of columns of panels (width) connected to the selected port.

1. Access and enable the [Advanced Configuration](#) menu.
2. Follow the instructions under [Ethernet Port](#) to select which port to configure.
3. Turn the <MENU> knob until **Cabinet Column Qty** is selected.
4. Press the <MENU> knob.
5. Turn the <MENU> knob to set the number of columns, from **1–40**. (The highest number that can be selected is determined by the Row Quantity of the selected port and the firmware of the connected panels.)
6. Press the <MENU> knob.

Horizontal Offset

This setting defines the horizontal placement of the panels connected to the selected port.

1. Access and enable the [Advanced Configuration](#) menu.
2. Follow the instructions under [Ethernet Port](#) to select which port to configure.
3. Turn the <MENU> knob until **Start X** is selected.
4. Press the <MENU> knob.
5. Turn the <MENU> knob to set the horizontal offset, from **0–10112**. (The highest number that can be selected is determined by the Column Quantity of the selected port and the firmware of the connected panels.)
6. Press the <MENU> knob.

Vertical Offset









This setting defines the vertical placement of the panels connected to the selected port.

1. Access and enable the [Advanced Configuration](#) menu.
2. Follow the instructions under [Ethernet Port](#) to select which port to configure.
3. Turn the <MENU> knob until **Start Y** is selected.
4. Press the <MENU> knob.
5. Turn the <MENU> knob to set the vertical offset, from **0–8064**. (The highest number that can be selected is determined by the Row Quantity of the selected port and the firmware of the connected panels.)
6. Press the <MENU> knob.

Data Flow

This setting addresses the panels connected to the selected port by selecting a starting point and a direction of flow, as seen from the front of the assembly.

1. Access and enable the [Advanced Configuration](#) menu.
2. Follow the instructions under [Ethernet Port](#) to select which port to configure.
3. Turn the <MENU> knob until **Data Flow (Front View)** is selected.
4. Press the <MENU> knob.
5. Turn the <MENU> knob to select from the following options:

Icon	Meaning	Icon	Meaning
	Starts at top left, goes all the way right, down by one, all the way left, down by one, and repeats.		Starts at bottom left, goes all the way right, up by one, all the way left, up by one, and repeats.
	Starts at top left, goes all the way down, right by one, all the way up, right by one, and repeats.		Starts at bottom left, goes all the way up, right by one, all the way down, right by one, and repeats.
	Starts at top right, goes all the way left, down by one, all the way right, down by one, and repeats.		Starts at bottom right, goes all the way left, up by one, all the way right, up by one, and repeats.
	Starts at top right, goes all the way down, left by one, all the way up, left by one, and repeats.		Starts at bottom right, goes all the way up, left by one, all the way down, left by one, and repeats.

6. Press the <MENU> knob.

Apply Advanced Configuration

The Advanced Configuration options are not fully set until the Apply option is selected. To apply the Advanced Configuration to the connected panel assembly:

1. Access and enable the [Advanced Configuration](#) menu.
2. Set all advanced configurations for each port as desired.
3. Turn the <MENU> knob to select **Apply**.
4. Press the <MENU> knob.

Reset Advanced Configuration

To reset the Advanced Configuration options to their default settings:

1. Access and enable the [Advanced Configuration](#) menu.
2. Turn the <MENU> knob to select **Reset**.
3. Press the <MENU> knob.

Mapping

To have every connected video product display its mapping address (port number and cabinet number):

1. Access the [More Settings](#) menu.
2. Turn the <MENU> knob until **Mapping** is selected.
3. Press the <MENU> knob.
4. Turn the <MENU> knob to select from **Off** (do not display addresses) or **Yes** (display addresses).
5. Press the <MENU> knob.

Operation

LED Screen Color

The LED Screen Color options set the gamma and color temperature of the overall output.

Gamma correction applies a non-linear function to the tonal ranges in the video before output, which balances the brightness and darkness of the resulting video. To set the gamma:

1. Access the [More Settings](#) menu.
2. Turn the <MENU> knob until **LED Screen Color** is selected.
3. Press the <MENU> knob.
4. Turn the <MENU> knob until **Gamma** is selected.
5. Press the <MENU> knob.
6. Turn the <MENU> knob to set the gamma, from **1.0–4.0**.
7. Press the <MENU> knob.

Color temperature refers to the overall warmth or coolness of the video display by defining maximum values for each LED color and adjusting their dimming curves to correspond. To select a preset color temperature:

1. Access the [More Settings](#) menu.
2. Turn the <MENU> knob until **LED Screen Color** is selected.
3. Press the <MENU> knob.
4. Turn the <MENU> knob until **Temperature** is selected.
5. Press the <MENU> knob.
6. Turn the <MENU> knob to select a preset, from **Standard, Cool, or Warm**.
7. Press the <MENU> knob.

To set a custom color temperature:

1. Access the [More Settings](#) menu.
2. Turn the <MENU> knob until **LED Screen Color** is selected.
3. Press the <MENU> knob.
4. Turn the <MENU> knob until **Temperature** is selected.
5. Press the <MENU> knob.
6. Turn the <MENU> knob to select **Custom**.
7. Press the <MENU> knob.
8. Turn the <MENU> knob to select which color value to alter, from **R** (red), **G** (green), or **B** (blue).
9. Press the <MENU> knob.
10. Turn the <MENU> knob to set the value of the selected color, from **000–255**.
11. Press the <MENU> knob.
12. Repeat steps 8-11 until the color temperature is set as desired.

Output Frame Rate

To set the frame rate of the output:

1. Access the [More Settings](#) menu.
2. Turn the <MENU> knob until **Output Frame Rate** is selected.
3. Press the <MENU> knob.
4. Turn the <MENU> knob to select the frame rate (in hertz), from **23.98, 24, 25, 29.97, 30, 47.95, 48, 50, 59.94, 60, 71.93, 72, 75, 85, 100, 119.88, or 120**.
5. Press the <MENU> knob.

Layer Settings

The Layer Settings determine which video input source is assigned to which output layer and in what way the layers are arranged in relation to each other.

- There are 3 layers: the Main Layer and 2 Picture In Picture layers.
- The Main Layer is capable of combining 2 HDMI input sources, 2 DVI input sources, or two optical input sources together into an input source called **Mosaic**.

To access the Layer Settings menu for each layer through the menu:

1. Press the <MENU> knob to access the menu.
2. Turn the <MENU> knob until **Layer Settings** is selected.
3. Press the <MENU> knob.
4. Turn the <MENU> knob to select the layer, from **Main Layer, PIP1, or PIP2**.
5. Press the <MENU> knob.

To access the Layer Settings for each layer through the buttons on the control panel:

- Press <MAIN> to access the **Main Layer** menu.
- Press <PIP1> to access the **PIP1** menu.
- Press <PIP2> to access the **PIP2** menu.



Pressing one of the above buttons to access the menu for that layer automatically sets the Status of that layer to On.

Layer Status

To activate or deactivate a layer:

1. Access the [Layer Settings](#) menu for the desired layer.
2. Turn the <MENU> knob until **Status** is selected.
3. Press the <MENU> knob.
4. Turn the <MENU> knob to select from **On** (activated) or **Off** (deactivated).
5. Press the <MENU> knob.

Input Source

To select the Input Source for each layer:

1. Access the [Layer Settings](#) menu for the desired layer.
2. Turn the <MENU> knob until **Input Source** is selected.
3. Press the <MENU> knob.
4. Turn the <MENU> knob to select the input source, from **HDMI1**, **HDMI2**, **DVI1**, **DVI2**, **SDI**, **OPT1-1**, **OPT1-2**, or **MOSAIC** (Main Layer only).
5. Press the <MENU> knob.



Only the Main Layer can use the MOSAIC input. When the MOSAIC input is in use, the PIP1 and PIP2 layers are disabled.

Scaling Mode

There are 3 Scaling Modes available for each layer:

- **Full Screen** scales the selected layer to the entire connected video product assembly.
- **Pixel to Pixel** scales the layer 1 to 1, without altering the aspect ratio of the input source.
- **Custom** allows the layer to be scaled manually by width, height and horizontal/vertical offsets.

To select the Scaling Mode:

1. Access the [Layer Settings](#) menu for the desired layer.
2. Turn the <MENU> knob until **Scaling Mode** is selected.
3. Press the <MENU> knob.
4. Turn the <MENU> knob to select the layer, from **Full Screen**, **Pixel to Pixel**, or **Custom**.
5. Press the <MENU> knob.

Custom Scaling Options

With the scaling mode set to Custom, the width, height, horizontal offset, and vertical offset options become available for the selected layer.

To scale a layer with custom values:

1. Access the [Layer Settings](#) menu for the desired layer.
2. Set the scaling mode for the selected layer to **Custom**.
3. Turn the <MENU> knob to select which value to alter, from:
 - **H Width** (sets the horizontal width of the layer, from **64–32768**),
 - **V Height** (sets the vertical height of the layer, from **64–32768**),
 - **Initial X** (sets the horizontal offset of the layer, from **-32768–32768**), or
 - **Initial Y** (sets the vertical offset of the layer, from **-32768–32768**).
4. Press the <MENU> knob.
5. Turn the <MENU> knob to set the selected value.
6. Press the <MENU> knob.
7. Repeat steps 3-6 until the layer is scaled as desired.

Layer Priority

When multiple layers occupy the same space on the connected video product assembly, the Priority setting determines which layer will appear over the other layers.

To set the priority for each layer:

1. Access the [Layer Settings](#) menu for the desired layer.
2. Turn the <MENU> knob until **Priority** is selected.
3. Press the <MENU> knob.
4. Turn the <MENU> knob to set the Priority, from **1–3**.
 - **3** is the highest priority. The layer set to **3** will appear over both other layers.
 - **2** is the middle priority. The layer set to **2** will appear over the layer set to **1**, but under the layer set to **3**.
 - **1** is the lowest priority. The layer set to **1** will appear under both other layers.
5. Press the <MENU> knob.

Operation

Layer Input Crop

The Input Crop function allows the edges of each layer to be trimmed so only the desired part of that layer is displayed. This function operates independently from the Scaling Mode.

To enable or disable Input Crop:

1. Access the [Layer Settings](#) menu for the desired layer.
2. Turn the <MENU> knob until **Input Crop** is selected.
3. Press the <MENU> knob.
4. Turn the <MENU> knob until **Status** is selected.
5. Press the <MENU> knob.
6. Turn the <MENU> knob to select from **On** (enabled) or **Off** (disabled).
7. Press the <MENU> knob.

To specify the size and location of the desired area within a layer:

1. Access the [Layer Settings](#) menu and the Input Crop function for the desired layer.
2. Enable Input Crop.
3. Turn the <MENU> knob to select which value to alter, from:
 - **H Width** (sets the horizontal width of the crop section, from **64–32768**),
 - **V Height** (sets the vertical height of the crop section, from **64–32768**),
 - **Initial X** (sets the horizontal offset of the crop section within the total layer, from **-32768–32768**),
 - or
 - **Initial Y** (sets the vertical offset of the crop section within the total layer, from **-32768–32768**).
4. Press the <MENU> knob.
5. Turn the <MENU> knob to set the selected value.
6. Press the <MENU> knob.
7. Repeat steps 3-6 until the layer is cropped as desired.

Layer Opacity

The Opacity setting determines how opaque or transparent the selected layer is. Lowering the Opacity of a higher priority layer allows lower priority layers to be visible through it.

To set the Opacity:

1. Access the [Layer Settings](#) menu for the desired layer.
2. Turn the <MENU> knob until **Opacity** is selected.
3. Press the <MENU> knob.
4. Turn the <MENU> knob to set the Opacity, from **0–100%**.

Input Settings

The Input Settings determine the resolution, frame rate, and color settings of each input source, as well as the arrangement and input sources of the MOSAIC input.

To access the Input Settings menu for each input:

1. Press the <MENU> knob to access the menu.
2. Turn the <MENU> knob until **Input Settings** is selected.
3. Press the <MENU> knob.
4. Turn the <MENU> knob to select which input to configure, from **HDMI1**, **HDMI2**, **DVI1**, **DVI2**, **SDI**, or **MOSAIC**.
5. Press the <MENU> knob.

HDMI and DVI EDID Settings

The individual HDMI and DVI inputs use EDID (Extended Display Identification Data) to communicate with the source of the video signals and set the input resolution and frame rate.

To select whether to use standard EDID resolutions and frame rates or to set custom values for both:

1. Access the [Input Settings](#) menu for an HDMI or DVI input.
2. Turn the <MENU> knob until **EDID** is selected.
3. Press the <MENU> knob.
4. Turn the <MENU> knob until **Mode** is selected.
5. Press the <MENU> knob.
6. Turn the <MENU> knob to select from **Standard** or **Custom**.
7. Press the <MENU> knob.

Standard EDID Resolution

To select a preset resolution (in Standard EDID Mode):

1. Access the [Input Settings](#) menu for an HDMI or DVI input.
2. Turn the <MENU> knob until **EDID** is selected.
3. Press the <MENU> knob.
4. With the Mode set to Standard, turn the <MENU> knob until **Resolution** is selected.
5. Press the <MENU> knob.
6. Turn the <MENU> knob to select a preset resolution, from **1024 x 768, 1280 x 720, 1280 x 1024, 1366 x 768, 1440 x 900, 1600 x 1200, 1680 x 1050, 1920 x 1080, 1920 x 1200, 1920 x 2160, 2048 x 1080, 2048 x 1152, 2560 x 1080, 2560 x 1600, 3840 x 1080, or 3840 x 2160.**
7. Press the <MENU> knob.

Standard EDID Frame Rate

To select a preset frame rate (In Standard EDID Mode):

1. Access the [Input Settings](#) menu for an HDMI or DVI input.
2. Turn the <MENU> knob until **EDID** is selected.
3. Press the <MENU> knob.
4. With the Mode set to Standard, turn the <MENU> knob until **Frame Rate (Hz)** is selected.
5. Press the <MENU> knob.
6. Turn the <MENU> knob to select a preset frame rate, from **23.98, 24, 25, 29.97, 30, 48, 50, 59.94, 60, 75, or 85.**
7. Press the <MENU> knob.

Which frame rates are available depends on the resolution selected. Consult the following table to see which preset frame rates are available for each preset resolution:

Resolution	Available Frame Rates (Hz)	Resolution	Available Frame Rates (Hz)
1024 x 768	48, 50, 59.94, 60, 75, 85	1920 x 1200	50, 59.94, 60
1280 x 720	23.98, 24, 25, 29.97, 30, 48, 50, 59.94, 60	1920 x 2160	23.98, 24, 25, 29.97, 30, 48, 50, 59.94, 60
1280 x 1024	48, 50, 59.94, 60, 75, 85	2048 x 1080	30, 48, 50, 59.94, 60
1366 x 768	50, 59.94, 60	2048 x 1152	30, 60
1440 x 900	60, 75, 85	2560 x 1080	50, 59.94, 60
1600 x 1200	48, 50, 59.94, 60	2560 x 1600	50, 59.94, 60
1680 x 1050	60	3840 x 1080	30, 50, 59.94, 60
1920 x 1080	23.98, 24, 25, 29.97, 30, 48, 50, 59.94, 60	3840 x 2160	30



The standard refresh rate is 60 Hz. The total port capacity changes in inverse proportion to this setting (lower resolution gives a higher total port capacity and vice versa).

Custom EDID Resolution

To set a custom resolution (in Custom EDID Mode):

1. Access the [Input Settings](#) menu for an HDMI or DVI input.
2. Turn the <MENU> knob until **EDID** is selected.
3. Press the <MENU> knob.
4. With the Mode set to Custom, turn the <MENU> knob to select from:
 - **Width** (range is from **800–4092**, depending on the Height value), or
 - **Height** (range is from **600–3981**, depending on the Width value).
5. Press the <MENU> knob.
6. Turn the <MENU> knob to set the selected value.
7. Press the <MENU> knob.
8. Repeat steps 4-7 until the layer is cropped as desired.

Operation

Custom EDID Frame Rate

To select the frame rate (in Custom EDID Mode):

1. Access the [Input Settings](#) menu for an HDMI or DVI input.
2. Turn the <MENU> knob until **EDID** is selected.
3. Press the <MENU> knob.
4. With the Mode set to Custom, turn the <MENU> knob until **Frame Rate (Hz)** is selected.
5. Press the <MENU> knob.
6. Turn the <MENU> knob to select the frame rate, from **23.98, 24, 25, 29.97, 30, 47.95, 48, 50, 59.94, 60, 72, 75, 85, 100**, or **120**.
7. Press the <MENU> knob.



Which frame rates are available depends on how the custom resolution is set.



The standard refresh rate is 60 Hz. The total port capacity changes in inverse proportion to this setting (lower resolution gives a higher total port capacity and vice versa).

Apply EDID Settings

The EDID resolution and frame rate are not fully set until the Apply option is selected. To ensure that the selected options are applied to the selected input:

1. Access the [Input Settings](#) menu for an HDMI or DVI input.
2. Turn the <MENU> knob until **EDID** is selected.
3. Press the <MENU> knob.
4. Set the EDID settings as desired.
5. Turn the <MENU> knob until **Apply** is selected.
6. Press the <MENU> knob.

Input Color Settings

The Input Color settings adjust how the VIP Drive 10-5 Nova processes the colors of the selected input.

- **Brightness** controls the overall brightness of the selected input.
- **Contrast** controls the separation of different colors in the selected input
- **Saturation** controls the intensity of all colors.
- **Hue** shifts the total color along a 360° spectrum. For example, at **-180**, green will be closer to blue, and red will be closer to orange, while at **180**, green will be closer to yellow, and red will be closer to pink.

To set the Input Color settings:

1. Access the [Input Settings](#) menu for an HDMI, DVI, or SDI input.
2. Turn the <MENU> knob until **Input Color** is selected.
3. Press the <MENU> knob.
4. Turn the <MENU> knob to select which setting to adjust, from **Brightness, Contrast, Saturation**, or **Hue**, or select **Reset** to reset these settings to their default values.
5. Press the <MENU> knob.
6. For:
 - **Brightness, Contrast, or Saturation**, turn the <MENU> knob to set the value, from **0–100**.
 - **Hue**, turn the <MENU> knob to set the color shift, from **-180–180**.
7. Press the <MENU> knob.
8. Repeat steps 4-7 until the Input Color settings for the selected input are set as desired.

Color Space/Sample Rate

To view the color space and sample rate of an input source:

1. Access the [Input Settings](#) menu for an HDMI, DVI, or SDI input.
2. Turn the <MENU> knob until **Color/Sample** is selected.
3. Press the <MENU> knob.

Convert Limited RGB to Full RGB

The VIP Drive 10-5 Nova is capable of processing Limited RGB HDMI and DVI signals to Full RGB output.

To enable or disable this function for an input source:

1. Access the [Input Settings](#) menu for an HDMI or DVI input.
2. Turn the <MENU> knob until **Limited to Full** is selected.
3. Press the <MENU> knob.
4. Turn the <MENU> knob to select from **Standard** or **Custom**.
5. Press the <MENU> knob.

Input MOSAIC

The input MOSAIC combines both HDMI inputs, both DVI inputs, or both optical inputs so they can share the main layer of the VIP Drive 10-5 Nova.



Only the Main Layer can use the input MOSAIC function. When the input MOSAIC function is in use, the PIP1 and PIP2 layers are disabled.

Input MOSAIC Layout

To select the orientation of the input MOSAIC:

1. Access the [Input Settings](#) menu for the MOSAIC input.
2. Turn the <MENU> knob until **Layout** is selected.
3. Press the <MENU> knob.
4. Turn the <MENU> knob to select from the following:



Top/Bottom

or

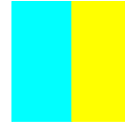

Left/Right

5. Press the <MENU> knob.

Input MOSAIC Dimensions

To set the width and height of both of the inputs used for the input MOSAIC:

1. Access the [Input Settings](#) menu for the MOSAIC input.
2. Turn the <MENU> knob to select **Width** or **Height**.
3. Press the <MENU> knob.
4. Turn the <MENU> knob to set the selected value, from **64–2048**.
5. Press the <MENU> knob.
6. Repeat steps 2-5 until the dimensions of both separate inputs are set as desired.



The Total Resolution line displays the combined Width and Height of both inputs according to the selected Layout.

Input MOSAIC Sources and Priority

To select which pair of input sources to use for the input MOSAIC, and which one of the two will appear on top or on the left:

1. Access the [Input Settings](#) menu for the MOSAIC input.
2. Turn the <MENU> knob until the **Total Resolution** line is selected.
3. Press the <MENU> knob.
4. Turn the <MENU> knob to select the top or left input, from:
 - **HDMI1** (the bottom or right input will be HDMI2),
 - **HDMI2** (the bottom or right input will be HDMI1),
 - **DVI1** (the bottom or right input will be DVI2),
 - **DVI2** (the bottom or right input will be DVI1),
 - **OPT1-1** (the bottom or right input will be OPT1-1), or
 - **OPT1-2** (the bottom or right input will be OPT1-1).
5. Press the <MENU> knob.

Apply Input MOSAIC Settings

The input MOSAIC is not fully configured until the Apply option is selected. To ensure that the selected options are applied to the input MOSAIC:

1. Access the [Input Settings](#) menu for the MOSAIC input.
2. Set the MOSAIC settings as desired.
3. Turn the <MENU> knob until **Apply** is selected.
4. Press the <MENU> knob.

Reset Input MOSAIC Settings

To reset the Input MOSAIC options to their default settings:

1. Access the [Input Settings](#) menu for the MOSAIC input.
2. Turn the <MENU> knob until **Reset** is selected.
3. Press the <MENU> knob.

Operation

Preset Settings

The VIP Drive 10-5 Nova can record the current settings configuration as 1 of 10 Presets, and load that configuration at will. To access the Preset Settings:

1. Press the **<MENU>** knob to access the menu.
2. Turn the **<MENU>** knob until **Preset Settings** is selected.
3. Press the **<MENU>** knob.



- **Preset slots with no data saved are marked Blank.**
- **Preset slots with saved configuration data are marked Saved.**
- **The currently loaded Preset slot is marked Used.**

Save Preset

To save the current configuration of settings to a Preset slot:

1. Access the [Preset Settings](#).
2. Turn the **<MENU>** knob to select the desired slot, from **Preset 1–10**.
3. Press the **<MENU>** knob.
4. Turn the **<MENU>** knob to select **Save**.
5. Press the **<MENU>** knob.
6. If a settings configuration has already been saved to that slot, the message **Overwrite Preset _?** will be displayed. Turn the **<MENU>** knob to select **No** or **Yes**.
7. Press the **<MENU>** knob.

Load Preset

To load the settings configuration of a saved Preset:

1. Access the [Preset Settings](#).
2. Turn the **<MENU>** knob to select the desired **Saved** slot, from **Preset 1–10**.
3. Press the **<MENU>** knob.
4. Turn the **<MENU>** knob to select **Load**.
5. Press the **<MENU>** knob.

Clear Preset

To clear a Preset slot, deleting all saved configuration data:

1. Access the [Preset Settings](#).
2. Turn the **<MENU>** knob to select the desired **Saved** slot, from **Preset 1–10**.
3. Press the **<MENU>** knob.
4. Turn the **<MENU>** knob to select **Clear**.
5. Press the **<MENU>** knob.
6. Turn the **<MENU>** knob to select **No** or **Yes**.
7. Press the **<MENU>** knob.

Copy Preset

To copy a Saved Preset to a Blank Preset slot:

1. Access the [Preset Settings](#).
2. Turn the **<MENU>** knob to select the desired **Saved** slot, from **Preset 1–10**.
3. Press the **<MENU>** knob.
4. Turn the **<MENU>** knob to select **Copy To**.
5. Press the **<MENU>** knob.
6. Turn the **<MENU>** knob to select the desired Preset slot, from **Preset 1–10**.
7. Press the **<MENU>** knob.
8. If a settings configuration has already been saved to that slot, the message **Overwrite Preset _?** will be displayed. Turn the **<MENU>** knob to select **No** or **Yes**.
9. Press the **<MENU>** knob.

Image Mosaic

The Image Mosaic function allows multiple VIP Drive 10-5 Nova products to work together to each display part of a whole, cohesive, video display on a shared connected video product assembly. This allows larger video product assemblies to be used than can be connected to a single VIP Drive 10-5 Nova.



The Image Mosaic function is not connected directly to the Input MOSAIC function.

To access the Image Mosaic menu:

1. Press the **<MENU>** knob to access the menu.
2. Turn the **<MENU>** knob until **Image Mosaic** is selected.
3. Press the **<MENU>** knob.

To enable or disable the Image Mosaic function:

1. Access the [Image Mosaic](#) menu.
2. Turn the **<MENU>** knob until **Status** is selected.
3. Press the **<MENU>** knob.
4. Turn the **<MENU>** knob to select from **On** or **Off**.
5. Press the **<MENU>** knob.

Total Image Mosaic Pixels

To define the total dimensions of the connected video product assembly in pixels:

1. Access the [Image Mosaic](#) menu and set the **Status** to **On**.
2. Turn the **<MENU>** knob to select the desired parameter, from **Total H Pixels** (Height) or **Total W Pixels** (Width).
3. Press the **<MENU>** knob.
4. Turn the **<MENU>** knob to set the selected parameter, from **64–32768**.
5. Press the **<MENU>** knob.
6. Repeat steps 2-5 until the dimensions are set as desired.

Load Area Dimensions

The Load Area is the size of the output of each individual VIP Drive 10-5 Nova within a given Image Mosaic.

To define the Load Area of the VIP Drive 10-5 Nova being configured:

1. Access the [Image Mosaic](#) menu and set the **Status** to **On**.
2. Turn the **<MENU>** knob to select the desired parameter, from **Load Area Width** or **Load Area Height**.
3. Press the **<MENU>** knob.
4. Turn the **<MENU>** knob to set the selected parameter, from **64–_____**. (available range depends on the [Screen Configuration](#).)
5. Press the **<MENU>** knob.
6. Repeat steps 2-5 until the Load Area is set as desired.

Load Area Offset

The offset defines the location of the Load Area within the total Image Mosaic.

To set the Load Area offset of the VIP Drive 10-5 Nova being configured:

1. Access the [Image Mosaic](#) menu and set the **Status** to **On**.
2. Turn the **<MENU>** knob to select the desired parameter, from **Load Area Initial X** (horizontal offset) or **Load Area Initial Y** (vertical offset).
3. Press the **<MENU>** knob.
4. Turn the **<MENU>** knob to set the selected parameter, from **0–_____** (the available range is 32,768 minus the relevant Load Area parameter).
5. Press the **<MENU>** knob.
6. Repeat steps 2-5 until the Load Area offset is set as desired.



Example: If the Load Area Width is set to 1920 and the Load Area Height is set to 1080, the maximum horizontal offset will be 30848 (32,768-1,920), and the maximum vertical offset will be 31688 (32,768-1,080).

Image Mosaic Reset

To reset the Image Mosaic options to the default settings:

1. Access the [Image Mosaic](#) menu and set the **Status** to **On**.
2. Turn the **<MENU>** knob until **Reset** is selected.
3. Press the **<MENU>** knob.

Operation

Display Control

The Display Control settings control the output on the connected video product assembly, including the output status, test patterns, color balance, and input transitions. To access the Display Control menu:

1. Press the **<MENU>** knob to access the menu.
2. Turn the **<MENU>** knob until **Display Control** is selected.
3. Press the **<MENU>** knob.

Output Status

To toggle between video output, freezing on 1 image, and fading to black:























1. Access the [Display Control](#) menu.
2. Turn the **<MENU>** knob to select the display mode from **Normal**, **Freeze**, or **FTB** (Fade To Black).
3. Press the **<MENU>** knob.

Test Pattern

The VIP Drive 10-5 Nova can use solid colors, gradients, and moving grid line test patterns to test the functionality of all connected video products.

To select a test pattern to display:

1. Access the [Display Control](#) menu.
2. Turn the **<MENU>** knob until **Test Pattern** is selected.
3. Press the **<MENU>** knob.
4. Turn the **<MENU>** knob to select the type of test pattern, from **Pure Color**, **Gradient**, or **Grid**.
5. Press the **<MENU>** knob.
6. Turn the **<MENU>** knob to select the test pattern, from:

Icon	Meaning	Icon	Meaning
	Pure Color: black		Gradient: horizontal black to red
	Pure Color: red		Gradient: horizontal black to green
	Pure Color: green		Gradient: horizontal black to blue
	Pure Color: blue		Gradient: horizontal black to white
	Pure Color: white		Gradient: vertical black to red
	Pure Color: vertical stripes		Gradient: vertical black to green
	Pure Color: horizontal stripes		Gradient: vertical black to blue
	Pure Color: black and white squares		Gradient: vertical black to white
	Grid: horizontal lines		Grid: vertical lines
	Grid: forward diagonal lines		Grid: backward diagonal lines
	Grid: horizontal and vertical lines		Grid: backwards and forwards diagonal lines

7. Press the **<MENU>** knob.

Test Pattern Brightness

To set the brightness of the test pattern:

1. Access the [Display Control](#) menu.
2. Turn the **<MENU>** knob until **Test Pattern** is selected.
3. Press the **<MENU>** knob.
4. Turn the **<MENU>** knob until **Brightness** is selected.
5. Press the **<MENU>** knob.
6. Turn the **<MENU>** knob to set the brightness, from **1–4**.
7. Press the **<MENU>** knob.

Test Pattern Spacing

Each test pattern except for the single-color Pure Color patterns will repeat itself to fill the connected video product assembly. The Spacing setting determines the size of each repetition or the space between grid lines. To set the spacing of all Test Pattern output:

1. Access the [Display Control](#) menu.
2. Turn the <MENU> knob until **Test Pattern** is selected.
3. Press the <MENU> knob.
4. Turn the <MENU> knob until **Spacing** is selected.
5. Press the <MENU> knob.
6. Turn the <MENU> knob to set the spacing, from **1–8**.
7. Press the <MENU> knob.

Test Pattern Speed

To set the speed of the Test Pattern Grid lines:

1. Access the [Display Control](#) menu.
2. Turn the <MENU> knob until **Test Pattern** is selected.
3. Press the <MENU> knob.
4. Turn the <MENU> knob until **Speed** is selected.
5. Press the <MENU> knob.
6. Turn the <MENU> knob to set the speed, from **1–4**.
7. Press the <MENU> knob.

Main Layer Transition

When switching between input sources in the Main Layer, there are 2 options for the transition effect.

- **Fade:** the video fades from one input source to the other.
- **Cut:** no transition effect, the video switches immediately to the new input source.

To select the transition effect:

1. Access the [Display Control](#) menu.
2. Turn the <MENU> knob until **Test Pattern** is selected.
3. Press the <MENU> knob.
4. Turn the <MENU> knob until **Main Layer Trans** is selected.
5. Press the <MENU> knob.
6. Turn the <MENU> knob to select the transition effect, from **Fade** or **Cut**.
7. Press the <MENU> knob.

Transition Duration

To set the amount of time it takes to switch between input sources:

1. Access the [Display Control](#) menu.
2. Turn the <MENU> knob until **Test Pattern** is selected.
3. Press the <MENU> knob.
4. Turn the <MENU> knob until **Trans Duration (s)** is selected.
5. Press the <MENU> knob.
6. Turn the <MENU> knob to set the transition duration, from **0.5–2.0** (seconds).
7. Press the <MENU> knob.

Fade To Black Duration

To set the speed of the Fade To Black effect:

1. Access the [Display Control](#) menu.
2. Turn the <MENU> knob until **Test Pattern** is selected.
3. Press the <MENU> knob.
4. Turn the <MENU> knob until **FTB Duration (s)** is selected.
5. Press the <MENU> knob.
6. Turn the <MENU> knob to set the transition duration, from **0.0–2.0** (seconds).
7. Press the <MENU> knob.

Operation

Advanced Settings

The Advanced Settings include functions such as backup, synchronization, monitor output, audio playback, 3D compatibility, and more. To access the Advanced Settings menu:

1. Press the <MENU> knob to access the menu.
2. Turn the <MENU> knob until **Advanced Settings** is selected.
3. Press the <MENU> knob.

Device Backup

A VIP Drive 10-5 Nova can be designated as a primary driver or as a backup driver.



- **The mapping of the backup driver must be identical to the primary driver.**
- **Each port of the backup driver must be connected to the last panel of the primary driver's equivalent port's chain.**

To set whether a VIP Drive 10-5 Nova is a primary driver or a backup driver:

1. Access the [Advanced Settings](#) menu.
2. Turn the <MENU> knob until **Device Backup** is selected.
3. Press the <MENU> knob.
4. Turn the <MENU> knob to select from **Primary** or **Backup**.
5. Press the <MENU> knob.

Device Backup example

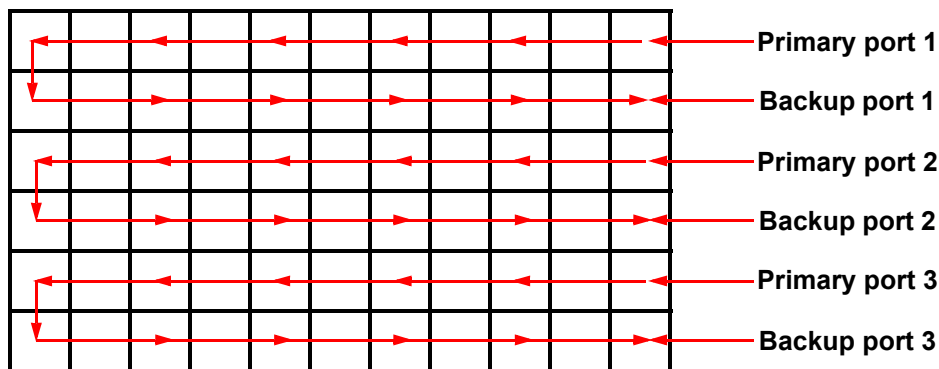

Input Backup

The Input Backup options assign a backup video source to each video source.

To enable or disable Input Backup:

1. Access the [Advanced Settings](#) menu.
2. Turn the <MENU> knob until **Input Backup** is selected.
3. Press the <MENU> knob.
4. Turn the <MENU> knob until **Status** is selected.
5. Press the <MENU> knob.
6. Turn the <MENU> knob to select from **On** or **Off**.
7. Press the <MENU> knob.

To select the backup for each input:

1. Access the [Advanced Settings](#) menu.
2. Turn the <MENU> knob until **Inputs Backup** is selected.
3. Press the <MENU> knob.
4. Turn the <MENU> knob to select from **HDMI1**, **DVI1**, or **MOSAIC(H)** (HDMI MOSAIC), or select **Reset** to reset the Input Backup options to the default settings.
 - **HDMI1** sets the backup for HDMI 1 to **N/A** (no backup), or **HDMI2**.
 - **DVI1** sets the backup for DVI1 to **N/A** (no backup), or **DVI2**.
 - **MOSAIC(H)** sets the backup for HDMI MOSAIC to **N/A** (no backup), or **MOSAIC(D)** (DVI MOSAIC).
5. Press the <MENU> knob.
6. Turn the <MENU> knob to select the backup for the selected input.
7. Press the <MENU> knob.
8. Repeat steps 4-7 until the backups are set as desired.

Synchronization

Synchronization keeps all connected products, including drivers, video products, cameras, and more, properly synchronized to each other. This helps to prevent glitches such as flickering in a camera feed, and ensures the Image Mosaic function integrates smoothly.

To enable or disable synchronization:

1. Access the [Advanced Settings](#) menu.
2. Turn the <MENU> knob until **Synchronization** is selected.
3. Press the <MENU> knob.
4. Turn the <MENU> knob until **Status** is selected.
5. Press the <MENU> knob.
6. Turn the <MENU> knob to select from **On** or **Off**.
7. Press the <MENU> knob.

To select the synchronization source:

1. Access the [Advanced Settings](#) menu.
2. Turn the <MENU> knob until **Synchronization** is selected.
3. Press the <MENU> knob.
4. Turn the <MENU> knob until **Source** is selected.
5. Press the <MENU> knob.
6. Turn the <MENU> knob to select the synchronization source, from **Genlock, HDMI1, HDMI2, DVI1, DVI2, SDI, OPT1-1, or OPT1-2**.
7. Press the <MENU> knob.

HDMI Output

The HDMI Output options configure the HDMI 1.3 port for use as a monitor output or video output.

To access the HDMI Output menu:

1. Access the [Advanced Settings](#) menu.
2. Turn the <MENU> knob until **HDMI Output** is selected.
3. Press the <MENU> knob.

HDMI Output Mode

To select the mode of the HDMI Output:

1. Access the [HDMI Output](#) menu.
2. Turn the <MENU> knob until **Mode** is selected.
3. Press the <MENU> knob.
4. Turn the <MENU> knob to select from **Monitor** or **Video Output**.
5. Press the <MENU> knob.

HDMI Output Resolution

To select the resolution of the HDMI 1.3 output:

1. Access the [HDMI Output](#) menu.
2. Turn the <MENU> knob until **Resolution** is selected.
3. Press the <MENU> knob.
4. Turn the <MENU> knob to select the resolution, from **1024 x 768, 1280 x 720, 1280 x 1024, 1366 x 768, 1440 x 900, 1600 x 1200, 1680 x 1050, 1920 x 1080, or 1920 x 1200**.
5. Press the <MENU> knob.

HDMI Output Frame Rate

To select the frame rate of the HDMI 1.3 output:

1. Access the [HDMI Output](#) menu.
2. Turn the <MENU> knob until **Resolution** is selected.
3. Press the <MENU> knob.
4. Turn the <MENU> knob to select the resolution, from **23.98, 24, 25, 29.97, 30, 48, 50, 59.94, 60, 75, or 85**.
5. Press the <MENU> knob.

Consult the following table to see which frame rates are available for each resolution:

Resolution	Available Frame Rates (Hz)	Resolution	Available Frame Rates (Hz)
1024 x 768	48, 50, 59.94, 60, 75, 85	1600 x 1200	48, 50, 59.94, 60
1280 x 720	23.98, 24, 25, 29.97, 30, 48, 50, 59.94, 60	1680 x 1050	60
1280 x 1024	48, 50, 59.94, 60, 75, 85	1920 x 1080	23.98, 24, 25, 29.97, 30, 48, 50, 59.94, 60
1366 x 768	50, 59.94, 60	1920 x 1200	50, 59.94, 60
1440 x 900	60, 75, 85		

Operation

Apply HDMI Output Settings

The HDMI 1.3 output is not fully configured until the Apply option is selected. To ensure that the selected options are applied to the input HDMI 1.3 output:

1. Access the [HDMI Output](#) menu.
2. Turn the <MENU> knob until **Apply** is selected.
3. Press the <MENU> knob.

Audio Settings

RJ45 outputs 1 and 2 support audio transmission, so multifunction cards can parse both the video and audio tracks of input sources.

To select which layer's input source will output audio:

1. Access the [Advanced Settings](#) menu.
2. Turn the <MENU> knob until **Audio** is selected.
3. Press the <MENU> knob.
4. Turn the <MENU> knob until **Output** is selected.
5. Press the <MENU> knob.
6. Turn the <MENU> knob to select the layer, from **Off** (no audio output), **Main Layer**, **PIP1**, or **PIP2**.
7. Press the <MENU> knob.

To set the volume of the audio output:

1. Access the [Advanced Settings](#) menu.
2. Turn the <MENU> knob until **Audio** is selected.
3. Press the <MENU> knob.
4. Turn the <MENU> knob until **Volume** is selected.
5. Press the <MENU> knob.
6. Turn the <MENU> knob to set the volume, from **0–100**.
7. Press the <MENU> knob.

Input High-Bandwidth Digital Content Protection

The VIP Drive 10-5 Nova is capable of processing input signals encrypted with HDCP.

To enable or disable this function:

1. Access the [Advanced Settings](#) menu.
2. Turn the <MENU> knob until **Input HDCP** is selected.
3. Press the <MENU> knob.
4. Turn the <MENU> knob to select from **On** or **Off**.
5. Press the <MENU> knob.

Latency Reduction

The Low Latency function reduces the latency inherent in running a signal through multiple devices via lengthy cables. When Low Latency is enabled and the products involved are all synchronized to the same source as the VIP Drive 10-5 Nova (see [Synchronization](#)), delays caused by latency can be reduced as low as a single frame.

To enable or disable Low Latency:

1. Access the [Advanced Settings](#) menu.
2. Turn the <MENU> knob until **Low Latency** is selected.
3. Press the <MENU> knob.
4. Turn the <MENU> knob to select from **On** or **Off**.
5. Press the <MENU> knob.

3D Mode

The VIP Drive 10-5 Nova can work with an external active shutter 3D system to output stereoscopic visuals. An active shutter system connected to and synchronized with the VIP Drive 10-5 Nova will control the shutter timing of compatible 3D glasses (when they switch between occluding the left or right eye), which renders the video displayed by the VIP Drive 10-5 Nova into 3D.



- **Because active shutter 3D technology requires double the frame rate to render a proper 3D display, the output capacity of the VIP Drive 10-5 Nova will be halved when 3D mode is active.**
- **The layer width or height may need to be halved, depending on the 3D Format setting.**

To access the 3D mode menu:

1. Access the [Advanced Settings](#) menu.
2. Turn the <MENU> knob until **3D** is selected.
3. Press the <MENU> knob.

To enable or disable 3D mode:

1. Access the [3D Mode](#) menu.
2. Turn the <MENU> knob until **Status** is selected.
3. Press the <MENU> knob.
4. Turn the <MENU> knob to select from **On** or **Off**.
5. Press the <MENU> knob.

3D Format

The 3D Format determines whether the alternating frames for either eye will be split in half and displayed Side-by-Side or Top-and-Bottom, or if they will display one after the other in Frame Sequential format.

- **Side-by-Side:** The display will be split vertically, with the left eye image on the left and the right eye image on the right. The **Width** of the layer will need to be half of the input source resolution width.
- **Top-and-Bottom:** The display will be split horizontally, with the left eye image on the top and the right eye image on the bottom. The **Height** of the layer will need to be half of the input source resolution height.
- **Frame Sequential:** The left eye image and right eye image will display one after the other.

To select the 3D Format:

1. Access the [3D Mode](#) menu.
2. Turn the <MENU> knob until **3D Format** is selected.
3. Press the <MENU> knob.
4. Turn the <MENU> knob to select the format, from **Side-by-Side**, **Top-and-Bottom**, or **Frame Sequential**.
5. Press the <MENU> knob.

Eye Priority

To select the Eye Priority of the 3D display:

1. Access the [3D Mode](#) menu.
2. Turn the <MENU> knob until **Eye Priority** is selected.
3. Press the <MENU> knob.
4. Turn the <MENU> knob to select from **Left** or **Right**.
5. Press the <MENU> knob.

Right Eye Start

To set the offset of the right eye frames:

1. Access the [3D Mode](#) menu.
2. Turn the <MENU> knob until **More Settings** is selected.
3. Press the <MENU> knob.
4. Turn the <MENU> knob until **Right Eye Start** is selected.
5. Press the <MENU> knob.
6. Turn the <MENU> knob to set the offset, from **0–8192**.
7. Press the <MENU> knob.

Signal Delay

To set the Signal Delay:

1. Access the [3D Mode](#) menu.
2. Turn the <MENU> knob until **More Settings** is selected.
3. Press the <MENU> knob.
4. Turn the <MENU> knob until **Signal Delay (µs)** is selected.
5. Press the <MENU> knob.
6. Turn the <MENU> knob to set the delay, from **0–20000** (microseconds).
7. Press the <MENU> knob.

Operation

Third-Party Emitter

The Third-Party Emitter option allows the VIP Drive 10-5 Nova to work with 3D emitters made by companies other than Novastar or Chauvet. To enable or disable the use of third-party emitters:

1. Access the [3D Mode](#) menu.
2. Turn the <MENU> knob until **More Settings** is selected.
3. Press the <MENU> knob.
4. Turn the <MENU> knob until **Third-Party Emitter** is selected.
5. Press the <MENU> knob.
6. Turn the <MENU> knob to select from **Off** or **On**.
7. Press the <MENU> knob.

OPT 2 Mode

The OPT 2 Mode setting defines the function of the OPT 2 SFP port.

- **Backup**: sends a backup signal to a VIP Drive 10-5 Nova connected to the same video product assembly.
- **Copy**: sends the output data to a VIP Drive 10-5 Nova connected to a separate video product assembly at distance.

To select the OPT 2 Mode:

1. Access the [Advanced Settings](#) menu.
2. Turn the <MENU> knob until **OPT 2 Mode** is selected.
3. Press the <MENU> knob.
4. Turn the <MENU> knob to select from **Backup** or **Copy**.
5. Press the <MENU> knob.

System Settings

The System Settings include the shortcut button, home screen timeout, and the system diagnostic function. To access the System Settings menu:

1. Press the <MENU> knob to access the menu.
2. Turn the <MENU> knob until **System Settings** is selected.
3. Press the <MENU> knob.

Shortcut Button <FN>

The shortcut button <FN> can be set to perform 1 of 3 actions, either accessing the [Synchronization](#) menu, accessing the [HDMI Output](#) menu, or triggering the Fade To Black (FTB) function (see [Output Status](#)).

To set the function of <FN>:

1. Access the [System Settings](#) menu.
2. Turn the <MENU> knob until **FN** is selected.
3. Press the <MENU> knob.
4. Turn the <MENU> knob to select from **Synchronization**, **HDMI Output**, or **FTB**.
5. Press the <MENU> knob.

Home Screen Timeout

To set how long the display can stay inactive before automatically returning to the home screen:

1. Access the [System Settings](#) menu.
2. Turn the <MENU> knob until **Return to Home (s)** is selected.
3. Press the <MENU> knob.
4. Turn the <MENU> knob clockwise or counterclockwise to increase or decrease the time from **30–3600** (seconds).
5. Press the <MENU> knob.

Diagnostics

To run a system diagnostic and view a list of all driver versions as well as the status of all drivers and sensors:

1. Access the [System Settings](#) menu.
2. Turn the <MENU> knob until **Diagnostic** is selected.
3. Press the <MENU> knob.
4. Turn the <MENU> knob to select from **No** (do not run diagnostic) or **Yes** (run diagnostic).
5. Press the <MENU> knob.



- **Running a diagnostic will temporarily disrupt the product output.**
- **In the case of error or other malfunction, send the diagnostic results to Chauvet technical support (see [Contact Us](#)).**

Firmware Version

To see the current firmware version:

1. Access the [System Settings](#) menu.
2. Turn the <MENU> knob until **About** is selected.
3. Press the <MENU> knob.

Factory Reset

There are 3 options for resetting the VIP Drive 10-5 Nova to factory defaults:

- **Reset (Save IP):** Resets all settings except for the [Communication](#) menu.
- **Partial Reset:** Resets all settings except for [Communication](#), [Shortcut Button <FN>](#), [语言/ Language](#), any imported files, and the device name.
- **Reset All:** Resets the entire product.

To reset the product to factory defaults:

1. Press the <MENU> knob to access the menu.
2. Turn the <MENU> knob until **Factory Reset** is selected.
3. Press the <MENU> knob.
4. Turn the <MENU> knob to select from **Reset (Save IP)**, **Partial Reset**, or **Reset All**.
5. Press the <MENU> knob.
6. Turn the <MENU> knob to select from **No** (do not reset) or **Yes** (reset).
7. Press the <MENU> knob.

Communication

The Communication settings control the data connections and network addressing of the product.

To access the Communication menu:

1. Press the <MENU> knob to access the menu.
2. Turn the <MENU> knob until **Communication** is selected.
3. Press the <MENU> knob.

Communication Mode

This setting controls which data connection has priority.

1. Access the [Communication](#) menu.
2. Turn the <MENU> knob until **Mode** is selected.
3. Press the <MENU> knob.
4. Turn the <MENU> knob to select from **LAN Preferred** (ethernet connection will have priority) or **USB Preferred** (USB connection will have priority).
5. Press the <MENU> knob.

Network

These settings control the IP Address, Subnet Mask, and Gateway, either manually or automatically.

To access the Network menu:

1. Access the [Communication](#) menu.
2. Turn the <MENU> knob until **Network** is selected.
3. Press the <MENU> knob.

Network Mode

To switch between Automatic and Manual mode:

1. Access the [Network](#) menu.
2. Turn the <MENU> knob until **Mode** is selected.
3. Press the <MENU> knob.
4. Turn the <MENU> knob to select from **Automatic** (automatically set the IP address and subnet mask) or **Manual** (manually set the IP address and subnet mask).
5. Press the <MENU> knob.

IP Address

The values of the VIP Drive 10-5 Nova IP address have the following ranges:

1: **0–223**, 2: **0–255**, 3: **0–255**, 4: **1–255**. These ranges may vary depending on the other network settings.

To manually set the IP address (having set the [Network Mode](#) to **Manual**):

1. Access the [Network](#) menu.
2. Turn the <MENU> knob until **IP Address** is selected.
3. Press the <MENU> knob.
4. Turn the <MENU> knob to set the selected value.
5. Press the <MENU> knob to enter the selected value and cycle to the next value.
6. Repeat steps 4 and 5 until the IP Address is set as desired.
7. Press <ESC> to finish.

Operation

Subnet Mask

The values of the VIP Drive 10-5 Nova Subnet Mask have the following ranges:

1: **255**, 2: **0–255**, 3: **0–255**, 4: **0–255**.

To manually set the subnet mask (having set the [Network Mode](#) to **Manual**):

1. Access the [Network](#) menu.
2. Turn the **<MENU>** knob until **Subnet Mask** is selected.
3. Press the **<MENU>** knob.
4. Turn the **<MENU>** knob to set the selected value.
5. Press the **<MENU>** knob to enter the selected value and cycle to the next value.
6. Repeat steps 4 and 5 until the Subnet Mask is set as desired.
7. Press **<ESC>** to finish.

Gateway

To manually set the Gateway (having set the [Network Mode](#) to **Manual**):

1. Access the [Network](#) menu.
2. Turn the **<MENU>** knob until **Gateway** is selected.
3. Press the **<MENU>** knob.
4. Turn the **<MENU>** knob to set the selected value, from **0–255**.
5. Press the **<MENU>** knob to enter the selected value and cycle to the next value.
6. Repeat steps 4 and 5 until the Gateway is set as desired.
7. Press **<ESC>** to finish.

Apply Network Settings

The Network settings are not fully configured until the Apply option is selected. To ensure that the selected options are applied to the Network settings:

1. Access the [Network](#) menu.
2. Turn the **<MENU>** knob until **Apply** is selected.
3. Press the **<MENU>** knob.

Reset Network Settings

To reset the IP Address, Subnet Mask, and Gateway to default:

1. Access the [Network](#) menu.
2. Turn the **<MENU>** knob until **Reset** is selected.
3. Press the **<MENU>** knob.
4. Turn the **<MENU>** knob to select from **No** (do not reset) or **Yes** (reset).
5. Press the **<MENU>** knob.

Working Mode

This setting allows one VIP Drive 10-5 Nova to control another at distance via a fiber optic connection.

- The **Video Controller** option sets the product to process SDI, DVI, HDMI, and fiber optic input signals and convert them and the control data to fiber optic output or direct ethernet output for the connected assembly. In this mode the product acts as the controller.
- The **Fiber Converter** option converts fiber optic data to ethernet output for the connected assembly. In this mode the product acts as a receiver to relay the signal from the Video Controller product to the connected assembly.
- The **ByPass** option disables all video processing functions and outputs the unprocessed input sources to the connected video product assembly in a single layer.

To select the working mode:

1. Press the **<MENU>** knob to access the menu.
2. Turn the **<MENU>** knob until **Working Mode** is selected.
3. Press the **<MENU>** knob.
4. Turn the **<MENU>** knob to select **Video Controller**, **Fiber Converter**, or **ByPass**.
5. Press the **<MENU>** knob.
6. If **ByPass** was selected, turn the **<MENU>** knob to select from **No** (cancel) or **Yes** (enable).
7. Press the **<MENU>** knob.

Fiber Converter Menu

In **Fiber Converter** mode, the menu of the VIP Drive 10-5 Nova is limited to [Communication](#), [Working Mode](#), and [语言/Language](#). The home screen will also change to reflect the mode:

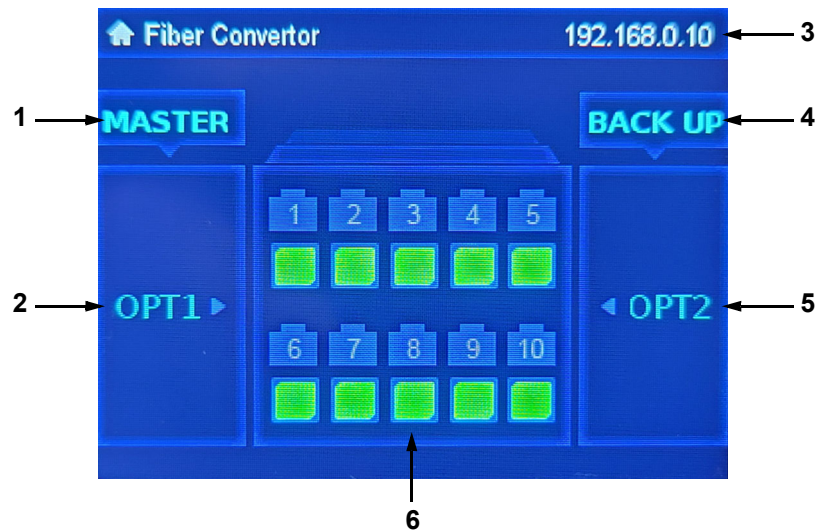

1. Labels the OPT1 port as MASTER.
2. Indicates the status of the OPT1 port.
3. Displays the IP address.
4. Labels the OPT2 port as BACKUP.
5. Indicates the status of the OPT2 port.
6. Indicates the status of each RJ45 output port.

语言/Language

The display menu of the VIP Drive 10-5 Nova can be set to display in either English or simplified Chinese.

1. Press the **<MENU>** knob to access the menu.
2. Turn the **<MENU>** knob until **语言/Language** is selected.
3. Press the **<MENU>** knob.
4. Turn the **<MENU>** knob to select from **English** or **中文** (Chinese).
5. Press the **<MENU>** knob.

Operation

NovaLCT Software

The VIP Drive 10-5 Nova and connected products can be configured by a computer running the NovaLCT software, through a USB or ethernet connection. Download the NovaLCT software for Windows computers from www.novastar.tech/downloads.

A User Manual with more information on the functions of NovaLCT is available from the same website.

Software Setup

To install and access all functions of the NovaLCT software:

1. Download the NovaLCT software from www.novastar.tech/downloads.
2. Run the setup file.
3. After installing the application and all included drivers, connect the VIP Drive 10-5 Nova and run the software.
4. Click **User (U)** in the menu running across the top of the window to open the drop-down menu.

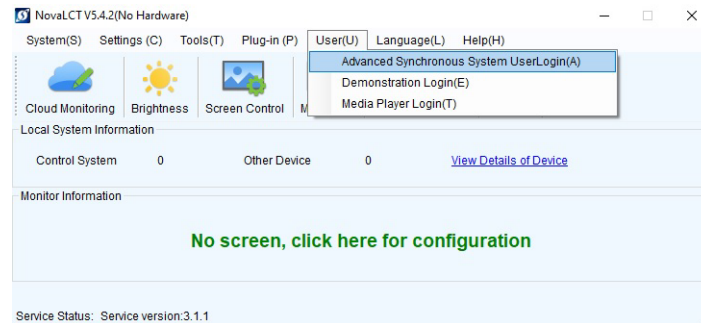

5. Click **Advanced Synchronous System UserLogin(A)**.

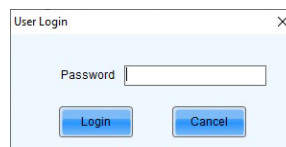

6. Type **admin** into the password field, and press the **Login** button on the screen, or press the **Enter** key.



Connect the VIP Drive 10-5 Nova to the computer before running NovaLCT.

Screen Configuration

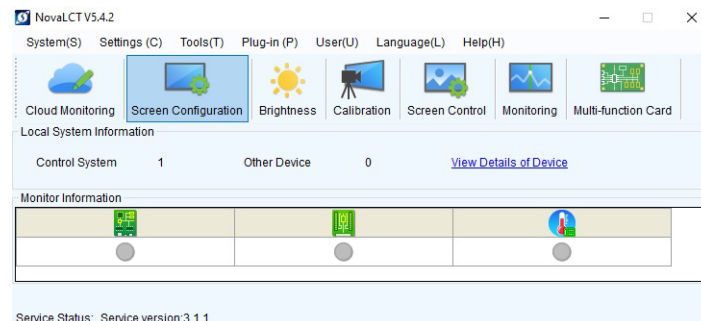

The NovaLCT software has many configuration settings for any panel assembly connected to the VIP Drive 10-5 Nova. The options are divided into 3 tabs that appear on a window after clicking **Screen Configuration**, selecting the product under **Current Operation Communication Port**, and clicking the **Next** button.

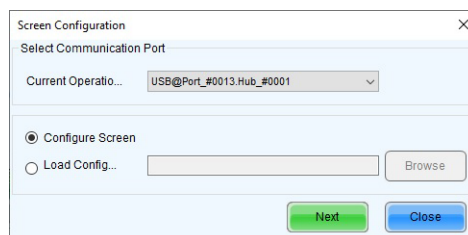

Sending Card Tab

On the Sending Card tab, the resolution and refresh rate can be set. From this tab the product's redundancy can be set, system configurations can be saved, and the product can also be restored to factory default settings.



Receiving Card Tab

On the Receiving Card tab, the parameters sent to the software the last time this tab was viewed will be displayed. This tab displays many options that can be edited, but Chauvet does NOT recommend altering any of them. From this tab the RCFGX file for connected video products can be uploaded and downloaded.

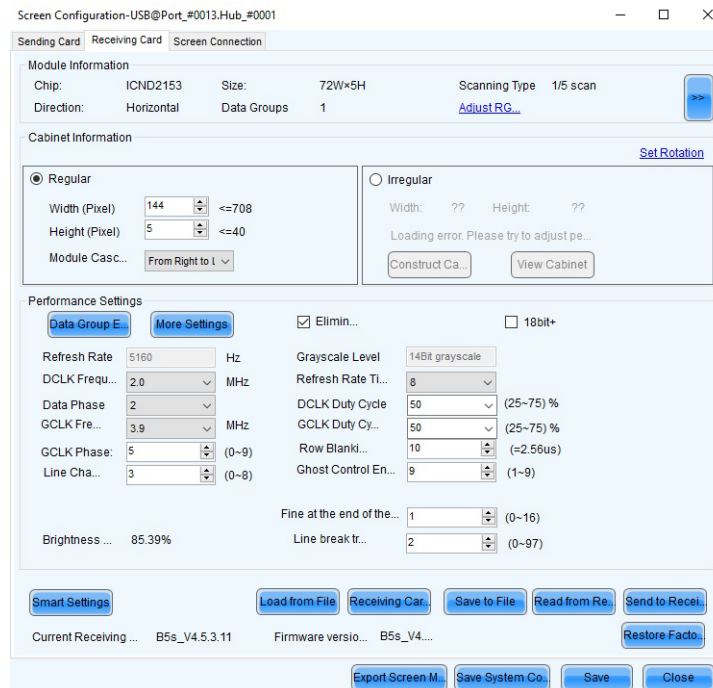

Operation

Screen Connection Tab

On the Screen Connection Tab, there are three options for configuring the size of the connected panel assembly, the distribution between video output ports, and the data flow: Simple, Standard, and Complex.

- Simple Screen mode functions the same way the [Screen Configuration](#) do in the menu.
- Standard Screen mode allows the data flow and port distribution to be programmed manually with a visual interface.
- Complex Screen mode allows the configuration to be entered in a flow chart by driver number, port, and panel number, as well as dimensions and offset coordinates in pixels.

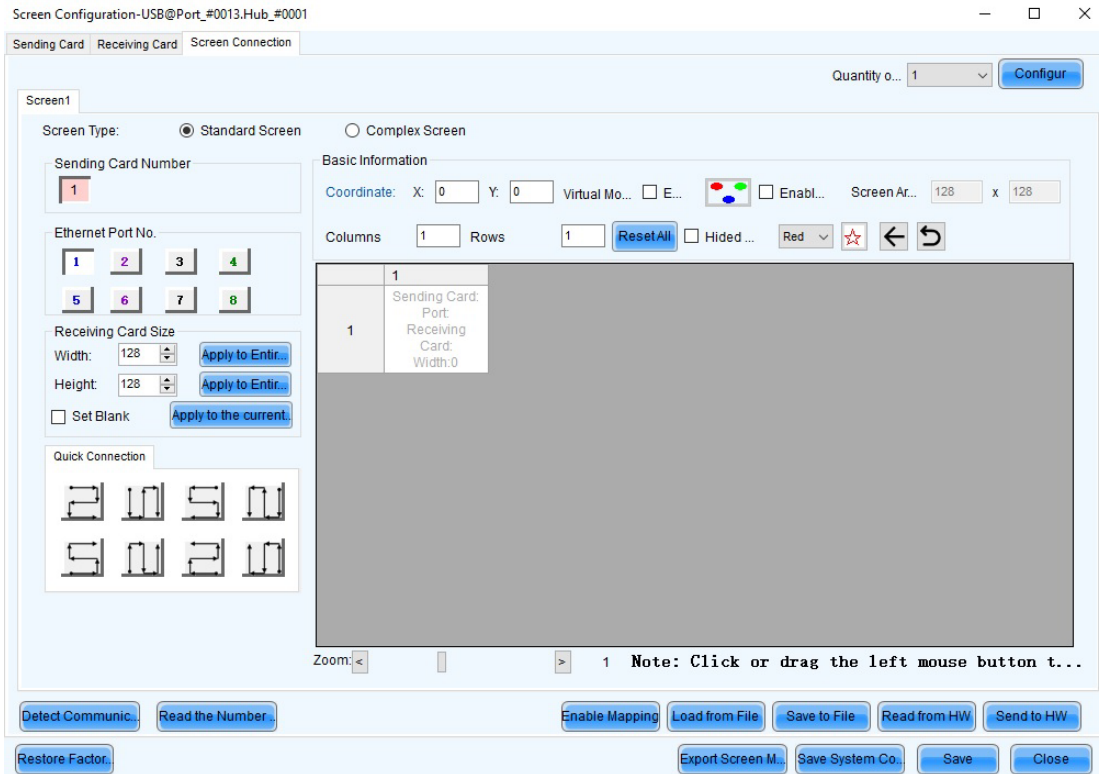

VIP Drive 10-5 Nova Firmware Update Through NovaLCT

To update the firmware for the VIP Drive 10-5 Nova, follow the instructions below:

1. Download the latest firmware update from www.chauvetvideo.com.
2. Plug the product into power, connect it to the computer, and open NovaLCT.
3. Click **User (U)** in the menu running across the top of the window to open the drop-down menu.
4. Click **Advanced Synchronous System UserLogin(A)**.
5. Type **admin** into the password field, and press the **Login** button on the screen, or press the **Enter** key.
6. Type **admin** again (There won't be a field for this, just type anywhere in the window). The Program Loading window will pop up.
7. If more than one VIP Drive 10-5 Nova is connected, select the one to be updated from the **Current Operation Communication Port** or **Communication port for the current operation** drop-down menu.
8. Click the button to the right of **Program Path**, and browse to find and select the firmware update folder.
9. Click **Update**.

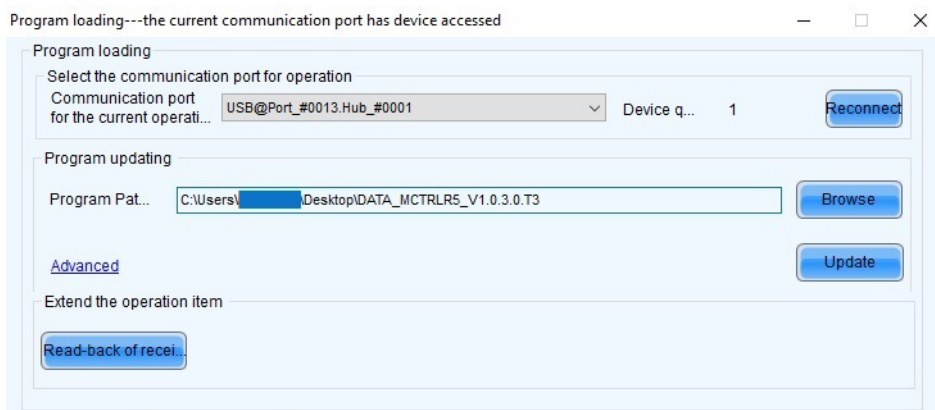

Video Product Firmware Update Through NovaLCT

To update the firmware for a video product connected to the VIP Drive 10-5 Nova, do the following:

1. Download the latest firmware update from the manufacturer website. For example, the latest firmware update for the F2 from Chauvet Professional can be downloaded from www.chauvetvideo.com.
2. Plug the video panel and VIP Drive 10-5 Nova into power, connect the products together and to the computer, and open NovaLCT.
3. Click **User (U)** in the menu running across the top of the window to open the drop-down menu.
4. Click **Advanced Synchronous System UserLogin(A)**.
5. Type **admin** into the password field, and press the **Login** button on the screen, or press the **Enter** key.
6. Type **admin** again (There won't be a field for this, just type anywhere in the window). The Program Loading window will pop up.
7. If more than one VIP Drive 10-5 Nova is connected, select the one connected to the panel to be updated from the **Current Operation Communication Port** drop-down menu.
8. Click the button to the right of **Program Path**, and browse to find and select the firmware update file.
9. Select the **Receiving Card FPGA** or **Receiving Card MCU** check-box.
10. Click **Update**.

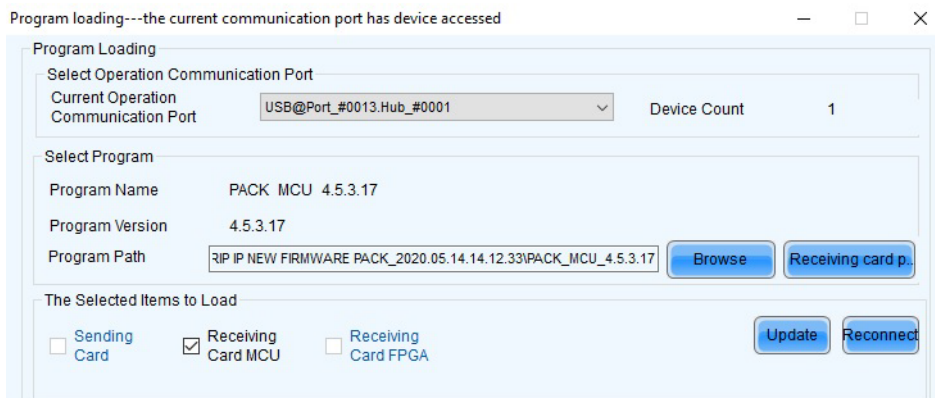

Operation

Standalone Video Product Update

With the NovaLCT software, a firmware update file can be saved to the VIP Drive 10-5 Nova, to be uploaded to connected products at any time. Under [Screen Configuration](#):

- **Load RCFGx Files** will temporarily upload the selected firmware to the connected products. This allows the process to be undone without damaging the products if something goes wrong, such as the wrong firmware being uploaded. This method is power-volatile. Cycling the power to the products will revert them to the previous firmware.
- **Save to RV Card** will permanently upload the selected firmware to the connected products, overwriting the previous firmware.

Uploading RCFGx Files to the VIP Drive 10-5 Nova

To save RCFGx files to the VIP Drive 10-5 Nova through the NovaLCT software:

1. Download the needed RCFGx files from www.chauvetvideo.com.
2. Plug the video panel and VIP Drive 10-5 Nova into power, connect the products together and to the computer, and open NovaLCT.
3. Click **User (U)** in the menu running across the top of the window to open the drop-down menu.
4. Click **Advanced Synchronous System UserLogin(A)**.
5. Type **admin** into the password field, and press the **Login** button on the screen, or press the **Enter** key.
6. Click **Tools (T)** in the menu running across the top of the window to open the drop-down menu.
7. Click **Controller Cabinet Configuration File Import (E)**.

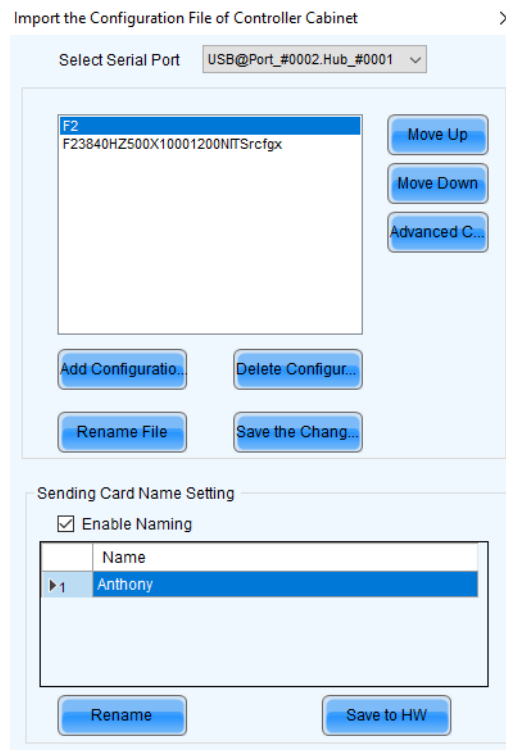

8. Click **Add Configuration**, and browse to find and select the RCFGx file.



The file names of the RCFGx files cannot contain symbols (including periods, underscores, or parentheses) or more than 60 characters.

5. Maintenance

Product Maintenance

Dust build-up reduces performance and can cause overheating. This can lead to reduction of the product's life and/or mechanical wear. To maintain optimum performance and minimize wear, clean your lighting products at least twice a month. However, be aware that usage and environmental conditions could be contributing factors to increase the cleaning frequency.

To clean the product, follow the instructions below:

1. Unplug the product from power.
2. Wait until the product is at room temperature.
3. Use a vacuum (or dry compressed air) and a soft brush to remove dust collected on the external surface/vents.
4. Clean the display with a mild soap solution, ammonia-free glass cleaner, or isopropyl alcohol.
5. Apply the solution directly to a soft, lint free cotton cloth or a lens cleaning tissue.
6. Softly drag any dirt or grime to the outside of the transparent surface.
7. Gently polish the transparent surfaces until they are free of haze and lint.



Always dry the display carefully after cleaning it.

Technical Specifications

6. Technical Specifications

Dimensions and Weight

Length	Width	Height	Weight
19 in (483 mm)	13.8 in (351.2 mm)	1.97 in (50.1 mm)	9 lb (4.08 kg)

Note: Dimensions in inches are rounded.

Power

Power Supply Type	Range	Voltage Selection
Switching (internal)	100 to 240 VAC, 50/60 Hz	Auto-ranging

Parameter	100 V, 60 Hz	120 V, 60 Hz	208 V, 60 Hz	230 V, 50 Hz	240 V, 50 Hz
Consumption	150 W	150 W	150 W	150 W	150 W
Current	1.5 A	1.25 A	0.72 A	0.65 A	0.62 A

Power I/O	U.S./Worldwide	UK/Europe
Power Input Connector	IEC	IEC
Power Cord plug	Edison (U.S.)	Local Plug

Connections

Input	Type/Compatibility	Output	Type/Compatibility
Single Link DVI-I (HDMI 1.4) (2)	VESA/EIA/CEA-861 standard, 3840 x 1080 @ 60 Hz - 3840x2160@30hz, HDCP 1.4 compliant	DVI-I (HDMI 1.4)	Loop
HDMI 1.4 (2)	VESA standard, 3840 x 1080 @60 Hz - 3840 x 2160 @30 Hz, HDCP 1.4 compliant	HDMI 1.4	Loop
HD-SDI (1)	480i, 576i, 720p, 1080i/p	HDMI 1.3	Preview
Fiber optical	SFP-LC (2)	Fiber optical	SFP-LC (2)
GenLock	Blackburst via locking BNC	GenLock	Blackburst via locking BNC
USB	Type B	USB	Type A
RJ45 (1)	Data connection	RJ45 (10)	Video output

Control

Control Protocol	Maximum Supported Input Resolution	Maximum Supported LEDs @ 60 Hz	Remote Control
NOVASTAR	3840 x 2160 (4K UHD)	6,553,600 (655,360 per port)	NovaLCT PC software via USB, RJ45

Supported Video Standards	Supported Color Space
SMPTE 425M (Level A and Level B), SMPTE 424M, SMPTE 292M, SMPTE 259M-C and DVB-ASI	RGB 4:4:4, YCrCb 4:4:4, YCrCb 4:2:2

Thermal

Startup Temperature Range	Operating Temperature Range	Cooling System
-4 °F to 113 °F (-20 °C to 45 °C)	-22 °F to 113 °F (-30 °C to 45 °C)	Fan-assisted convection

Ordering

Product Name	Item Name	Item Code	UPC Number
VIP Drive 10-5 Nova	VIPDRIVE105NOVA	26081878	781462222260



RoHS



Returns

Send the product prepaid, in the original box, and with the original packing and accessories. Chauvet will not issue call tags.

Call Chauvet and request a Return Merchandise Authorization (RMA) number before shipping the product. Be prepared to provide the model number, serial number, and a brief description of the cause(s) for the return.

To submit a service request online, go to www.chauvetprofessional.com/service-request.

Clearly label the package with an RMA number. Chauvet will refuse any product returned without an RMA number.



Write the RMA number on a properly affixed label. DO NOT write the RMA number directly on the box.

Before sending the product, clearly write the following information on a piece of paper and place it inside the box:

- Your name
- Your address
- Your phone number
- RMA number
- A brief description of the problem

Be sure to pack the product properly. Any shipping damage resulting from inadequate packaging will be your responsibility. FedEx packing or double-boxing are recommended.



Chauvet reserves the right to use its own discretion to repair or replace returned product(s).

Contact Us

General Information	Technical Support
Chauvet World Headquarters	
Address: 5200 NW 108th Ave. Sunrise, FL 33351 Voice: (954) 577-4455 Fax: (954) 929-5560 Toll Free: (800) 762-1084	Voice: (844) 393-7575 Fax: (954) 756-8015 Email: chauvetcs@chauvetlighting.com Website: www.chauvetprofessional.com
Chauvet Europe Ltd	
Address: Unit 1C Brookhill Road Industrial Estate Pinxton, Nottingham, UK NG16 6NT Voice: +44 (0) 1773 511115 Fax: +44 (0) 1773 511110	Email: UKtech@chauvetlighting.eu Website: www.chauvetprofessional.eu
Chauvet Europe BVBA	
Address: Stokstraat 18 9770 Kruishoutem Belgium Voice: +32 9 388 93 97	Email: BNLtech@chauvetlighting.eu Website: www.chauvetprofessional.eu
Chauvet France	
Address: 3, Rue Ampère 91380 Chilly-Mazarin France Voice: +33 1 78 85 33 59	Email: FRtech@chauvetlighting.fr Website: www.chauvetprofessional.eu
Chauvet Germany	
Address: Bruno-Bürgerl-Str. 11 28759 Bremen Germany Voice: +49 421 62 60 20	Email: DEtech@chauvetlighting.de Website: www.chauvetprofessional.eu
Chauvet Mexico	
Address: Av. de las Partidas 34 - 3B (Entrance by Calle 2) Zona Industrial Lerma Lerma, Edo. de México, CP 52000 Voice: +52 (728) 690-2010	Email: servicio@chauvet.com.mx Website: www.chauvetprofessional.mx

Visit the applicable website above to verify our contact information and instructions to request support. Outside the U.S., U.K., Ireland, Benelux, France, Germany, or Mexico, contact the dealer of record.