



Stem Ecosystem Platform

System Guide

Stem Ecosystem Platform system guide, for Stem Hub, Hub Express, Ceiling, Wall, Table, Speaker, and Control conferencing ecosystem
Version: 2.1 (2022-L)

Table of Contents

Stem Ecosystem Platform System Guide	4	Overview	21
Stem Ecosystem Platform	4	What's In The Box	22
Setting Up Your First Device	4	Installation	22
Security Settings	5	Setting Up	23
Ecosystem	5	Light Indicator	24
Rooms	5	Stem Table	24
Devices	11	Overview	24
Video Conferencing	14	What's In The Box	25
Dialer	14	Setting Up	25
Stats	15	Light Ring Indicators	26
Settings	15	Stem Speaker	26
Removing or Resetting Devices	16	Overview	26
Quick Start	16	What's On the Inside	27
Stem Ecosystem Setup	16	What's In The Box	28
Stem Hub & Hub Express	16	Table Mounting	28
Overview	17	Wall Mounting	28
What's In The Box	17	Ceiling Mounting	29
Mounting	17	Setting Up	30
Setting Up	18	Light Indicator	30
Stem Wall	18	Stem Control	30
Overview	18	Overview	30
What's In The Box	19	What's In The Box	31
Mounting	19	Setting Up	31
Setting Up	20	Product Specifications	31
Light Guide	21	HUB1 Specifications	31
Stem Ceiling	21	HUBX1 Specifications	32
		WALL1 Specifications	32
		CEILING1 Specifications	32
		TABLE1 Specifications	33
		SPEAKER1 Specifications	33
		CONTROL1 Specifications	33

IMPORTANT SAFETY INSTRUCTIONS	34	FOR ORIGINAL PURCHASES IN AUSTRALIA ONLY	37
SAFETY PRECAUTIONS	35	Service Centers	38
Important Product Information	35	Need Some Help?	38
LIMITED WARRANTY	36		

Stem Ecosystem Platform System Guide

Stem Ecosystem Platform

The Stem Ecosystem Devices are designed to be a complete solution by pairing hardware with the Stem Ecosystem Platform. Our Ecosystem Platform allows you to set up, control, and manage all of your rooms and devices through the network.

Access the Stem Ecosystem Platform to set up your devices.

Stem Ecosystem Devices

Hub / Hub Express	Wall	Ceiling	Table	Speaker	Control
					

Setting Up Your First Device

1. Install Your Devices:

Connect each of the Stem devices you purchased to your network and place them in their designated spot in the room.

2. Access Your Devices:

To access the Stem Ecosystem Platform, open the Stem Control app, or type in your device's IP address in your web browser. Access your connected devices through the [Ecosystem](#) tab.

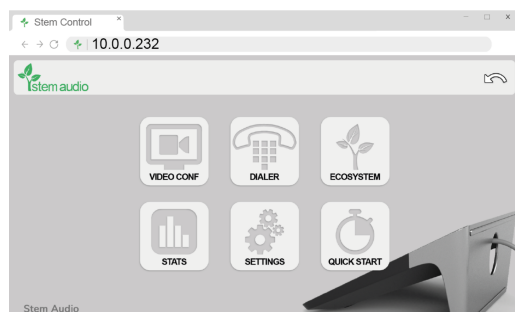

Note: The Stem Platform is integrated on every Stem device. The IP address of any Stem device gives you access to the Platform. When working with more than one Stem device, make sure all your Stem devices are connected to the same network.

More information and functionality are available at each of the home screen tabs:

- [Video Conf](#)
- [Dialer](#)
- [Ecosystem](#)
- [Stats](#)

- [Settings](#)
 - [Quick Start](#)
3. **Choose Your Security Setting:**

Organization allows you to password-protect all your connected Stem devices with a single password. Default settings do not require a password to access devices.

4. **Create A Room:**

Rooms allow multiple devices to work together. Click Ecosystem > Rooms > Add Room to create your first room.

Security Settings

The Organization setting allows you to password protect your Stem devices with a single password. The Default setting removes the requirement to enter a password to access a device.

Organization Security Setting

The organization password is required to access or make changes to your Ecosystem devices. Organization information is stored within each device. Only one password is allowed per organization, only one organization is allowed per network, but there is no limit on rooms or Stem devices allowed in an organization.

Note: If you forget your organization password, [contact Stem customer service](#).

Default Security Setting

No password is required to make changes or add Stem devices to your Stem ecosystem. This means anyone with access to your network can control your Stem devices. Stem devices without password protection are open to reconfiguration and setting changes.

Ecosystem

Three features are accessible from the Ecosystem tab of the Stem platform: [Rooms](#), [Devices](#) and [Design Wiz](#). Rooms and Devices allow you to control and manage your rooms and devices. Design Wiz allows you to design new rooms for your Stem devices.



Rooms

In the Rooms tab, you can create a new room or access and manage existing rooms.

Click Ecosystem > Rooms > Add Room to create a new room, or select an existing room to make changes to the name, devices, notifications, and to access the function menu.

Note: When an issue is present with one or more of the devices in your room, the  icon appears and the room moves to the top of the list.



Edit

Edit the name of your room.



Add Device

Add a device to your room.



Remove Device

Remove the selected device from your room.



Join Room

Combine multiple rooms, up to 10 audio devices, into a single room with 1 Hub or Hub Express. This clears the RoomDesign parameters, allowing you to create a new design for the combined room. (Information for the individual rooms is saved, and can be restored by splitting the combined room back into separate rooms.)

Note: The first room selected becomes the primary, and all settings on other Hub or Hub Express devices are bypassed and saved for later. If, for example, you are combining rooms and one room is SIP enabled, select that room first to retain that setting.



Split Room

Separate a single room into multiple rooms.



Re-Assign

Change a selected device's room assignment.



Unassign

Remove a selected device's room assignment.

Design Wiz

Design Wiz allows you virtually recreate any room, add exact dimensions, furniture, and mix and match Stem devices. You also have the ability to save designs for later and you can import them when it's time to set up your room.

To design a new room, click [Design Wiz > Add Room](#). Clicking the back arrow to exit Design Wiz will give you the option to save your room design.



Walls

Add the room dimensions.



Furniture

Add furniture to your design.



Devices

Add Stem devices to your room.



Estimated Pickup

Display the estimated coverage of the devices in your room design.



Clear Design

Clear all devices, furniture, and dimensions, and return to an empty design template.



RoomCheck

When your devices are set up in your room and added to the Stem Ecosystem Platform, you can run RoomCheck to test the clarity of your voice in the room.

Metric/Imperial

Toggle between metric and imperial measurement for the room dimensions.

Only available in HTML.

Export Design

Generate a PDF of your room design.

Only available in HTML.

Room Functions Menu

The room functions menu allows you to run a variety of tests to ensure the devices in your room are set up correctly and optimized for best performance.



Test Room

Check device speakers and microphone sensitivity levels by triggering a chirping noise from all devices.



Ping Room

Quickly locate and identify a room by triggering a pinging noise from all devices (for Stem Ceiling, the LED light rings will flash red).



RoomAdapt

Optimize performance by adjusting microphone and speaker levels for the environment.



Advanced

Access the advanced room settings menu.

Advanced (Room) Settings

Adjust advanced settings for all devices assigned to a room. To confirm changes in this menu, click the Apply Settings button.

Note: Advanced room settings override the advanced settings for the organization.

Room A Advanced Settings

Apply these settings to all devices in this room

APPLY SETTINGS

Mute Controls

TABLE A

MUTE MICS

MUTE SPKRS

Scheduled Restart

NEVER

^ ^ ^ ^

WEEKLY

Monday 12 : 00 AM

DAILY

^ ^ ^ ^

Scheduled Testing

NEVER

^ ^ ^ ^

WEEKLY

Monday 12 : 00 AM

DAILY

^ ^ ^ ^

Light Display

LIGHTS ON

Device Firmware Updates

ENABLE AUTOMATIC UPDATES

CHECK FOR UPDATES

Fencing Mode

ENABLE FENCING

Local Server

USE LOCAL SERVER

URL

http://update.stemaudio.com/testing/

USERNAME

PASSWORD

Timezone Offset (from UTC)

-

-8

+

SIP Configuration

SIP SETTINGS

Restart this Room

RESTART ROOM

Stem Control (HTML) - v2.0.0.0.B4

- **Mute Controls:** Select which microphones and speakers are active for your devices.
- **Scheduled Restart:** Choose whether or not to restart all devices on a weekly or daily schedule.
- **Scheduled Testing:** Choose whether or not to test your room on a weekly or daily schedule.
- **Light Display:** Turn the directional lights or LED light ring on or off for all devices in the room.

Note: This does not affect mute lights or other critical lights.

- **Device Firmware Updates:** Enable automatic firmware updates, or check for available firmware updates.
- **Audio Fencing:** Audio fencing picks up sound that is within the microphone array, and blocking out other sound.
- **Local Server:** Define a local FTP server for updates in an organization blocking devices from accessing outside communication.
- **Time Zone Offset:** Set your local time zone automatically, or choose it manually.
- **SIP Configuration:** Configure SIP calling on the individual device in standalone use, or on the Hub or Hub Express when using multiple devices in a room.

Note: Create a room even when you are using a standalone device in order to access all functions and advanced settings.

Room Layout

Import a saved RoomDesign into a new room by clicking , or edit the room's existing design.

To create or edit a RoomDesign in an existing room, click .

Note: Devices assigned to the room are listed on the right panel. The  icon means the devices is assigned to the room, but has not been added to the RoomDesign yet.

To see the estimated microphone pickup of the devices in your RoomDesign, click .

RoomCheck

RoomCheck is a five-second recording that tests the sound clarity of your voice from anywhere in the room. To initiate RoomCheck, stand anywhere in the room, click  and speak for 5 seconds.

Once RoomCheck is complete, a heatmap of the room showing audio pickup quality will appear. Make sure to install your devices in the exact same spot in the room as in the RoomDesign for accurate results.

Note: You must initiate RoomAdapt before initiating RoomCheck.

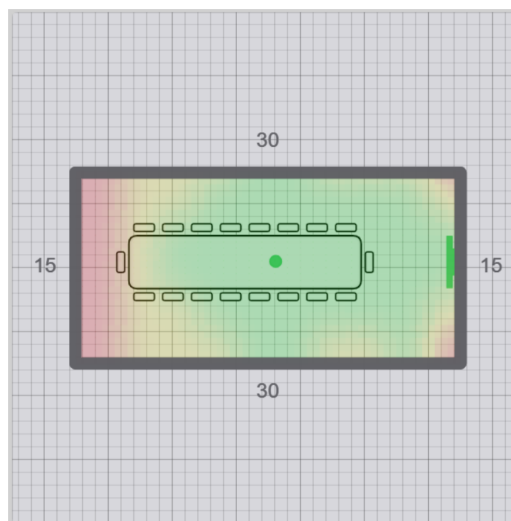

Green

Optimal coverage

Yellow

Adequate coverage

Red

Inadequate coverage

Devices

The Devices tab displays all devices on your network, or in your organization, and their status:

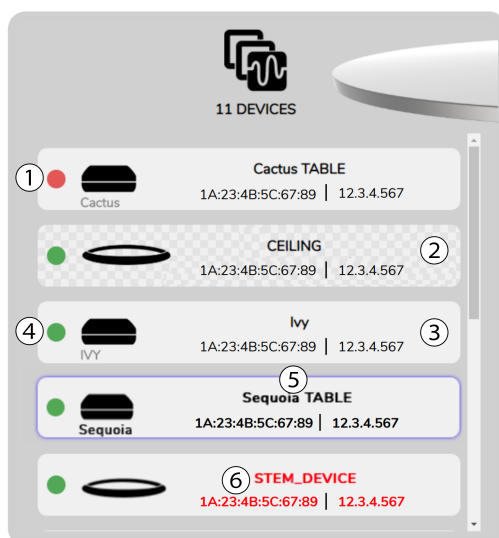

① Red circle

The device or room has an error

② Checkered background

The device is in the organization, but not assigned to a room

③ Solid background

The device is in the organization, and is assigned to a room

④ Green circle

The device or room is ready for use

⑤ Blue outline

The device or room is in use.

Note: You cannot use ping, test, or RoomAdapt when a device is in use.

⑥ Red text

The device is outside the organization.

Device Functions Menu

Selecting an individual device lets you see the device's name, serial number, MAC address, IP address, and firmware version. You can also rename the device, reassign the device to a different room, unassign the device, or access the device functions menu.

The device functions menu allows you to run a variety of tests to ensure your device is set up correctly and optimized for best performance.



Ping Device

Quickly locate and identify the selected device by triggering a pinging noise from the device's speaker. (For Stem Ceiling, the LED light ring will flash red.)



Test Device

Check device speaker and microphone sensitivity levels by triggering a chirping noise from the device's speaker.



Diagnose

Help eliminate extensive troubleshooting by diagnosing an issue. If an issue occurs, the  icon appears and the device moves to the top of the list.

Note: If your device is working properly, the button will be grayed out and the label will read Online.



Advanced

Access the advanced device settings menu.

Note: You cannot ping, diagnose, test, or alter advanced settings while a device is in use.

Advanced (Device) Settings

Adjust advanced settings for the selected device. To confirm changes in this menu, click the Apply Settings button.



Note: Advanced device settings override advanced settings for the room and the organization.

TABLE A Advanced Settings

Apply these settings to this device

APPLY SETTINGS

Mute Controls

TABLE A  MUTE MICS  MUTE SPKRS

Scheduled Restart

NEVER ^ ^ ^ ^

WEEKLY Monday 12 : 00 AM

DAILY v v v v

Scheduled Testing

NEVER ^ ^ ^ ^

WEEKLY Monday 12 : 00 AM

DAILY v v v v

Light Display

LIGHTS ON

Device Firmware Updates

ENABLE AUTOMATIC UPDATES

CHECK FOR UPDATES

Configure IP (requires device reboot)

USE STATIC IP

IP ADDRESS

SUBNET MASK

GATEWAY HOST

Local Server

USE LOCAL SERVER

URL

USERNAME

PASSWORD

Timezone Offset (from UTC)

- 0 +

SIP Configuration

SIP SETTINGS

Restart this Device

RESTART DEVICE

- **Mute Controls:** Select whether the microphone and speaker are active for your device.
- **Scheduled Restart:** Choose whether or not to restart your device on a weekly or daily schedule.
- **Scheduled Testing:** Choose whether or not to test your device on a weekly or daily schedule.
- **Light Display:** Turn the directional lights or LED light ring on or off for all devices in the room.

Note: This does not affect mute lights or other critical lights.

- **Device Firmware Updates:** Enable automatic firmware updates, or check for available firmware updates.
- **IP Configuration:** Define a static IP address for the selected device.
- **Local Server:** Define a local FTP server for updates in an organization blocking devices from accessing outside communication.
- **Time Zone Offset:** Set your local time zone automatically, or choose it manually.
- **SIP Configuration:** Configure SIP calling on the individual device in standalone use, or on the Hub or Hub Express when using multiple devices in a room.
- **Restart this Device:** Reboots the selected device.

Ceiling Device Settings

With Stem Ceiling, you have the option to adjust the device's beam settings, or enable audio fencing.

Ceiling Beam Settings

Access the room where the Ceiling you want to adjust is located. Select the specific Ceiling device you want to adjust, click Beam, and choose narrow, medium, or wide beam settings.



Tip: If you have multiple Ceiling devices in a room, you can ping the specific Ceiling device you are trying to find.

Audio Fencing

Audio fencing allows you to restrict the microphone pickup by picking up sound that is within the microphone array, and blocking out sound that is outside of the array. Access the room's advanced settings, and select the Enable Fencing checkbox.



Video Conferencing

The Video Conferencing tab prompts you to open your preferred video conferencing software. When using a standalone Stem device, connect the device directly to your computer via USB. When using multiple devices in a room, connect your Hub or Hub Express directly to your computer, and ensure your devices are connected through the Stem Ecosystem Platform.

Dialer

The Dialer tab will allow you to dial and make SIP calls directly from the ecosystem platform.

SIP Configuration Setup

Gather SIP credentials

Collect the following from your hosted VoIP provider: SIP username, SIP password, gateway host, outbound proxy

Log into the Stem Ecosystem Platform using the browser

Enter the IP address of any of your connected Stem devices into your web browser.

Enter and apply SIP credentials

Click Ecosystem > Rooms > Advanced Settings > SIP Configuration to access configuration settings. Enter your SIP credentials and click Apply Settings.

Test your configuration

Go back to dialer and test an inbound and outbound call. If your service provider has an admin portal, you should also see confirmation that the Stem device is registered, active, or online.

Stats

The Stats tab displays statistics for the devices or rooms in your organization, including:

- **Usage:** Room usage by the number of sessions and how many minutes the room has been in use.
- **Uptime:** The amount of time each device has been up and active.
- **Event Logs:** Testing, connections, disconnections, etc.
- **Call Logs:** Information on SIP calls in your organization, by room or by device.

Settings

The Settings tab lets you adjust settings for all rooms and devices in your organization. To confirm changes in this menu, click the Apply Settings button.

Note: Organization settings override individual room and device settings.

- **Scheduled Restart:** Choose whether or not to restart your device on a weekly or daily schedule.
- **Scheduled Testing:** Choose whether or not to test your device on a weekly or daily schedule.
- **Light Display:** Turn the directional lights or LED light ring on or off for all devices in the room.

Note: This does not affect mute lights or other critical lights.

- **Device Firmware Updates:** Enable automatic firmware updates, or check for available firmware updates.
- **Local Server:** Define a local FTP server for updates in an organization blocking devices from accessing outside communication.
- **Time Zone Offset:** Set your local time zone automatically, or choose it manually.
- **Organization:** Manage the settings for your Organization, if one is created.

Note: If you forget your organization password, [contact Stem customer service](#).

Removing or Resetting Devices

To remove a Stem device from your organization, or to reset a device to factory settings, access the Stem Ecosystem Platform by entering that device's IP address in your web browser.

To remove a device from your organization, enter the device's IP address into your web browser and click **Settings > Organization > Manage > Leave Organization**. You need to enter your organization password.

Note: If you forget your organization password, [contact Stem customer service](#).

To reset a device to factory settings, enter the device's IP address into your web browser and click **Settings > Factory - Reset**.

Quick Start

The Quick Start tab takes you through the entire installation process step by step. It will walk you through getting Stem devices on your network, assigning them to a room, and getting your ecosystem up and running.

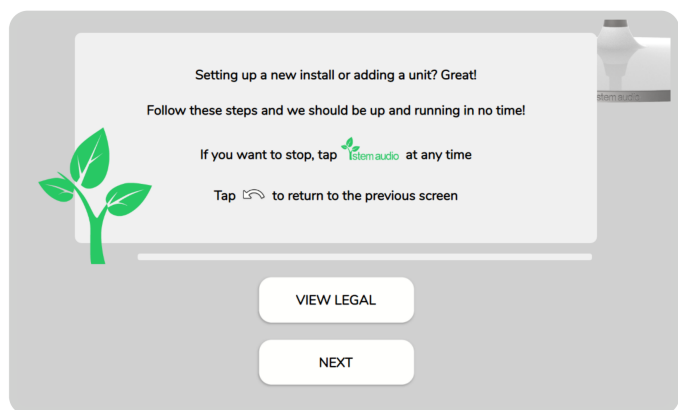

Stem Ecosystem Setup

Your [Wall](#), [Ceiling](#), [Table](#) or [Speaker](#) can be set up on their own for standalone use, or multiple devices can be used in a room together.

With a multi-device setup, [Hub](#) or [Hub Express](#) is required. Hub and Hub Express enable all endpoints to communicate with each other and provide a single point of connection to external loudspeakers, Dante[®] networks (Stem Hub only), and other conferencing interfaces for all devices.

[Stem Control](#) provides complete access to the Stem Ecosystem Platform, as well as integrating with your preferred video conferencing platform for touch-to-join meetings.

1. Place or mount the device in the desired location.
2. Connect the device to a network port that supports PoE+ using an Ethernet cable.
3. Install all other Stem devices, including Hub or Hub Express, to the same network.
4. Access the Stem Ecosystem Platform to configure your devices.

Stem Hub & Hub Express

Overview

Stem Hub and Stem Hub Express act as the brain of a room, connecting your network of Stem Ecosystem devices to external loudspeakers and other conferencing interfaces over USB Type B, Dante*, or SIP.

*Stem Hub only

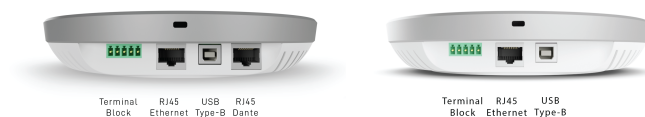

Features

What's In The Box

- USB Type A to USB Type B cable: 12 ft. (3.7 m)
- CAT 6 Ethernet cable: 15 ft. (4.6 m)
- Terminal block connector (male)
- Philips head screws and drywall anchors (2)

Mounting

1. Using a level, mark two points on your mounting surface at exactly 2.75 inches apart (7 cm).
2. Install the provided Philips head screws at the marked positions. Use the provided drywall anchors as necessary.
3. Align the keyholes on the back of the device with the screws. Lightly push in and down to lock into place.



Setting Up

Stem Hub and Stem Hub Express enable all endpoints to communicate with each other and provide one place to make connections to external loudspeakers and other conferencing interfaces for all Stem Ecosystem devices.

1. Connect Hub or Hub Express to a network that supports PoE+ using an Ethernet cable. This connection provides the device with power, data, and other IoT and SIP capabilities.

Note: *If your network doesn't support PoE+, use a separate PoE+ injector or PoE+ enabled switch.*

2. Plug your audio and conferencing devices into Hub or Hub Express using the following connectors. These connections will be utilized for all Stem Ecosystem devices on the network.

USB (Type B): Enables video and audio conferencing capabilities when connected to your PC.

External Speakers: A female terminal block connector (unamplified) for external speakers or amplifiers. Use with the provided male terminal block connector.

Dante*: Creates a single Dante output and input channel for all Stem devices.

** Stem Hub only*

3. Complete your setup using the Stem Ecosystem Platform.

Important: To ensure that external loudspeakers perform properly, use Stem RoomAdapt.

Note: For more information on setting up your room, visit shu.re/stemproductinfo

Stem Wall

Overview

Whether sitting on a flat surface or mounted on a wall, the Stem Wall Array Speakerphone optimizes voice pickup to make any environment sound like a professional conference room. Equipped with 15 microphones that create 180 degrees of coverage aimed at the voice source, plus full-range speakers and subwoofers, the Stem Wall speakerphone ensures everybody has a voice.

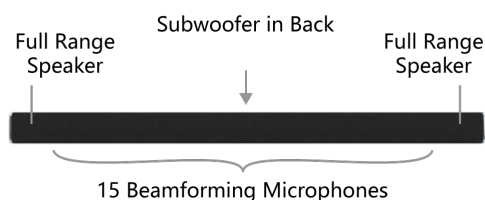

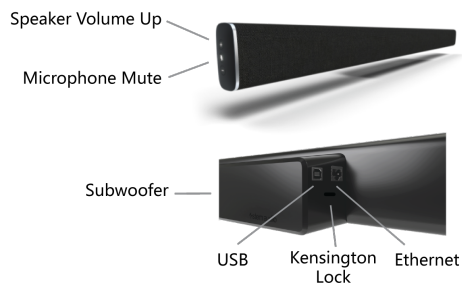

Directional Array

During a call, proprietary beamforming technology steers the microphone array toward voices in the room, canceling out sources of noise. This provides superior intelligibility for the persons listening at the far-end of the call. Beamforming dynamically adjusts to changes, with blue indicator lights showing the direction of each audio beam as it detects and follows the voices in the room.

Volume Control

Change the speaker volume using the + and - buttons on the top of the device.

Mute Button



During a call, use the mute button on the top of the device to toggle the microphone on or off. When muted, the light ring on the device will slowly pulse red.

What's In The Box

- USB Type A to USB Type B cable: 12 ft. (3.7 m)
- CAT 6 Ethernet cable: 15 ft. (4.6 m)
- Mounting bracket
- Magnetic level
- Philips head screws with anchors (3)
- Camera mount accessory kit with screws (2)

Mounting

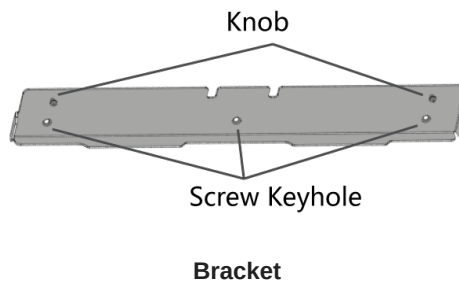

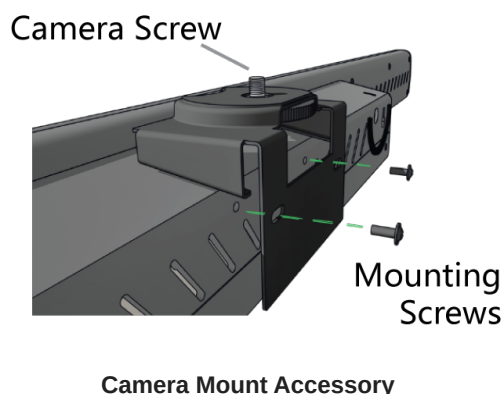
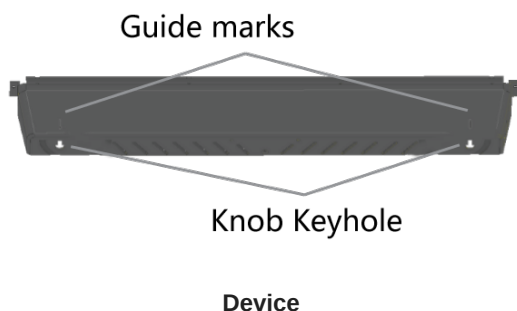

1. Identify the location of studs behind the mounting surface.
2. Using the provided magnetic level, place the bracket onto the surface and mark the keyhole locations.
3. Starting with the middle keyhole, use the provided screws (and anchors, if necessary) to affix the bracket to the surface.
4. If desired, attach the camera mount accessory to the back of the Wall device using the provided screws.
5. Mount the Wall device to the bracket, aligning the guide marks with the knobs and lightly pushing down to lock in place.

Setting Up

This device can be installed as a standalone unit or networked with other Stem Ecosystem devices using Stem Hub or Stem Hub Express.

With either setup option, this device must be connected to a network port that supports PoE+. *This connection provides the device with power, data, and other IoT and SIP capabilities.*

Note: If your network doesn't support PoE+, you should purchase a separate PoE+ injector or PoE+ enabled switch.

For more information on setting up your room, visit shu.re/stemproductinfo or shu.re/stemininstallation.

Stem Ecosystem Setup

With a multi-device setup, Stem Hub or Stem Hub Express is required. Hub and Hub Express enable all endpoints to communicate with each other and provide a single point of connection to external loudspeakers, Dante networks (Stem Hub only), and other conferencing interfaces for all devices.

1. Place or mount the device in the desired location.
2. Connect the device to a network port that supports PoE+ using an Ethernet cable.
3. Install all other Stem devices, including Hub or Hub Express, to the same network.
4. Access the Stem Ecosystem Platform to configure your devices.

Standalone Setup

1. Place or mount the device in the desired location.
2. Connect the device to a network port that supports PoE+ using an Ethernet cable.
3. For video conferencing, connect the device to your PC using a USB Type B cable.

Light Guide

Light Activity	Device Function
Slow red pulsing	Muted
Rapid red pulsing (~2 seconds)	Receiving ping
Solid red	Error
Single blue oscillating dot	Booting up
Solid blue receding from right to left	Restarting
Solid blue shifting	Testing and adapting to the environment
One or more steady blue dots	Shows direction of voice-activated beamforms

Stem Ceiling

Overview

Stem Ceiling Microphone Array mounts above a conferencing space either as a low profile element of a drop ceiling or suspended like a chandelier. It features 100 built-in microphones, three beam options (wide, medium, and narrow), and audio fencing. With the aesthetics needed to blend with any environment and uncompromising audio performance, Stem Ceiling eliminates the distractions so you can keep focused on the conversation.

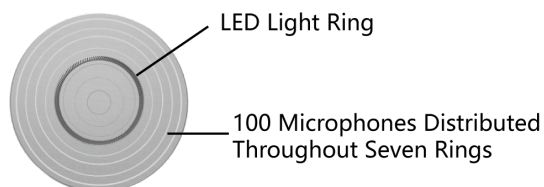
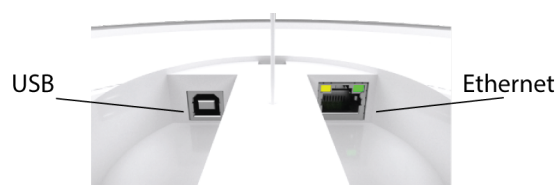

What's In The Box

- USB type A to USB type B cable: 12 ft. (3.7 m)
- CAT 6 Ethernet cable: 15 ft. (4.6 m)
- Square mount
- 24 in. square mount adapters (4)
- 625 mm. square mount adapters (4)
- Oval-shaped screw caps
- Chandelier suspension kit
- Gripple® cable kit

Installation

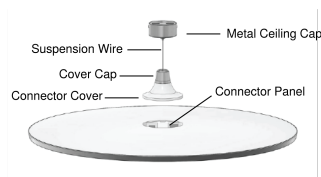

Chandelier Mounting Kit

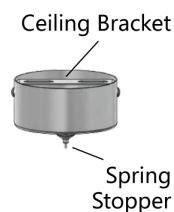

Metal Ceiling Cap (Detail)

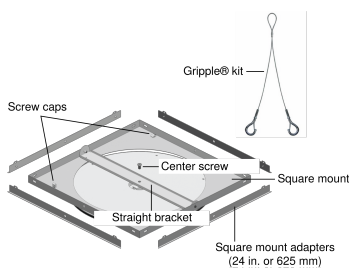

Low Profile Mounting Kit

Choosing Installation Method

The Stem Ceiling is an extremely versatile microphone array. Connected with the Stem Ecosystem Platform, you can install it either as a low-profile element of a drop ceiling, or suspended like a chandelier, and easily get good coverage for all talkers.

Best Practices for Installation

- Before installing, open your room in Design Wiz and click Estimated Pickup to find the best location on your ceiling.

- The recommended mounting height is 9 ft. (~2.8 m.) from the floor. Measure the height of your ceiling to determine whether low-profile or suspended mounting is best.
- Coverage also depends on your room's acoustics, construction, and materials. Take these into consideration when planning coverage.
- Don't place the microphone behind obstructions.
- Plan for any future coverage needs.

Suspended "Chandelier" Mounting

1. Make all the appropriate cable connections on the device.
2. Secure the chandelier suspension kit wire to the device using the screw at the bottom of the wire.
3. Slide the connector cover and the cover cap over the suspension wire.
4. Align the plastic connector cover with the indents and gently click into place, then apply the cover cap.
5. Remove the ceiling bracket from the metal ceiling cap and connect it to a weight-bearing structure.
6. Feed all the cables through the hole on the metal ceiling cap and connect the suspension wire by pressing up on the spring stopper while feeding it through.
7. Set the desired suspended elevation then screw the metal ceiling cap into the ceiling bracket.

Low Profile Mounting

1. Make all the appropriate cable connections on the device.
2. If needed, identify the appropriate square mount adapters for your acoustic ceiling grid size. Install the adapters on all four sides of the square mount and secure with the provided oval-shaped screw caps.
3. Using the provided large center screw, secure the device to the straight bracket situated across the square mount.
4. Carefully position the square mount in your acoustic ceiling grid.
5. **Important:** Use the provided Gripple cable kit to secure the square mount. Attach the two large hooks to the wire holes on the corners of the square mount or square mount adapters, and affix the upper end of the cable to the building structure above your acoustic ceiling grid.

Setting Up

This device can be installed as a standalone unit or networked with other Stem Ecosystem devices using Stem Hub or Stem Hub Express.

With either setup option, this device must be connected to a network port that supports PoE+. *This connection provides the device with power, data, and other IoT and SIP capabilities.*

Note: If your network doesn't support PoE+, you should purchase a separate PoE+ injector or PoE+ enabled switch.

For more information on setting up your room, visit shu.re/stemproductinfo or shu.re/steminstitution.

Standalone Setup

1. Place or mount the device in the desired location.
2. Connect the device to a network port that supports PoE+ using an Ethernet cable.
3. For video conferencing, connect the device to your PC using a USB Type B cable.

Stem Ecosystem Setup

With a multi-device setup, Stem Hub or Stem Hub Express is required. Hub and Hub Express enable all endpoints to communicate with each other and provide a single point of connection to external loudspeakers, Dante networks (Stem Hub only), and other conferencing interfaces for all devices.

1. Place or mount the device in the desired location.
2. Connect the device to a network port that supports PoE+ using an Ethernet cable.
3. Install all other Stem devices, including Hub or Hub Express, to the same network.

4. Access the Stem Ecosystem Platform to configure your devices.

Light Indicator

Light Activity	Device Function
Slow red pulsing	Muted
Rapid red pulsing (~2 seconds)	Receiving ping
Solid red ring	Error
Slow blue pulsing	Booting up
Slow blue pulsing then off	Restarting
Blue flashing	Testing and adapting to the environment
Dim solid blue	Power on
Rapid blue pulse	Boot up completed

Stem Table

Overview

Optimized for tabletops and flat surfaces, Stem Table Array Speakerphone turns any environment into a professional conference room. With nine microphones to pick up voices from 360 degrees and an innovative downward-facing loudspeaker, Stem Table takes the quality of your meetings to the next level.

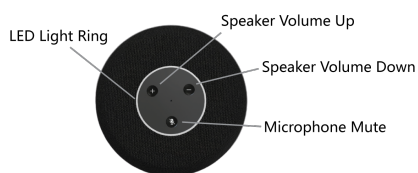
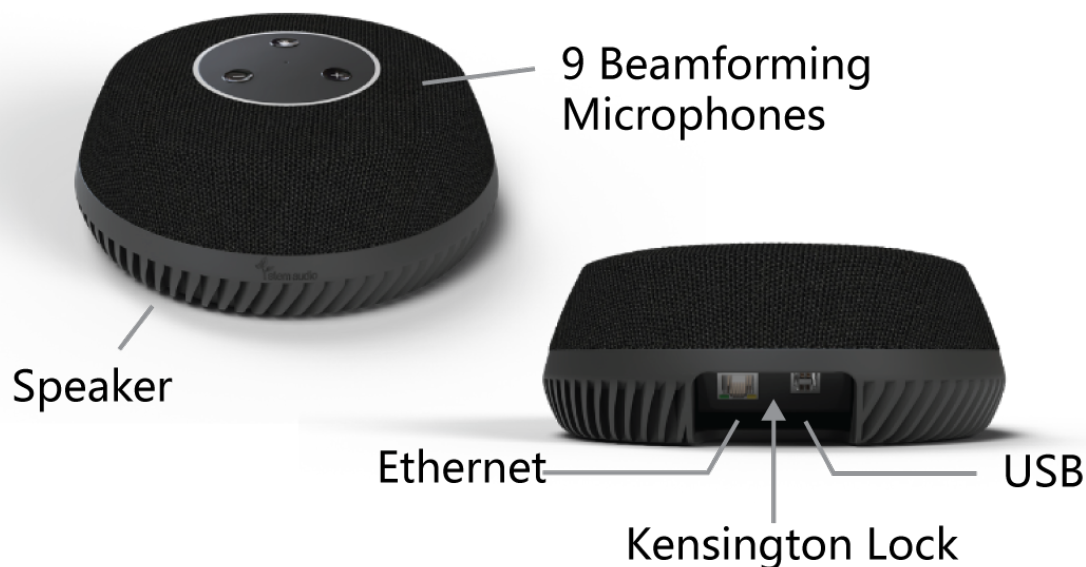

Table Overview



Directional Array

During a call, proprietary beamforming technology steers the microphone array toward voices in the room, canceling out sources of noise. This provides superior intelligibility for the persons listening at the far-end of the call. Beamforming dynamically adjusts to changes, with blue indicator lights showing the direction of each audio beam as it detects and follows the voices in the room.

Volume Control

Change the speaker volume using the + and - buttons on the top of the device.

Mute Button



During a call, use the mute button on the top of the device to toggle the microphone on or off. When muted, the light ring on the device will slowly pulse red.

What's In The Box

- USB Type A to USB Type B cable: 12 ft. (3.7 m)
- CAT 6 Ethernet cable: 15 ft. (4.6 m)

Setting Up

This device can be installed as a standalone unit or networked with other Stem Ecosystem devices using Stem Hub or Stem Hub Express.

With either setup option, this device must be connected to a network port that supports PoE+. *This connection provides the device with power, data, and other IoT and SIP capabilities.*

Note: If your network doesn't support PoE+, you should purchase a separate PoE+ injector or PoE+ enabled switch.

For more information on setting up your room, visit shu.re/stemproductinfo or shu.re/steminstallation.

Standalone Setup

1. Place or mount the device in the desired location.
2. Connect the device to a network port that supports PoE+ using an Ethernet cable.
3. For video conferencing, connect the device to your PC using a USB Type B cable.

Stem Ecosystem Setup

With a multi-device setup, Stem Hub or Stem Hub Express is required. Hub and Hub Express enable all endpoints to communicate with each other and provide a single point of connection to external loudspeakers, Dante networks (Stem Hub only), and other conferencing interfaces for all devices.

1. Place or mount the device in the desired location.
2. Connect the device to a network port that supports PoE+ using an Ethernet cable.
3. Install all other Stem devices, including Hub or Hub Express, to the same network.
4. Access the Stem Ecosystem Platform to configure your devices.

Light Ring Indicators

Light Activity	Device Function
Slow red pulsing	Muted
Rapid red pulsing (~2 seconds)	Receiving ping
Solid red	Error
Single blue dot circling	Booting up
Solid blue receding counterclockwise	Restarting
Solid blue rotating	Testing and adapting to the environment
One or more steady blue dots	Shows directions of voice-activated beamforms

Stem Speaker

Overview

Stem Speaker's powerful driver and flexible wall, ceiling, or table mounting options deliver exceptional sound in any meeting room. Mix and match with other Stem Ecosystem devices until your room is customized to meet your needs.

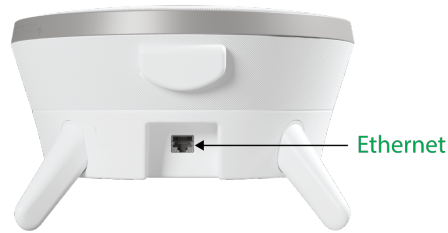
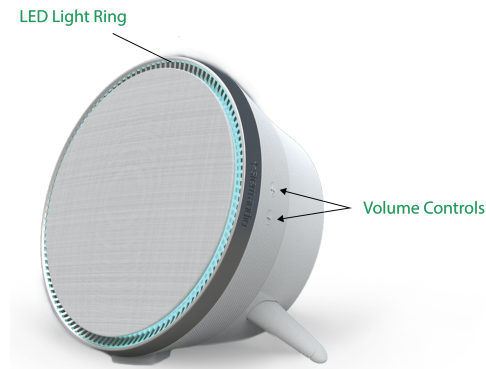

What's On the Inside

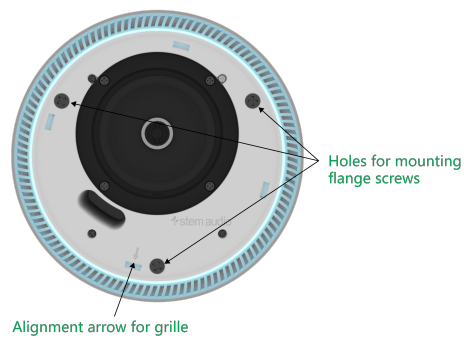
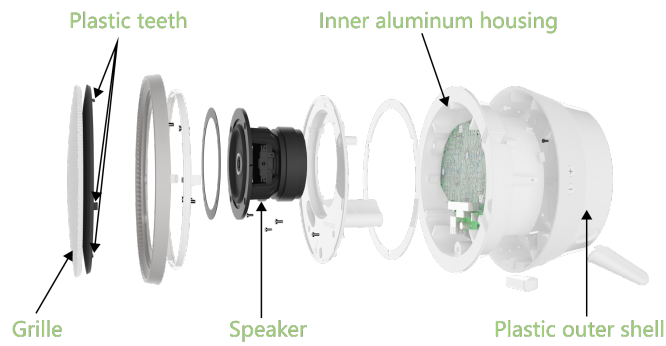

Front view after grille is removed

What's In The Box

- CAT 6 Ethernet cable: 15 ft. (4.6 m)
- Aluminum ceiling mount ring
- Tripod mounting legs
- M4 eyelet screw
- Flange screws and mounting flanges
- Philips-head screws and drywall anchors

Table Mounting

1. Using a tool with a flat edge, remove the two leg cover caps.
2. Snap the tripod mounting legs into position at the appropriate angles.
3. Place your Speaker in the desired location in the room.

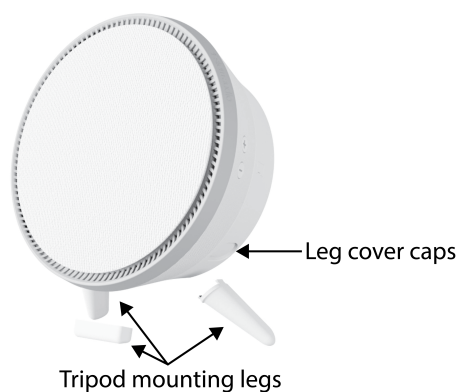

Wall Mounting

1. Unscrew the three fastening screws that connect the inner aluminum housing from the plastic outer shell.
2. Remove the outer shell and gently disconnect the connector for the volume controls.
3. Hold the outer shell to your mounting surface and mark the surface through the screw keyholes.
4. Pre-drill four holes on your marked points. If the markings don't align with studs, use the provided drywall anchors.
5. Use the provided Philips head screws to secure the outer shell to your mounting surface through the pre-drilled holes.
6. Once the shell is secured to your mounting surface, align and reconnect the volume control cable.
7. Make sure to align the openings for the Ethernet connector.
8. Use the fastening screws to secure the inner aluminum housing to the plastic outer shell.

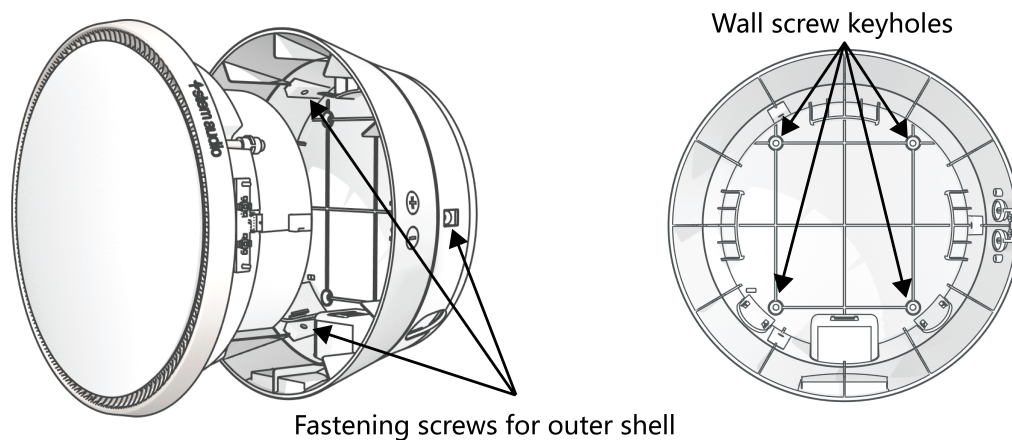

Ceiling Mounting

1. Make all the appropriate cable connections on the device.
2. Use the inner circle of the aluminum ceiling mount ring as a template to cut the correct-sized hole. For drop ceiling installation, always use a tile bridge.
3. Remove the three fastening screws that connect the plastic outer shell to the inner aluminum housing.
4. Remove the outer shell and gently disconnect the cable for the volume controls. Gently pull off the front grille.
5. Feed the three flange screws through the holes on the front of the device, and attach the three white mounting flanges to the backsides of the screws. To install an anchor cable, attach the included M4 eyelet screw to one of the three threaded holes around the device perimeter.

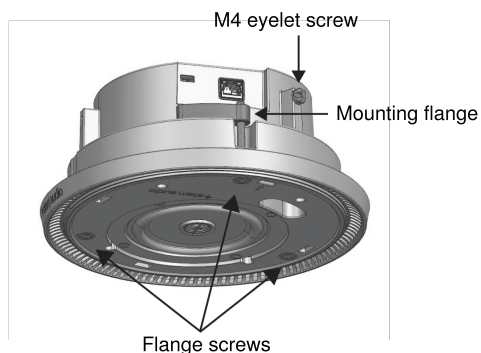

6. Keeping the flanges in line with the device, place the aluminum housing through the hole in the ceiling. If using a tile bridge, place the aluminum mounting ring over the housing, on top of the tile bridge.
7. Turn the flange screws until the device is flush against the ceiling, then hand-tighten. Do not overtighten (not to exceed a torque of 10 lb/in).
8. Align the arrows on the back of the grille and the plastic teeth inside the device, and gently press to reattach the grille.

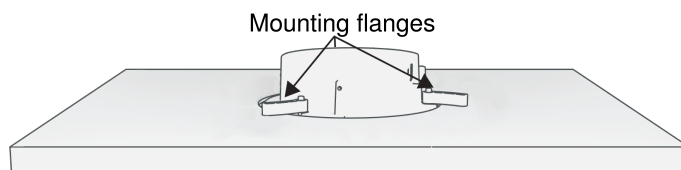

CAUTION: When installing Speaker1 into a ceiling or building structure, always use proper suspension and rigging practices in accordance with your area's building codes and regulations.

Setting Up

1. Place or mount the device in the desired location.
2. Connect the device to a network port that supports PoE+ using an Ethernet cable. *This connection provides the device with power, data, and other IoT and SIP capabilities.*
3. Install all other Stem devices, including Hub or Hub Express (required for Speaker setup), to the same network.
4. Access the Stem Ecosystem Platform to configure your devices.

Note: If your network doesn't support PoE+, you should purchase a separate PoE+ injector or PoE+ enabled switch.

For more information on setting up your room, visit shu.re/stemproductinfo or shu.re/steminstallation.

Light Indicator

Light Activity	Device Function
Slow red pulsing	Muted
Rapid red pulsing (~2 seconds)	Receiving ping
Solid red ring	Error
Slow blue pulsing	Booting up
Slow blue pulsing then off	Restarting
Blue flashing	Testing and adapting to the environment
Dim solid blue	Power on
Rapid blue pulse	Boot up completed

Stem Control

Overview

Stem Control Touch Controller is a dedicated touchscreen interface for the Stem Ecosystem Platform. Use it to remotely configure your Stem Ecosystem devices or manage calls with your favorite video conferencing platforms.

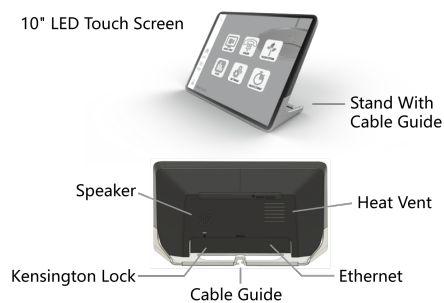

Features

What's In The Box

- CAT 6 Ethernet cable: 15 ft. (4.6 m)

Setting Up

1. Using an Ethernet cable, connect Stem Control to your Stem Ecosystem network using a port that supports PoE+. This connection provides the device with power, data, and other IoT and SIP capabilities.

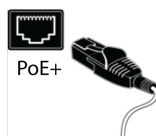

Note: If your network doesn't support PoE+, use a separate PoE+ injector or PoE+ enabled switch.

2. Complete setup using the Stem Ecosystem Platform.

Note: For more information on setting up your room, visit shu.re/stemproductinfo or shu.re/steminstallation.

Product Specifications

HUB1 Specifications

- **Frequency Response:** 50Hz – 16KHz
- **Noise Cancellation:** > 15dB (without pumping noise)
- **Weight:** 0.5 lbs. (0.23 kg)
- **Dimensions:** 7 x 1.5 in (17.8 x 3.8 cm) D x H
- **Power Consumption:** PoE+ 802.3 at Type 2
- **Operating Systems:** Windows 10 and up / Linux / MacOS 10.15 and up

Connectors

- **USB:** USB Type B
- **Ethernet:** RJ45 connector (requires PoE+)

- **Dante®:** RJ45 connector
- **Analog:** Female terminal block (for external speakers)

HUBX1 Specifications

- **Frequency Response:** 50Hz – 16KHz
- **Noise Cancellation:** > 15dB (without pumping noise)
- **Weight:** 0.5 lbs. (0.23 kg)
- **Dimensions:** 7 x 1.5 in (17.8 x 3.8 cm) D x H
- **Power Consumption:** PoE+ 802.3 at Type 2
- **Operating Systems:** Windows 10 and up / Linux / MacOS 10.15 and up

Connectors

- **USB:** USB Type B
- **Ethernet:** RJ45 connector (requires PoE+)
- **Analog:** Female terminal block (for external speakers)

WALL1 Specifications

- **Frequency response:** 50Hz – 16KHz
- **Broadcast level (peak):** 90dB SPL @ 1Khz from 1m (5 watts RMS)
- **Built-in Digital Signal Processing:**
 - **Noise cancellation:** >15dB (without pumping noise)
 - **Acoustic echo cancellation:** >40dB with conversion speed of 40dB/sec. Residual echo is suppressed to the environment noise level, preventing artificial ducking of signal.
 - Automatic voice-level adjustment (AGC)
 - 100% full duplex – no attenuation (in either direction) during full duplex
 - **High-end performance:** Conforms to ITU-T G.167.
- **Two subwoofers:** 10 watts (RMS) each
- **Two Full-Range Loudspeakers:** 4 watts (RMS) each
- **Weight:** 7.5 lbs. (3.4 kg)
- **Dimensions:** 48 x 3.5 x 3.25 (121.9 x 8.9 x 8.3 cm) L x D x H
- **Power Consumption:** PoE+ 802.3 at Type 2
- **Operating Systems:** Windows 10 and up / Linux / MacOS 10.15 and up

Connectors

- **USB:** USB Type B
- **Ethernet:** RJ45 connector (requires PoE+)

CEILING1 Specifications

- **Frequency Response:** 50Hz – 16KHz
- **Built-in Digital Signal Processing:**
 - **Noise cancellation:** >15dB (without pumping noise)
 - **Acoustic echo cancellation:** >40dB with conversion speed of 40dB/sec Residual echo is suppressed to the environment noise level, preventing artificial ducking of signal
 - Automatic voice-level adjustment (AGC)
 - 100% full duplex – no attenuation (in either direction) during full duplex
 - **High-end performance:** Conforms to ITU-T G.167.

- **Weight:**
 - **Microphone:** 9lbs. (4.1 kg)
 - **Square Mount:** 7.5 lbs. (3.4 kg)
- **Dimensions:**
 - **Microphone:** 21.5 x 1.75 in (54.6 x 4.4 cm) D x H at center; **H at edge:** 0.5 in (1.8cm)
 - **Square Mount:** 23.5 x 23.5 x 1.25 in. (59.7 x 59.7 x 3.2 cm) L x W x H
- **Power Consumption:** PoE+ 802.3 at Type 2
- **Operating Systems:** Windows 10 and up / Linux / MacOS 10.15 and up

Connections

- **USB:** USB Type B
- **Ethernet:** RJ45 connector (requires PoE+)

TABLE1 Specifications

- **Frequency Response:** 50Hz – 16KHz
- **Broadcast Level (peak):** 90dB SPL @ 1Khz from 1m (5 watts RMS)
- **Built-in Digital Signal Processing:**
 - **Noise cancellation:** >15dB (without pumping noise)
 - **Acoustic echo cancellation:** >40dB with conversion speed of 40dB/sec. Residual echo is suppressed to the environment noise level, preventing artificial ducking of signal.
 - Automatic voice-level adjustment (AGC)
 - 100% full duplex – no attenuation (in either direction) during full duplex
 - **High-end performance:** Conforms to ITU-T G.167.
- **One Loudspeaker:** 4 watts (RMS)
- **Weight:** 2.5 lbs. (1.1 kg)
- **Dimensions:** Diameter: 7.75 in. (19.7 cm) Height: 3 in. (7.6 cm)
- **Power Consumption:** PoE+ 802.3 at Type 2
- **Operating Systems:** Windows 10 and up / Linux / MacOS 10.15 and up

Connectors

- **USB:** USB Type B
- **Ethernet:** RJ45 connector (requires PoE+)

SPEAKER1 Specifications

- **Connections:** RJ45 Ethernet connector (requires PoE+)
- **Frequency response:** 80Hz – 15KHz
- **Power Consumption:** 22W (PoE+)
- **Max output level:** 85 dB SPL @ 1M
- **Weight:** 5.6 lbs. (2.5 kg)
- **Dimensions:** 9" x 4" x 4" (22.9 cm x 10.2 cm. x 10.2 cm.) H x W x D

CONTROL1 Specifications

- **Ethernet:** RJ45 connector (requires PoE+)
- **Weight:** 1.7 lbs. (0.77 kg)
- **Dimensions:** 9.6 x 5.7 x 3.7 in. (24.4 x 14.5 x 9.4 cm) W x H x D
- **Processor Multimedia:** Qualcomm® Snapdragon™ 820 Quad Core (APQ8096 SoC), QualcommKryo™ 64-bit CPU @2.2GHz each, QualcommAdreno™ 530 GPU, QualcommHexagon™ DSP 680

- **Memory / Storage:** 4GB LPDDR4, 16GB eMMC
- **Operating System:** Pre-loaded Android pie
- **Operating Temp:** 0 to 70° celsius

Display Specs

- **Screen Size:** 10.1 inch
- **Dimensions:** 229 x 149 mm (W x H)
- **Active Area:** 217 x 136 mm
- **Resolution:** 1280(RGB)×800
- **Technology Type:** a-si TFT Pixel
- **Configuration:** R.G.B. Vertical Stripe
- **Pixel pitch(mm):** 0.1695x0.1695
- **Display Mode:** TM, Normally Black
- **Surface Treatment:** HC

IMPORTANT SAFETY INSTRUCTIONS

1. READ these instructions.
2. KEEP these instructions.
3. HEED all warnings.
4. FOLLOW all instructions.
5. DO NOT use this apparatus near water.
6. CLEAN ONLY with dry cloth.
7. DO NOT block any ventilation openings. Allow sufficient distances for adequate ventilation and install in accordance with the manufacturer's instructions.
8. DO NOT install near any heat sources such as open flames, radiators, heat registers, stoves, or other apparatus (including amplifiers) that produce heat. Do not place any open flame sources on the product.
9. DO NOT defeat the safety purpose of the polarized or grounding type plug. A polarized plug has two blades with one wider than the other. A grounding type plug has two blades and a third grounding prong. The wider blade or the third prong are provided for your safety. If the provided plug does not fit into your outlet, consult an electrician for replacement of the obsolete outlet.
10. PROTECT the power cord from being walked on or pinched, particularly at plugs, convenience receptacles, and the point where they exit from the apparatus.
11. ONLY USE attachments/accessories specified by the manufacturer.
12. USE only with a cart, stand, tripod, bracket, or table specified by the manufacturer, or sold with the apparatus. When a cart is used, use caution when moving the cart/apparatus combination to avoid injury from tip-over.





13. UNPLUG this apparatus during lightning storms or when unused for long periods of time.
14. REFER all servicing to qualified service personnel. Servicing is required when the apparatus has been damaged in any way, such as power supply cord or plug is damaged, liquid has been spilled or objects have fallen into the apparatus, the apparatus has been exposed to rain or moisture, does not operate normally, or has been dropped.
15. DO NOT expose the apparatus to dripping and splashing. DO NOT put objects filled with liquids, such as vases, on the apparatus.
16. The MAINS plug or an appliance coupler shall remain readily operable.

17. The airborne noise of the Apparatus does not exceed 70dB (A).
18. Apparatus with CLASS I construction shall be connected to a MAINS socket outlet with a protective earthing connection.
19. To reduce the risk of fire or electric shock, do not expose this apparatus to rain or moisture.
20. Do not attempt to modify this product. Doing so could result in personal injury and/or product failure.
21. Operate this product within its specified operating temperature range.
22. Follow local regulations and consult qualified personnel if the product installation or relocation requires construction work. Choose mounting hardware and an installation location that can support the weight of the product. Avoid locations subject to constant vibration. Use the required tools to install the product properly. Inspect the product periodically.

WARNING: Voltages in this equipment are hazardous to life. No user-serviceable parts inside. Refer all servicing to qualified service personnel. The safety certifications do not apply when the operating voltage is changed from the factory setting.

SAFETY PRECAUTIONS

The possible results of incorrect use are marked by one of the two symbols—"WARNING" and "CAUTION"—depending on the imminence of the danger and the severity of the damage.

	WARNING: Ignoring these warnings may cause severe injury or death as a result of incorrect operation.
	CAUTION: Ignoring these cautions may cause moderate injury or property damage as a result of incorrect operation.

Important Product Information

Shure has determined that this product is a Class A harmonized product. The following sections provide country-specific EMC/EMI or product safety information.

Warning: This is a Class A product. In a domestic environment this product may cause radio interference in which case the user may be required to take adequate measures.

The equipment is intended to be used in professional audio applications.

This device is to be connected only to PoE networks without routing to the outside plant.

Note: This device is not intended to be connected directly to a public internet network.

Changes or modifications not expressly approved by Shure Incorporated could void your authority to operate this equipment.

EMC conformance testing is based on the use of supplied and recommended cable types. The use of other cable types may degrade EMC performance.

Waste Electrical and Electronic Equipment (WEEE) Directive



In the European Union and the United Kingdom, this label indicates that this product should not be disposed of with household waste. It should be deposited at an appropriate facility to enable recovery and recycling.

Registration, Evaluation, Authorization of Chemicals (REACH) Directive

REACH (Registration, Evaluation, Authorization of Chemicals) is the European Union (EU) and the United Kingdom (UK) chemical substances regulatory framework. Information on substances of very high concern contained in Shure products in a concentration above 0.1% weight over weight (w/w) is available upon request.

Please consider the environment, electric products and packaging are part of regional recycling schemes and do not belong to regular household waste.

Information to the user

This product has been tested and found to comply with the limits for a Class A digital device pursuant to Part 15 of the FCC Rules. These limits are designed to provide reasonable protection against harmful interference when the equipment is operated in a commercial environment. This product generates, uses, and can radiate radio frequency energy and, if not installed and used in accordance with the manufacturer's instruction manual, may cause harmful interference with radio communications. Operation of this product in a residential area is likely to cause harmful interference, in which case you will be required to correct the interference at your own expense.

This device complies with Part 15 of the FCC Rules. Operation is subject to the following two conditions:

1. This device may not cause harmful interference.
2. This device must accept any interference received, including interference that may cause undesired operation.

Notice: The FCC regulations provide that changes or modifications not expressly approved by Shure Incorporated could void your authority to operate this equipment.

These limits are designed to provide reasonable protection against harmful interference in a non-residential installation. However, there is no guarantee that interference will not occur in a particular installation. If this equipment does cause harmful interference with radio or television reception, which can be determined by turning the equipment off and on, you are encouraged to try to correct the interference by one or more of the following measures:

- Reorient or relocate the antenna of the radio/television receiver.
- Increase the separation between this equipment and the radio/television receiver.
- Plug the equipment into a different outlet so that the equipment and the radio/television receiver are on different power mains branch circuits.
- Consult a representative of Shure or an experienced radio/television technician for additional suggestions.

LIMITED WARRANTY

Shure Incorporated ("Shure") hereby warrants to the original consumer purchaser only that, except as otherwise specified below, this product will be free in normal use of any defects in materials and workmanship for a period of two (2) years from the consumer's original date of purchase directly from Shure or from a Shure-authorized reseller.

Any rechargeable batteries contained in or packaged with this product are so warranted for a period of one (1) year from the consumer's original date of purchase. However, rechargeable batteries are consumable and their capacity will be reduced over time based on temperature, amount of time in storage, charging cycles, and other factors; hence reduction in battery capacity does not constitute a defect in material or workmanship.

At its sole option, Shure will repair or replace the defective product and promptly return it to you. In order for this warranty to be valid, the consumer must, at the time the product is returned, provide proof of purchase in the form of the original purchase receipt directly from Shure or from a Shure-authorized reseller. If Shure elects to replace the defective product, then Shure reserves the right to replace the defective product with another product of the same model or a model of at least comparable quality and features in Shure's sole determination.

If you believe this product is defective within the warranty period, carefully repack the unit, insure it and return it with proof of purchase, postage prepaid, to Shure Incorporated, Attention: Service Department, at the address below.

Outside of the United States, return the product to your dealer or Authorized Service Center. Addresses are listed on www.Shure.com or can be obtained by contacting Shure at the address listed below.

This warranty is not transferable. This warranty does not apply in cases of abuse or misuse of the product, use contrary to Shure's instruction, ordinary wear and tear, an act of God, negligent use, purchase from a party other than Shure or a Shure-authorized reseller, unauthorized repair, or modification of the product.

ALL IMPLIED WARRANTIES OF MERCHANTABILITY OR FITNESS FOR A PARTICULAR PURPOSE ARE HEREBY DISCLAIMED TO THE EXTENT PERMITTED UNDER APPLICABLE LAWS AND, TO THE EXTENT NOT PERMITTED, ARE

HEREBY LIMITED TO THE DURATION AND TERMS OF THIS WARRANTY. SHURE ALSO HEREBY DISCLAIMS ALL LIABILITY FOR INCIDENTAL, SPECIAL, OR CONSEQUENTIAL DAMAGES.

Some states do not allow limitations on how long an implied warranty lasts, or the exclusion or limitation of incidental or consequential damages, so the above limitation may not apply to you. This warranty gives you specific legal rights, and you may have other rights which vary from state to state.

This warranty does not restrict the rights of the consumer mandated under applicable laws.

THIS WARRANTY SUPERSEDES ALL OTHER WARRANTIES THAT ARE ASSOCIATED OR INCLUDED WITH THIS PRODUCT, EXCEPT THAT ANY SOFTWARE CONTAINED IN OR PACKAGED WITH THIS PRODUCT IS EXCLUDED FROM THIS WARRANTY AND INSTEAD SHALL BE COVERED BY THE WARRANTY, IF ANY, PROVIDED IN SHURE'S END USER LICENSE AGREEMENT ACCOMPANYING SUCH SOFTWARE.

FOR ORIGINAL PURCHASES IN AUSTRALIA ONLY

LIMITED WARRANTY AGAINST DEFECTS

Shure Incorporated ("Shure") hereby warrants to the original consumer purchaser in Australia only that, except as otherwise specified below, this product will be free in normal use of any defects in materials and workmanship for a period of two (2) years from the consumer's original date of purchase directly from Shure or from a Shure-authorized reseller.

Any rechargeable batteries contained in or packaged with this product are so warranted for a period of one (1) year from the consumer's original date of purchase. However, rechargeable batteries are consumable and their capacity will be reduced over time based on temperature, amount of time in storage, charging cycles, and other factors; hence reduction in battery capacity does not constitute a defect in material or workmanship.

At its sole option, Shure will repair or replace the defective product and promptly return it to you. In order for this warranty to be valid, the consumer must, at the time the product is returned, provide proof of purchase in the form of the original purchase receipt directly from Shure or from a Shure-authorized reseller. If Shure elects to replace the defective product, then Shure reserves the right to replace the defective product with another product of the same model or a model of at least comparable quality and features in Shure's sole determination.

If you believe this product is defective within the warranty period, carefully repack the unit, insure it and return it with proof of purchase, postage prepaid, to Shure Incorporated, Attention: Service Department, at the address below.

Outside of the United States, return the product to your dealer or Authorized Service Center. Addresses are listed on www.Shure.com or can be obtained by contacting Shure at the address listed below.

This warranty is not transferable. This warranty does not apply in cases of abuse or misuse of the product, use contrary to Shure's instruction, ordinary wear and tear, an act of God, negligent use, purchase from a party other than Shure or a Shure-authorized reseller, unauthorized repair, or modification of the product.

ALL IMPLIED WARRANTIES OF MERCHANTABILITY OR FITNESS FOR A PARTICULAR PURPOSE ARE HEREBY DISCLAIMED TO THE EXTENT PERMITTED UNDER APPLICABLE LAWS AND, TO THE EXTENT NOT PERMITTED, ARE HEREBY LIMITED TO THE EXTENT PERMITTED TO THE DURATION AND TERMS OF THIS WARRANTY. SHURE ALSO HEREBY DISCLAIMS ALL LIABILITY FOR INCIDENTAL, SPECIAL, OR CONSEQUENTIAL DAMAGES FOR ANY PURCHASER ACQUIRING THIS PRODUCT, EXCEPT THAT THIS DOES NOT CONSTITUTE A DISCLAIMER OF RIGHTS GUARANTEED TO ANY "CONSUMER" UNDER THE AUSTRALIAN CONSUMER LAW.

This warranty gives purchasers of this product in Australia specific legal rights which are in addition to the rights and remedies of consumers under the Australian Consumer Law, which cannot be excluded or limited. If you are a "consumer" under the Australian Consumer Law, you are entitled to a replacement or refund for a major failure and for compensation for any other reasonably foreseeable loss or damage. You are also entitled to have the goods repaired or replaced if the goods fail to be of acceptable quality and the failure does not amount to a major failure.

THIS WARRANTY SUPERSEDES ALL OTHER WARRANTIES THAT ARE ASSOCIATED OR INCLUDED WITH THIS PRODUCT, EXCEPT THAT ANY SOFTWARE CONTAINED IN OR PACKAGED WITH THIS PRODUCT IS EXCLUDED FROM THIS WARRANTY AND INSTEAD SHALL BE COVERED BY THE WARRANTY, IF ANY, PROVIDED IN SHURE'S END USER LICENSE AGREEMENT ACCOMPANYING SUCH SOFTWARE.

Service Centers

United States, Canada, Latin America, Caribbean

Shure Incorporated
Attn: Service Department
945 Chaddick Dr.
Wheeling, IL 60090-6449 U.S.A.

Europe, Middle East, and Africa

Shure Europe GmbH
Attn: Service
Jakob-Dieffenbacher-Str. 12,
75031 Eppingen, Germany

Indonesia Service Center Resmi:

Jakarta Hotline (021) 612 6388
Medan (061) 6612550
Surabaya (031) 5032219
Jogjakarta (0274) 371710
Denpasar (0361) 766788
Makasar (0411) 324652

Need Some Help?

Website: shure.com/stem

Email: customerhappiness@shure.com

Telephone: (949) 877-STEM (7836)

Setup Videos: youtube.com/shuresystems

Product Guides: shu.re/stemproductinfo

Additional Installation Resources: shu.re/steminstallation

