

# SR18S

OWNER'S MANUAL



## Important Safety Instructions

1. Read these instructions.
2. Keep these instructions.
3. Heed all warnings.
4. Follow all instructions.
5. Do not use this apparatus near water.
6. Clean only with a dry cloth.
7. Do not block any ventilation openings. Install in accordance with the manufacturer's instructions.
8. Minimum distance (5 cm) around the apparatus for sufficient ventilation. The ventilation should not be impeded by covering the ventilation openings with items, such as newspapers, table-cloths, curtains, etc.
9. Do not install near any heat sources such as radiators, heat registers, stoves, or other apparatus (including amplifiers) that produce heat.
10. No naked flame sources, such as lighted candles, should be placed on the apparatus.
11. Do not defeat the safety purpose of the polarized or grounding-type plug. A polarized plug has two blades with one wider than the other. A grounding-type plug has two blades and a third grounding prong. The wide blade or the third prong are provided for your safety. If the provided plug does not fit into your outlet, consult an electrician for replacement of the obsolete outlet.
12. Protect the power cord from being walked on or pinched particularly at plugs, convenience receptacles, and the point where they exit from the apparatus.
13. Only use attachments/accessories specified by the manufacturer.
14. Use only with a cart, stand, tripod, bracket, or table specified by the manufacturer, or sold with the apparatus. When a cart is used, use caution when moving the cart/apparatus combination to avoid injury from tip-over.
15. Unplug this apparatus during lightning storms or when unused for long periods of time.
16. Refer all servicing to qualified service personnel. Servicing is required when the apparatus has been damaged in any way, such as power-supply cord or plug is damaged, liquid has been spilled or objects have fallen into the apparatus, the apparatus has been exposed to rain or moisture, does not operate normally, or has been dropped.
17. This apparatus shall not be exposed to dripping or splashing, and no object filled with liquids, such as vases or beer glasses, shall be placed on the apparatus.
18. Do not overload wall outlets and extension cords as this can result in a risk of fire or electric shock.



19.  This apparatus has been designed with Class-I construction and must be connected to a mains socket outlet with a protective earthing connection (the third grounding prong).
20. This apparatus has been equipped with a rocker-style AC mains power switch. This switch is located on the rear panel and should remain readily accessible to the user.
21. The MAINS plug or an appliance coupler is used as the disconnect device, so the disconnect device shall remain readily operable.
22. The use of apparatus is in tropical and/or moderate climates.
23. **NOTE:** This equipment has been tested and found to comply with the limits for a Class A digital device, pursuant to part 15 of the FCC Rules. These limits are designed to provide reasonable protection against harmful interference when the equipment is operated in a commercial environment. This equipment generates, uses, and can radiate radio frequency energy and, if not installed and used in accordance with the instruction manual, may cause harmful interference to radio communications. Operation of this equipment in a residential area is likely to cause harmful interference in which case the user will be required to correct the interference at his own expense.  
**WARNING:** Operation of SR18S in a residential environment could cause radio interference.  
**CAUTION:** Changes or modifications to this device not expressly approved by LOUD Audio, LLC could void the user's authority to operate the equipment under FCC rules.
24. This apparatus does not exceed the Class A/Class B (whichever is applicable) limits for radio noise emissions from digital apparatus as set out in the radio interference regulations of the Canadian Department of Communications.  
**ATTENTION** — *Le présent appareil numérique n'émet pas de bruits radioélectriques dépassant les limites applicables aux appareils numériques de class A/de class B (selon le cas) prescrites dans le règlement sur le brouillage radioélectrique édicté par les ministere des communications du Canada.*
25. Exposure to extremely high noise levels may cause permanent hearing loss. Individuals vary considerably in susceptibility to noise-induced hearing loss, but nearly everyone will lose some hearing if exposed to sufficiently intense noise for a period of time. The U.S. Government's Occupational Safety and Health Administration (OSHA) has specified the permissible noise level exposures shown in the following chart.

According to OSHA, any exposure in excess of these permissible limits could result in some hearing loss. To ensure against potentially dangerous exposure to high sound pressure levels, it is recommended that all persons exposed to equipment capable of producing high sound pressure levels use hearing protectors while the equipment is in operation. Ear plugs or protectors in the ear canals or over the ears must be worn when operating the equipment in order to prevent permanent hearing loss if exposure is in excess of the limits set forth here:

Duration, per day in hours	Sound Level dBA, Slow Response	Typical Example
8	90	Duo in small club
6	92	
4	95	Subway Train
3	97	
2	100	Very loud classical music
1.5	102	
1	105	Matt screaming at Troy about deadlines
0.5	110	
0.25 or less	115	Loudest parts at a rock concert





**CAUTION**

RISK OF ELECTRIC SHOCK! DO NOT OPEN!



CAUTION: TO REDUCE THE RISK OF ELECTRIC SHOCK DO NOT REMOVE COVER (OR BACK). NO USER-SERVICEABLE PARTS INSIDE. REFER SERVICING TO QUALIFIED PERSONNEL.

 The lightning flash with arrowhead symbol within an equilateral triangle is intended to alert the user to the presence of uninsulated "dangerous voltage" within the product's enclosure, that may be of significant magnitude to constitute a risk of electric shock to persons.

 The exclamation point within an equilateral triangle is intended to alert the user of the presence of important operating and maintaining (servicing) instructions in the literature accompanying the appliance.

**WARNING** — To reduce the risk of fire or electric shock, do not expose this apparatus to rain or moisture.

**CAUTION** — To prevent electric shock hazard, do not connect to mains power supply while grille is removed.

Laitte on liitettävä suojakoskettimilla varustettuun pistorasiaan.

Apparatet stikprop skal tilsluttes en stikkontakt med jord, som giver forbindelse til stikproppens jord.

Apparatet må tilkoples jordet stikkontakt.

Apparaten skall anslutas till jordat uttag.



**Correct disposal of this product:** This symbol indicates that this product should not be disposed of with your household waste, according to the WEEE directive (2012/19/EU) and your national law. This product should be handed over to an authorized collection site for recycling waste electrical and electronic equipment (EEE). Improper handling of this type of waste could have a possible negative impact on the environment and human health due to potentially hazardous substances that are generally associated with EEE. At the same time, your cooperation in the correct disposal of this product will contribute to the effective usage of natural resources. For more information about where you can drop off your waste equipment for recycling, please contact your local city office, waste authority, or your household waste disposal service.

## Contents

Important Safety Instructions .....	2
Contents .....	3
Features.....	3
Introduction .....	4
Getting Started .....	4
Hookup Diagrams .....	5
<b>SR18S Subwoofer: Rear Panel Features.....</b>	<b>9</b>
1. Power Connection .....	9
2. Power Switch.....	9
3. XLR Inputs .....	9
4. High-Pass Outputs .....	9
5. Full Range Outputs.....	10
6. High Pass Mode.....	10
7. Front LED Switch .....	10
8. Gain Knob and Sig/Clip LED .....	10
9. FR Output Switch .....	10
10. Normal/Invert Switch [Phase] .....	11
<b>The Ins and Outs of Polarity.....</b>	<b>11</b>
<b>Placement .....</b>	<b>11</b>
<b>Protection Circuitry.....</b>	<b>12</b>
Limiting .....	12
Overexcursion Protection.....	12
Thermal Protection .....	12
<b>AC Power .....</b>	<b>12</b>
<b>Care and Maintenance .....</b>	<b>12</b>
<b>Pairing an SRT loudspeaker w/the SR18S subwoofer ....</b>	<b>13</b>
<b>Appendix A: Service Information.....</b>	<b>14</b>
<b>Appendix B: Technical Information .....</b>	<b>15</b>
SR18S Magnitude Response Graph.....	16
SR18S Dimensions .....	16
SR18S Block Diagram .....	17
<b>Limited Warranty .....</b>	<b>18</b>

## Features

### A True Workhorse for Gigging Professionals

- 1600W Class-D amplifier is designed for ultra-reliable, consistent performance
- Custom high-efficiency transducer ensures maximum punch
- Increases efficiency of your full-range loudspeakers by taking care of the low end for the entire system
- Built-Like-A-Tank™ to conquer every gig while lightweight for easy loading
- Frequency response: 33 Hz – 200 Hz
- Max SPL: 133 dB

### Custom Voicing Presets

- Flat – Natural balance between deep bass and overall output
- Deep – Emphasizes ultra-low frequencies. Great for dance, rap, and electronic music
- Punch – Prioritizes highest possible output level. Great for bands and rock music

### Optimize for Your System

- Variable crossover frequency
- Polarity invert switch
- Defeatable front LED
- Stereo or mono-summing for single or dual subwoofer deployment
- Variable level control (-6 dBU to +6 dBU)

### Transparent System Limiting and Protection

- Dedicated processing module monitors and protects the amplifier in real time
- Sound quality and tonal balance is maintained even under heavy limiting
- Input limiting keeps your source signal in check so if you're sending audio that's a bit too hot, the speaker will cool it down
- Universal Power Supply (100 – 240VAC) with Power Factor Correction for stable operation even with unstable AC power

### Versatile I/O

- Stereo XLR inputs
- Stereo full-range XLR outputs
- Stereo high-pass XLR outputs

### Versatile configuration options

- Integrated pole cup

**Weight: 74.5 lb / 33.8 kg**

**Dimensions: 23.3 x 23.0 x 27.0 in / 592 x 584 x 686 mm**

## Introduction

The SR18S 18" 1600W Professional Powered Subwoofer is designed for real-world working musicians, DJs, events, venues, and beyond.

The latest acoustic processing technology, powerful amplification, and versatile configurations deliver incredible sound and unbeatable reliability. Custom Voicing modes and a variable crossover makes optimization for your system easy.

Built-Like-A-Tank™ construction features a rugged wood cabinet and tough steel grille that is built to last.

A perfect complement to the SRT Series, SRM | V-Class Series or any PA, SR18S not only adds powerful low end, but allows for a massive increase in efficiency and output for your whole system.

### How to Use This Manual:

After this introduction, a getting started guide will help you get things set up fast. The hookup diagrams show some typical SR18S subwoofer setups.



This icon marks information that is critically important or unique! For your own good, read and remember them...it is a good idea to pay special attention to these areas in the Owner's Manual marked with the "VERY IMPORTANT" hand icon.



There's an illustration of a microscope, so, of course, you're going to get more detailed information when you see this little guy. There are explanations of features and practical tips listed here.



It's a good idea to pay attention to text displayed next to a note icon, as this icon draws attention to certain features and functions relating to the usage of the SR18S.

**Please write the serial numbers here for future reference (i.e., insurance claims, tech support, return authorization, make dad proud, etc.)**

**Purchased at:**

**Date of purchase:**

## Getting Started

The following steps will help you set up the SR18S quickly. If using SRT Series loudspeakers, please refer to page 13.

1. Make all initial connections with the power switches OFF on all equipment. Make sure the master volume, level and gain controls are all the way down.
2. Connect the outputs from the mixing console (or other signal source) to the inputs of the SR18S, then connect the high pass outputs from the subwoofer to the inputs of the loudspeakers.
3. Make sure the subwoofer's and loudspeaker's gain knobs are set to "U" (unity gain).
4. Push the line cord securely into the subwoofer's / loudspeaker's IEC connectors and plug the other ends into grounded AC outlets. The subwoofer/loudspeaker may accept the appropriate voltage as indicated near the IEC connector.
5. Break into your favorite dance routine.
6. Turn the mixer (or other signal source) on.
7. Turn the subwoofer on.
8. Turn the loudspeakers on.
9. Start the signal source and raise the mixer's main L/R fader up to a comfortably loud listening level.

### Things to Remember:

- Never listen to loud music for prolonged periods. Please see the Safety Instructions on page 2 for information on hearing protection.
- As a general guide, the mixer (or other signal source) should be turned on first, SR18S subwoofer next, and loudspeakers last. As such, the loudspeakers should also be turned off first, followed by the SR18S, then the mixer. This will reduce the possibility of any turn-on or turn-off thumps and other noises generated by any upstream equipment from coming out of the speakers.
- Save the shipping boxes and packing materials! You may need them someday. Besides, the cats will love playing in them and jumping out at you unexpectedly. Remember to pretend like you are surprised!
- Save your sales receipt in a safe place.

## Hookup Diagrams

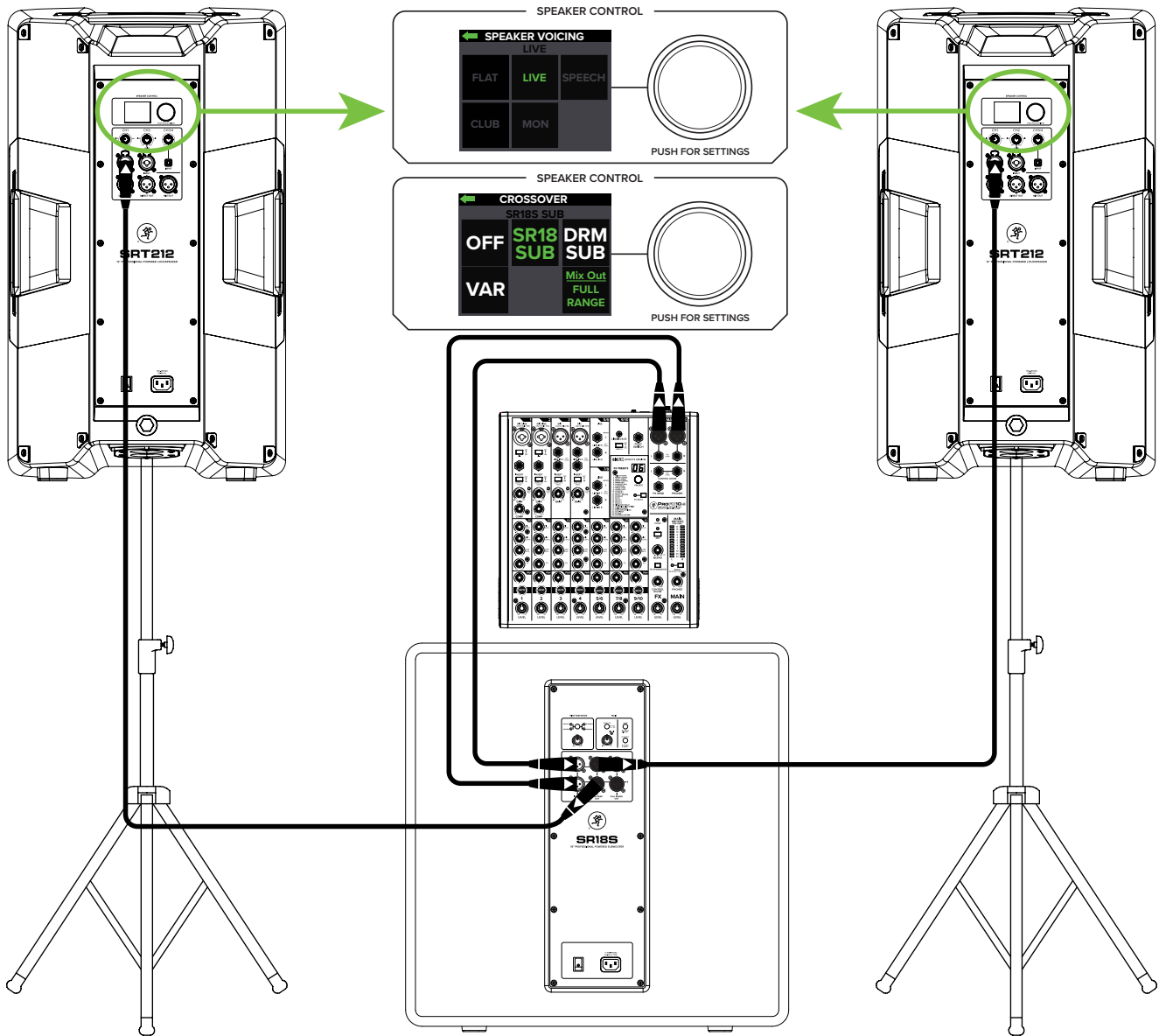

In this example, a ProFX10v3 mixer is connected directly to an SR18S subwoofer which, in turn, is connected to a pair of SRT212 loudspeakers. It is the perfect setup for a small club or... a totally happenin' karaoke house party! Simply connect the L/R outputs of a ProFX10v3 mixer directly to the A and B inputs of the SR18S subwoofer. Then the High-Pass Outs of the subwoofer are connected to the channel 1 inputs of a pair of SRT212 loudspeakers. The gain knob on both should be set to Line. Here you will want to set the Speaker Mode to either Live or Club and the Subwoofer HPF to SR18S Sub.

### Small Club System

## Hookup Diagrams continued...

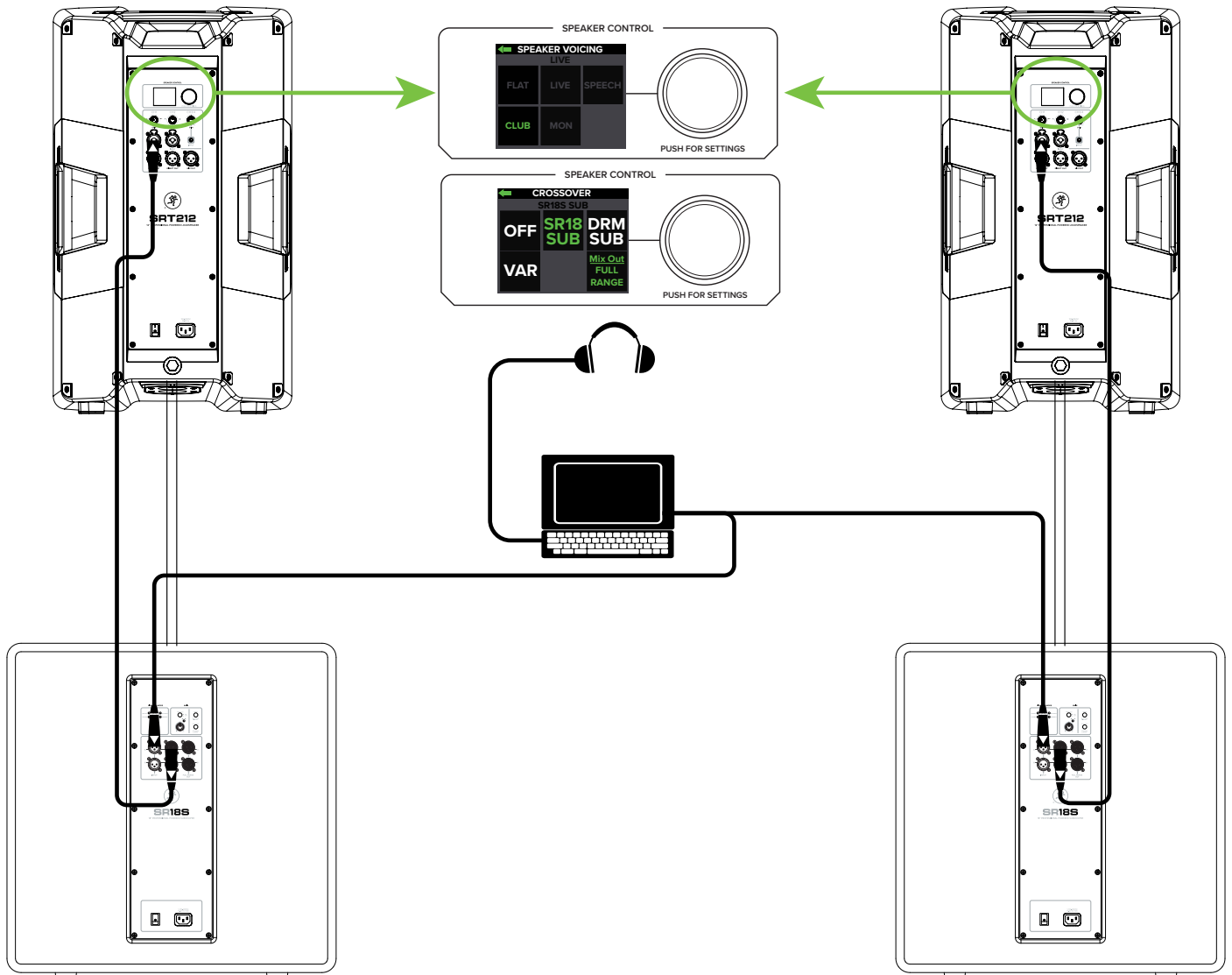

Perhaps you're a DJ playing bumpin' tunes in the middle of the night to a crowd that's groovin' and dancin' to your fine selection.

In this example, a laptop is connected to the inputs of two SR18S subwoofers.

The High-Pass Out of each subwoofer is then connected to the input of each SRT212 loudspeaker. Additionally, a set of Mackie MC-450 headphones is connected to the phones jack of the laptop.

The Speaker Modes of both loudspeakers may be set to Club and the Subwoofer HPF set to SR18S Sub.

### DJ System

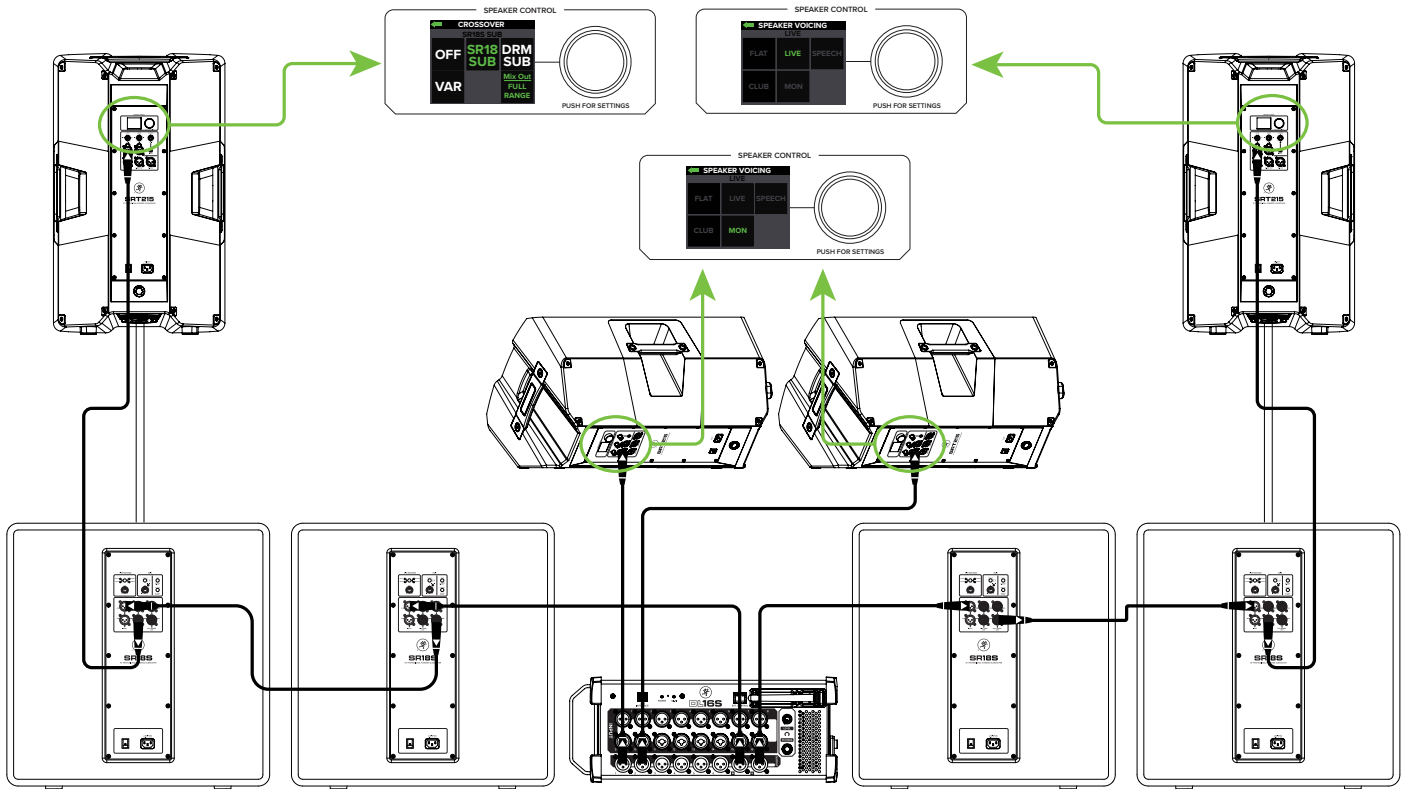

Here's how to set up a large club system. In this example, the L/R outputs of a DL16S mixer are connected directly to the channel 1 inputs of a pair of SR18S subwoofers. The Full Range Out of each subwoofer is then connected to the inputs of an additional pair of SR18S subwoofers.

From here, the High Pass Out of the two outer SR18S subwoofers are connected directly to the inputs of a set of SRT215 loudspeakers. The Speaker Modes of these PA loudspeakers may be set to Live (or Club) and the Subwoofer HPF set to SR18S Sub. Talk about beefy low end!

Outputs 1 and 2 from the mixer may be used as aux sends; these are connected directly to the channel 1 inputs of a pair of SRT215 loudspeakers to be used as monitors for the band. The gain knob on all SRT215 loudspeakers in this example should be set to Line. The Speaker Modes of the monitor loudspeakers may be set to Monitor.

## Large Club System



## Hookup Diagrams continued...

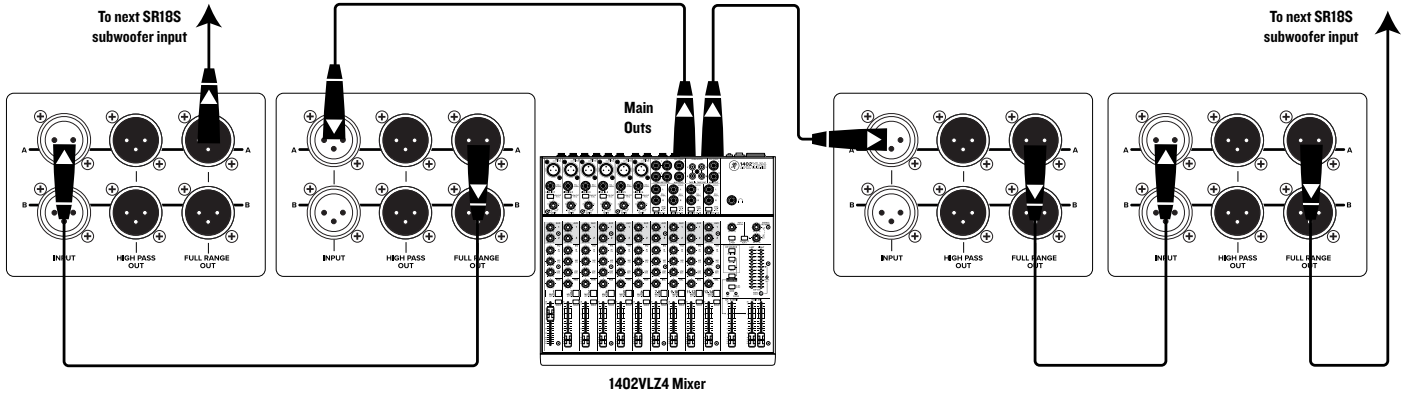

SR18S subwoofers may be daisy-chained via the male XLR connector labeled "FULL RANGE OUT". Simply plug the signal source (i.e., mixer output) into the ch. 1 input jack(s), and patch that subwoofer's full range out jack to the next subwoofer's input jack, and so on, daisy-chaining multiple SR18S subwoofers. See above for visual representations of daisy-chaining.

### Daisy-Chaining Multiple SR18S Subwoofers



# SR18S Subwoofer: Rear Panel Features

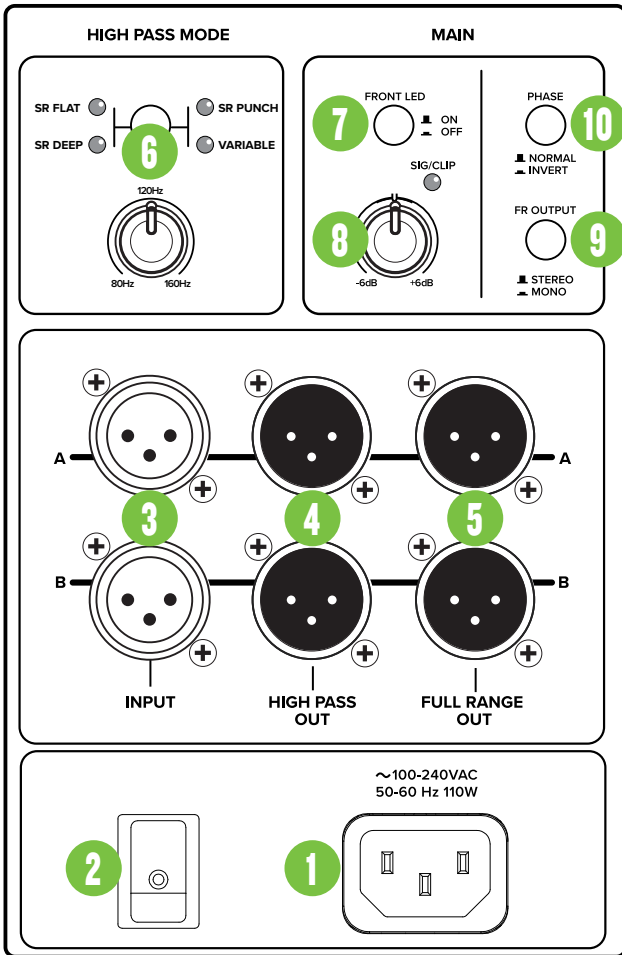

## 1. Power Connection

This is a standard 3-prong IEC power connector. Connect the detachable power cord (included in the packaging with the subwoofer) to the power receptacle, and plug the other end of the power cord into an AC outlet.

**VERY IMPORTANT** Make sure that the AC power is matched to the AC power indicated on the rear panel (below the IEC receptacle).

**VERY IMPORTANT** Disconnecting the plug's ground pin is dangerous. Don't do it!

## 2. Power Switch

Press the top of this rocker switch inwards to turn on the subwoofer. Press the bottom of this rocker switch inwards to turn off the subwoofer.

**VERY IMPORTANT** As a general guide, the mixer (or other signal source) should be turned on first, subwoofers next, and loudspeakers last. As such, the loudspeakers should also be turned off first, followed by the subwoofers, then the mixer. This will reduce the possibility of any turn-on or turn-off thumps and other noises generated by any upstream equipment from coming out of the speakers.

## 3. XLR Inputs

Balanced XLR female connectors are provided for the left and right inputs. Connect the full-range line-level signal from the mixer (or other signal source) to these input jacks.

If you are connecting a single subwoofer output, or LFE (low-frequency effects) output to the subwoofer, you may use either the A or B input connector.

**VERY IMPORTANT** NEVER connect the output of an amplifier directly to the input of the subwoofer. This could damage the input circuitry of the active subwoofer.

### XLR Balanced Input Connector:

- Pin 1 = Shield (ground)
- Pin 2 = Positive (+ or hot)
- Pin 3 = Negative (- or cold)

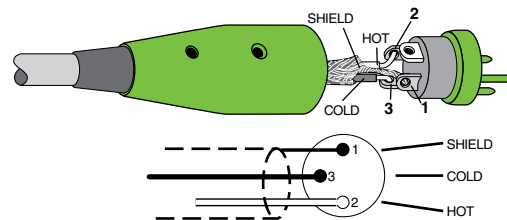

## 4. High Pass Outputs

Typically, full-range loudspeakers are connected to the high pass outputs to "split" the work with the SR18S subwoofer. The subwoofer handles all of the low frequencies and the loudspeakers handle the rest. As a result, it is more efficient and a bit louder.

Balanced XLR male connectors are provided for the line-level Ch. A and B high pass outputs. The subwoofer's crossover splits the input signals into two frequency bands. The low frequency range below 140 Hz goes to the internal amplifier that powers the subwoofer. The frequency range above 140 Hz is sent to these line-level output jacks.

The level control and polarity setting have no effect on the high pass outputs. The outputs are separate and maintain the stereo separation of the input signals.

They are wired as follows, according to standards specified by the AES (Audio Engineering Society):

### Balanced XLR Output Connector

- Pin 1 – Shield (ground)
- Pin 2 – Positive (+ or hot)
- Pin 3 – Negative (- or cold)

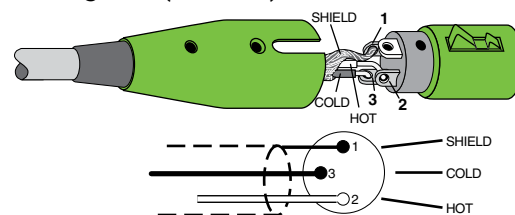

See the previous page to learn more about daisy-chaining SR18S subwoofers.

## SR18S Subwoofer: Rear Panel Features continued...

### 5. Full Range Outputs

Connect the full range outputs to the inputs of another powered subwoofer, powered loudspeakers, or to an amplifier powering passive loudspeakers. Balanced XLR male connectors are provided for the line-level A and B full range outputs.

The signal at these outputs is a direct copy of the input signals. These outputs allow you to daisy-chain multiple subwoofers and/or send the full range signals to other loudspeakers. It's a great way to add side fills, too!

It is wired the same as the high pass outputs as seen on the previous page.

### 6. High Pass Mode

The high pass mode allows you to optimize the behavior of the SR18S subwoofer and loudspeakers connected to its high pass outputs. These modes are sequentially accessible, cycled by pressing the High Pass Mode button.

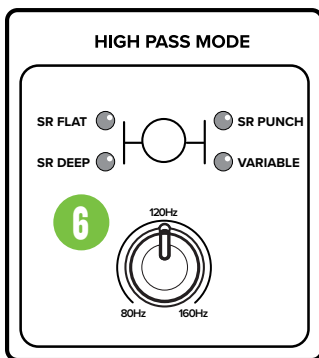

When using SRT loudspeakers, proprietary DSP is employed to transform the subwoofer and attached top boxes into an acoustically optimized 3-way system. These modes shape the output of the subwoofer while simultaneously

controlling the gain and high pass of the signal sent to the top boxes. There are three separate options, depending on intended use case:

- **SR Flat [Default]** – This factory default setting delivers nice, balanced bass, suitable for all music types.
- **SR Deep** – SR Deep trades a bit of output for much deeper bass extension. This mode pairs well with electronic music, or for use with electronic keyboards.
- **SR Punch** – SR Punch has opposite shaping of SR Deep. It delivers a higher peak SPL at the expense of LF extension, while still maintaining musicality. Optimized for use with live music.

All three of these settings may be used interchangeably with SRT 10", 12", and 15" models. Utilizing the SR High Pass Modes with non-SRT top boxes may result in incorrect top box performance and is not recommended.



The adjustment knob is fully bypassed when any SR mode is engaged.

If not using SRT Loudspeakers, the Variable High Pass Mode allows you to select a customizable high pass frequency for your top boxes, adjustable between 80 Hz to 160 Hz. The High Pass Mode knob is active while in "Var" mode.

### 7. Front LED Switch

There is a single horizontal LED bar located near the bottom-front of each SR18S subwoofer. Here is where you decide if you want the front LED on or off.

- **On [Default]** – The LED illuminates in all its glory.
- **Off** – The LED does not illuminate; it is turned off and the SR18S operates in 'stealth' mode.

### 8. Gain Knob and Sig/Clip LED

The gain knob adjusts the sensitivity of the inputs. This allows signals from the outside world to be adjusted to run through each channel at optimal internal operating levels. There is -6 dB of gain with the knob fully down (off), ramping up to +6 dB of gain fully up (max).

The accompanying dual-colored LED will illuminate green when the input signal is present, indicating signal. It will remain lit so long as there is signal above -20 dBu present.

SR18S subwoofers have a built-in limiter that helps to prevent the amplifier outputs from clipping or overdriving the transducers. The LED illuminates red when the limiter is activated. It's okay for it to blink red occasionally, but if it blinks frequently or lights continuously, turn down the gain knob until it only blinks occasionally.



Excessive limiting may lead to overheating, which in turn trips the thermal protect circuitry and interrupts the performance. See 'Thermal Protection' on page 12 for more information.

### 9. FR Output Switch

This switch allows you to choose whether the A and B inputs are sent out separately [switch out] or as a mono sum of both inputs [switch in] via the full range outputs.

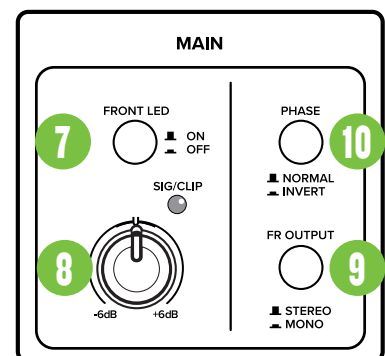

This is useful and saves the hassle of additional cable runs when connecting multiple (mono) subwoofers. Instead of running two cables from the first subwoofer to the next one, simply engage the switch and the signals from both inputs are combined on either full range output.

## 10. Normal/Invert Switch [Phase]

This switch reverses the polarity of the signal going into the subwoofer amplifier by 180°. It has no effect on the signal at the outputs.

There is no right or wrong setting for this switch. Listen to the overall blend of the subwoofer with the rest of the system and select the switch position that gives you the best sound for your audience. In fact, your system may vary when positioned differently and in alternate venues. Don't be afraid to experiment with the position of the polarity switch. See the following page for more information.

### The Ins and Outs of Polarity

SR18S subwoofers include a switch that allows you to quickly invert the polarity of the subwoofer's output relative to the input signal it is receiving from the mixer or other sound source. But what exactly does that mean? A subwoofer works by literally pumping air as the woofer cone moves in and out with respect to the cabinet in which it is housed. It does so according to the low-frequency portion of the signal it receives from the sound source.

The woofer cone is simply following the waveform as seen in the sine wave in Figure 1. As the sine wave rises, the woofer cone pushes out. Likewise, as the sine wave falls, the woofer cone pulls into the cabinet. A musical signal is much more complex, of course, but the same principle applies. Movement of the woofer cone causes air pressure changes that we perceive as sound.

When the normal/invert [phase] switch is engaged, the original waveform is simply reversed 180° [see Figure 2]. Again, the subwoofer cone follows the waveform. However, this time the woofer cone starts by pulling into the cabinet followed by the woofer cone pushing out. If you have ever experimented with a subwoofer polarity switch, you may not have noticed any changes to the sound regardless of its position, especially if you are listening to just the subwoofer. This is normal, as our ears perceive them both at the same time.

The normal/invert [phase] switch comes into play when the subwoofer is paired with a loudspeaker. Ideally, the woofer cones of the subwoofer and full range loudspeaker would work together by pushing and pulling in unison. SR18S subwoofers are designed to be used in a broad range of applications. The flexibility provided by the polarity switch is necessary to ensure that you are receiving the best possible sound from your system, regardless of your setup.

### Placement

SR18S subwoofers are designed to sit on the floor or stage as the main PA. They are not designed to be pole-mounted or suspended.

A socket is provided on top of the SR18S for mounting loudspeakers. The SPM400 is a great pole-mount option. See the hookup diagrams starting on page 5.



SR18S subwoofers have no rigging points and are not suitable for rigging. **NEVER** attempt to suspend an SR18S by its handles.

Check to make sure that the support surface (e.g. floor, etc.) has the necessary mechanical characteristics to support the weight of the subwoofer(s).

When pole-mounting loudspeakers, be sure that they are stabilized and secured from falling over or being accidentally pushed over. For stacked scenarios, it is highly suggested that straps are utilized. Failure to follow these precautions may result in damage to the equipment, personal injury, or death.

As with any powered components, protect them from moisture. Avoid installing an SR18S in places exposed to harsh weather conditions. If you are setting them up outdoors, make sure they are under cover if you expect rain.

### Polarity Waveforms

Figure 1: Normal [0°]

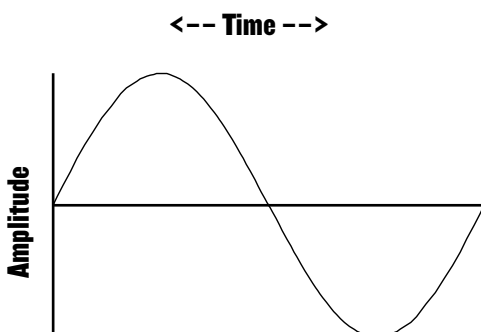
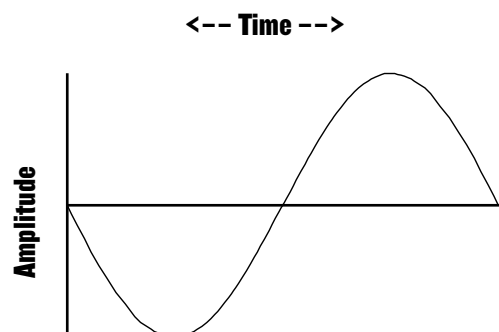

Figure 2: Invert [180°]



## Protection Circuitry

The SR18S subwoofer employs a built-in limiter for less distortion at peak levels. Additional protection includes automatic thermal shutdown should the amp overheat. However, with Class-D amp technology, which is highly-efficient, this should never be a problem.



The protection circuits are designed to protect the subwoofers under reasonable and sensible conditions. Should you choose to ignore the warning signs [e.g. excessive distortion], you can still damage the speaker in the subwoofer by overdriving it past the point of amplifier clipping. Such damage is beyond the scope of the warranty.

### Limiting

The driver has its own compression circuit which helps protect it from damaging transient peaks. The compressor is designed to be transparent and is not noticeable under normal operating conditions.

### Overexcursion Protection

A subsonic filter circuit just prior to the power amplifier prevents ultra-low frequencies from being amplified. Excessive low-frequency energy can damage the woofer by causing it to “bottom out,” also known as overexcursion, which is equivalent to a mechanical form of clipping.

### Thermal Protection

All amplifiers produce heat. The SR18S subwoofer is designed to be efficient both electrically and thermally. In the unlikely event of the amplifier overheating, a built-in thermal switch will activate, muting the signal.

When the amplifier has cooled down to a safe operating temperature, the thermal switch resets itself, and the SR18S subwoofer resumes normal operation.

If the thermal switch activates, try turning down the level control a notch or two to avoid overheating the amplifier. Be aware that direct sunlight and/or hot stage lights may be the culprit of an amplifier overheating.

## AC Power

Be sure the SR18S subwoofer is plugged into an outlet that is able to supply the correct voltage specified for your model. It will continue to operate at lower voltages, but will not reach full power. Be sure the electrical service can supply enough amperage for all the components connected to it.

We recommend that a stiff (robust) supply of AC power be used because the amplifiers place high current demands on the AC line. The more power that is available on the line, the louder the speakers will play and the more peak output power will be available for a cleaner, punchier bass. A suspected problem of “poor bass performance” is often caused by a weak AC supply to the amplifiers.



Never remove the ground pin on the power cord or any other component of the SR18S subwoofer. This is very dangerous.

## Care and Maintenance

Your SR18S subwoofer will provide many years of reliable service if you follow these guidelines:

- Avoid exposing the subwoofers to moisture. If they are set up outdoors, be sure they are under cover if rain is expected.
- Avoid exposure to extreme cold (below freezing temperatures). If you must operate the subwoofers in a cold environment, warm up the voice coils slowly by sending a low-level signal through them for about 15 minutes prior to high-power operation.
- Use a dry cloth to clean the cabinets. Only do this when the power is turned off. Avoid getting moisture into any of the openings of the cabinet, particularly where the drivers are located.



## Pairing an SRT loudspeaker with the SR18S subwoofer

If NOT using SRT Series loudspeakers, please refer to the 'Getting Started' section on page 4.

There are two recommended acoustic variations:

- One SR18S subwoofer with one SRT loudspeaker
- Two SR18S subwoofers with one SRT loudspeaker

1. Make all initial connections with the power switches OFF on all equipment. Make sure the master volume, level and gain controls are all the way down.

2. Connect the outputs from the mixing console (or other signal source) to the inputs of the SR18S.

### One SR18S subwoofer with one SRT loudspeaker

3. Connect the high pass output from the subwoofer to the input of the loudspeaker.

4. Make sure the subwoofer's and loudspeaker's gain knobs are set to "U" (unity gain).

5. Make sure the loudspeaker's input is set to "LINE" on the Configuration screen of the SRT Mix Control™. Additional information is available in the SRT Series Loudspeakers Owner's Manual.

6. Continue on with step 7.

### Two SR18S subwoofers with one SRT loudspeaker

3. Connect the full range output from the first subwoofer to the input of the next SR18S subwoofer. From here, connect the high pass output from the subwoofer to the input of the loudspeaker.

4. Make sure both subwoofers' trim knobs are set to "-6dB" (fully counter-clockwise).

5. Make sure the loudspeaker's gain knobs are set to "U" (unity gain).

6. Make sure the loudspeaker's input is set to "LINE" on the Configuration screen of the SRT Mix Control™. Additional information is available in the SRT Series Loudspeakers Owner's Manual.

7. Push the line cord securely into the subwoofer's / loudspeaker's IEC connectors and plug the other ends into grounded AC outlets. The subwoofer/ loudspeaker may accept the appropriate voltage as indicated near the IEC connector.

8. Break into your favorite dance routine.

9. Turn the mixer (or other signal source) on.

10. Turn the subwoofer(s) on.

11. Turn the loudspeaker(s) on.

12. Start the signal source and raise the mixer's main L/R fader up to a comfortably loud listening level.

### The Man, the Myth, the Legend

Evel Knievel was a force to be reckoned with! Dude attempted more than 75 death-defying motorcycle jumps throughout his illustrious career.

A little known fact is that the Mackie Running Man is a huge fan of his work and wanted to honor his legacy by jumping a whopping 16 SR18S subwoofers. What jump would you like to see the Mackie Running Man attempt next?



As much as we would love to see video of you attempting to jump a bunch of SR18S subwoofers, DON'T! Leave it to the professionals.

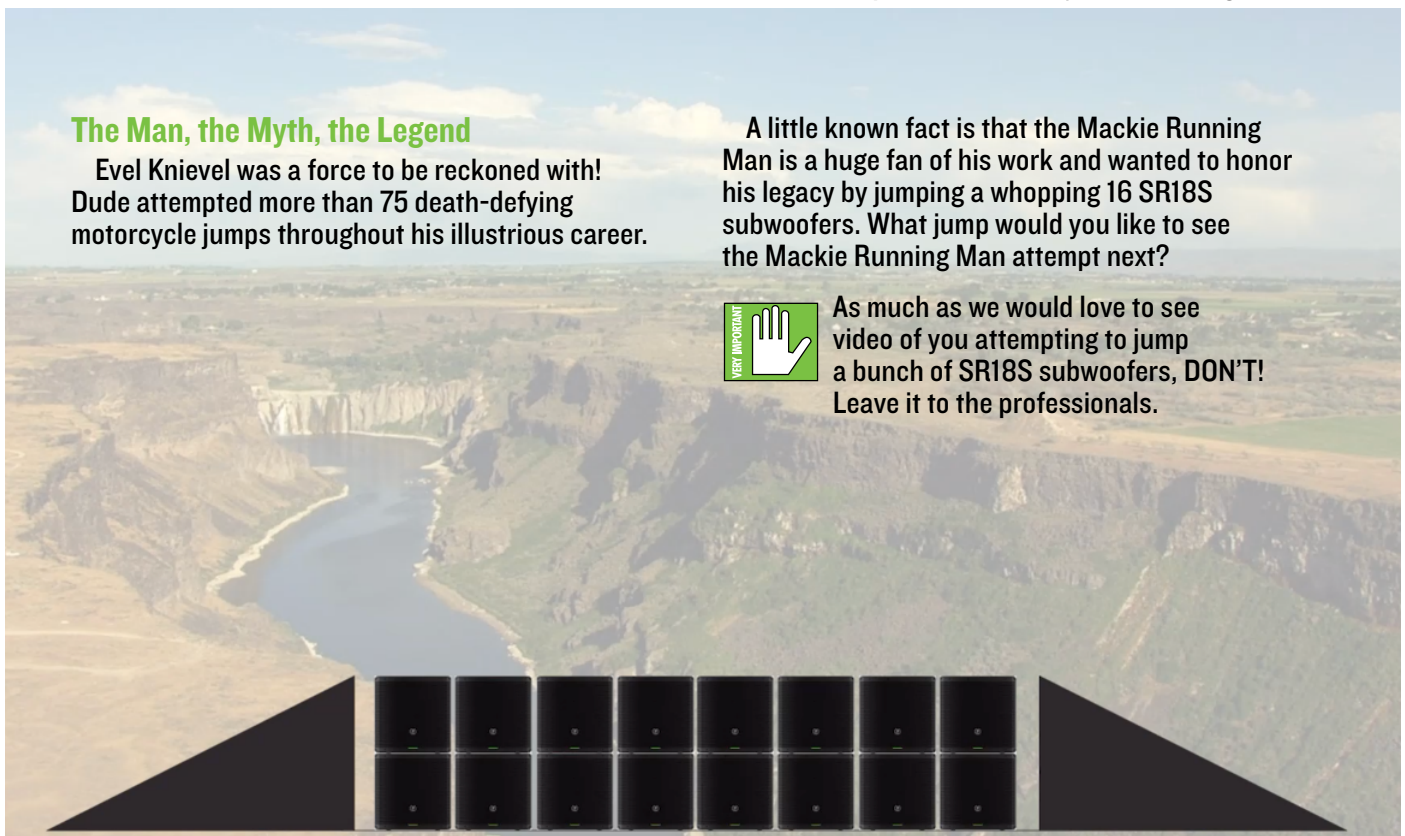

## Appendix A: Service Information

If you think your SR18S subwoofer has a problem, please check out the following troubleshooting tips and do your best to confirm the problem. Visit the Support section of our website ([www.mackie.com/support](http://www.mackie.com/support)) where you will find lots of useful information such as FAQs and other documentation. You may find the answer to the problem without having to part with your subwoofer.

### Troubleshooting

#### No power

- Our favorite question: Is it plugged in? Make sure the AC outlet is live [check with a tester or lamp].
- Our next favorite question: Is the power switch on? If not, try turning it on.
- Make sure the line cord is securely seated in the line cord socket and plugged all the way into the AC outlet.
- Is the power LED on the front panel illuminated? If not, make sure the AC outlet is live. If so, refer to "No sound" below.
- The internal AC line fuse may be blown. This is not a user serviceable part. If you suspect the AC line fuse is blown, please see the "Repair" section next.

#### No sound

- Is the level knob for the input source turned all the way down? Verify that all the volume controls in the system are properly adjusted. Look at the level meter to ensure that the mixer is receiving a signal.
- Is the signal source working? Make sure the connecting cables are in good repair and securely connected at both ends. Make sure the output level control on the mixing console is turned up sufficiently to drive the inputs of the speaker.
- Make sure the mixer does not have a mute on or a processor loop engaged. If you find something like this, make sure the level is turned down before disengaging the offending switch.
- Has it shut down? Make sure there is at least six inches of free space behind each SR18S subwoofer.

#### Poor sound

- Is it loud and distorted? Make sure that you're not overdriving a stage in the signal chain. Verify that all level controls are set properly.
- Is the input connector plugged completely into the jack? Be sure all connections are secure.

#### Poor bass performance

- Check the polarity of the connections between the mixer and the subwoofers. You may have your positive and negative connections reversed at one end of one cable, causing one subwoofer to be out-of-phase with the other.
- Poor bass performance may be the result of bad AC power. See the section titled 'AC Power' on page 12 for further details.

#### Noise

- Make sure all connections to the subwoofers and loudspeakers are good and sound.
- Make sure none of the signal cables are routed near AC cables, power transformers, or other EMI-inducing devices.
- Is there a light dimmer or other SCR-based device on the same AC circuit as the SR18S subwoofer? Use an AC line filter or plug the subwoofer into a different AC circuit.

#### Hum

- Try disconnecting the cable connected to the input jack. If the noise disappears, it could be a "ground loop," rather than a problem with the SR18S subwoofer. Try some of the following troubleshooting ideas:
  - Use balanced connections throughout your system for the best noise rejection.
  - Whenever possible, plug all the audio equipment's line cords into outlets which share a common ground. The distance between the outlets and the common ground should be as short as possible.

#### Other Issues

- Please email or call Technical Support if you are having any other issue not listed here:
  - o [mackie.com/support-contact](http://mackie.com/support-contact)
  - o 1-800-898-3211

### Repair

For warranty service, refer to the warranty information on page 18.

Non-warranty service is available at a factory-authorized service center. To locate the nearest service center, visit [www.mackie.com/support/service-locator](http://www.mackie.com/support/service-locator). Service for SR18S subwoofers living outside the United States may be obtained through local dealers or distributors.

If you do not have access to our website, please call our Tech Support department at 1-800-898-3211 (normal business hours, Pacific Time), to explain the problem. They will tell you where the nearest factory-authorized service center is located in your area.

# Appendix B: Technical Information

## SR18S Subwoofer Specifications

### Acoustic Performance

Frequency Range (-10 dB):	33 Hz – 200 Hz (Deep HPM) 35 Hz – 200 Hz (Flat HPM) 38 Hz – 200 Hz (Punch HPM)
Frequency Range (-3 dB):	35 Hz – 160 Hz (Deep HPM) 41 Hz – 160 Hz (Flat HPM) 46 Hz – 160 Hz (Punch HPM)
Maximum SPL Peak:	133 dB

### Transducers

Low Frequency:	18 in / 457 mm woofer with ferrite
----------------	------------------------------------

### Power Amplifiers

System Power Amplification	
Rated Power	1600 watts peak
Low Frequency Power Amplifier	
Rated Power:	1600 watts peak
Rated THD	< 1%
Cooling	Convection
Design:	Class D

### System Processing

Phase	Normal / Invert
High Pass Mode	SR Flat, SR Deep, SR Punch, Variable

### Input/Output

Input Type:	2x Female XLR Balanced Differential (Stereo Left / Right)
Input Impedance:	20 kΩ Balanced, 10 kΩ Unbalanced
Full Range Outputs:	2x Male XLR Balanced (Parallel with Inputs – Mono)
Full Range Impedance:	300 Ω Balanced
High Pass Outputs:	2x Male XLR Balanced
High Pass Impedance:	300 Ω Balanced
Main Level Control:	Rotating Knob

### Line Input Power

Detachable line cord	~100 – 240 VAC, 50 – 60 Hz, 110W
AC Connector	3-pin IEC 250 VAC, 10 A male
Power Supply Type	Switchmode

### Safety Features

Input Protection	Peak and RMS limiting, power supply and amplifier thermal protection
Display LEDs	Defeatable front power

### Construction Features

Basic Design:	Rectangular
Enclosure Material:	15mm poplar plywood
Enclosure Finish:	Black Polyurethane
Grille Material:	11 gauge ASTM A36 Steel
Grille Finish:	Powder-coated black
Handles:	One on each side
Display LEDs	
Front:	Power ON
Rear:	High Pass Mode, Sig / Clip
Operating Temperature:	0 – 40 °C 32 – 104 °F

### Physical Properties

Height:	23.3 in / 592 mm
Width:	23.0 in / 584 mm
Depth:	27.0 in / 686 mm
Weight:	74.5 lb / 33.8 kg

### Mounting Methods:

SR18S subwoofers are designed to sit on the floor or stage. They are NOT designed to be pole-mounted or suspended. The cabinet has no rigging points and is not suitable for rigging. Never attempt to suspend an SR18S subwoofer by its handles.

### Options

SR18S Cover	P/N 2036809-60
SPM400 Loudspeaker Pole Mount	P/N 2051055

### Disclaimer

Since we are always striving to make our products better by incorporating new and improved materials, components, and manufacturing methods, we reserve the right to change these specifications at any time without notice.

The "Running Man" figure is a registered trademark of LOUD Audio, LLC.

All other brand names mentioned are trademarks or registered trademarks of their respective holders, and are hereby acknowledged.

©2020 LOUD Audio, LLC. All Rights Reserved.



## SR18S Subwoofer Magnitude Response Legend and Graph

**FLAT High Pass Mode** – This factory default setting delivers nice, balanced bass, suitable for all music types.

**DEEP High Pass Mode** – SR Deep trades a bit of output for much deeper bass extension. This mode pairs well with electronic music, or for use with electronic keyboards.

**PUNCH High Mode** – SR Punch has opposite shaping of SR Deep. It delivers a higher peak SPL at the expense of LF extension, while still maintaining musicality. Optimized for use with live music.

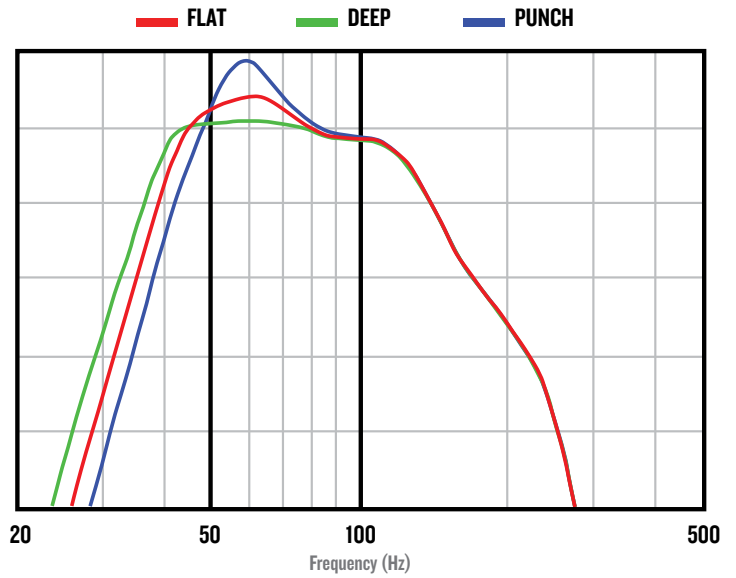

The Magnitude Response graph was generated using a Klippel NFS.

## SR18S Subwoofer Dimensions

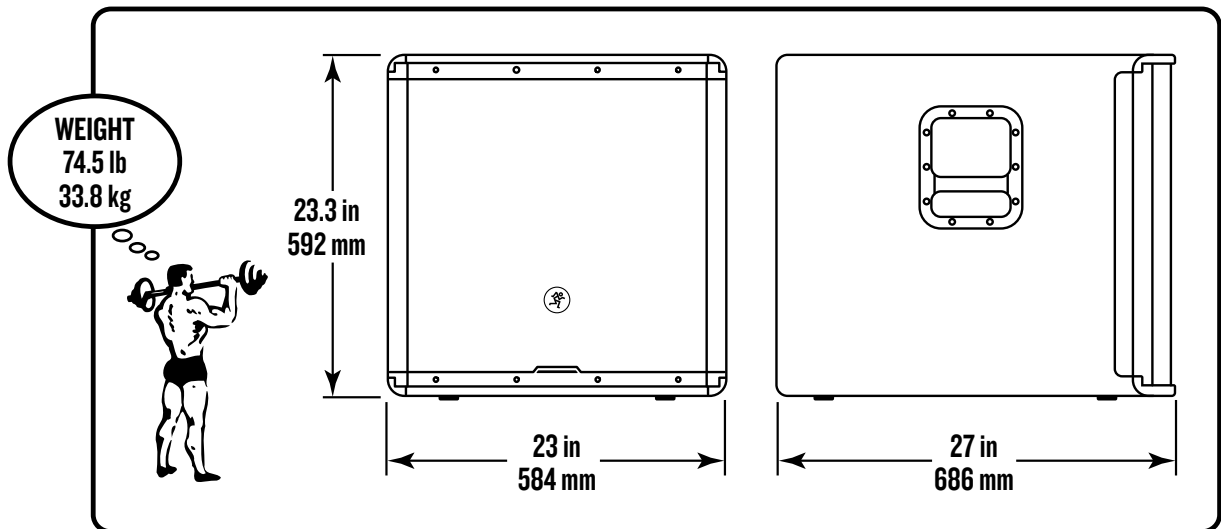

# SR18S Subwoofer Block Diagram

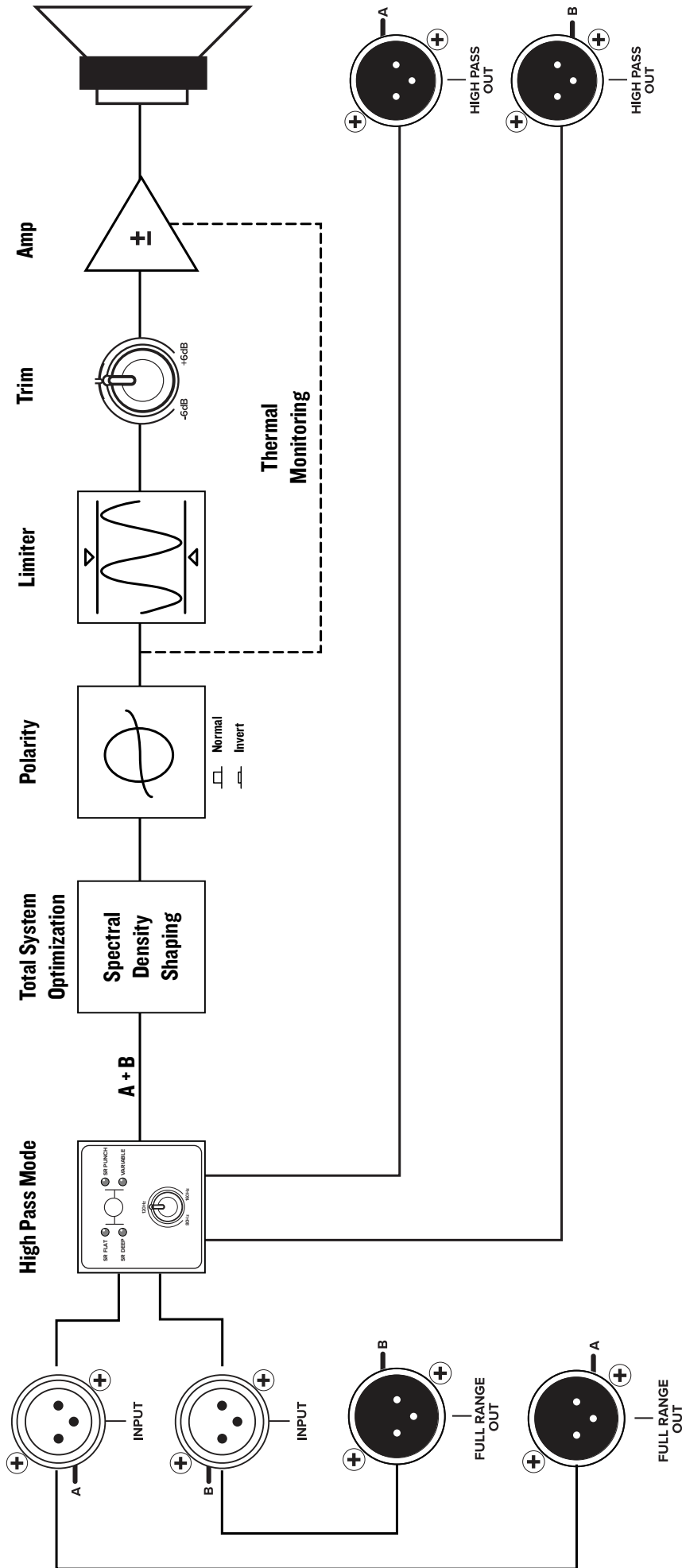

## Limited Warranty

### **Please keep your sales receipt in a safe place.**

This Limited Product Warranty ("Product Warranty") is provided by LOUD Audio, LLC ("LOUD") and is applicable to products purchased in the United States or Canada through a LOUD-authorized reseller or dealer. The Product Warranty will not extend to anyone other than the original purchaser of the product (hereinafter, "Customer," "you" or "your").

For products purchased outside the U.S. or Canada, please visit [www.mackie.com](http://www.mackie.com) to find contact information for your local distributor, and information on any warranty coverage provided by the distributor in your local market.

LOUD warrants to Customer that the product will be free from defects in materials and workmanship under normal use during the Warranty Period. If the product fails to conform to the warranty then LOUD or its authorized service representative will at its option, either repair or replace any such nonconforming product, provided that Customer gives notice of the noncompliance within the Warranty Period to the Company at: [www.mackie.com](http://www.mackie.com) or by calling LOUD technical support at 1.800.898.3211 (toll-free in the U.S. and Canada) during normal business hours Pacific Time, excluding weekends or LOUD holidays. Please retain the original dated sales receipt as evidence of the date of purchase. You will need it to obtain any warranty service.

For full terms and conditions, as well as the specific duration of the Warranty for this product, please visit [www.mackie.com](http://www.mackie.com).

The Product Warranty, together with your invoice or receipt, and the terms and conditions located at [www.mackie.com](http://www.mackie.com) constitutes the entire agreement, and supersedes any and all prior agreements between LOUD and Customer related to the subject matter hereof. No amendment, modification or waiver of any of the provisions of this Product Warranty will be valid unless set forth in a written instrument signed by the party to be bound thereby.

### **Need help with the SR18S subwoofer?**

- Visit [www.mackie.com/support](http://www.mackie.com/support) to find: FAQs, manuals, addendums, and other documents.
- Email us at: [www.mackie.com/support-contact](http://www.mackie.com/support-contact)
- Telephone 1-800-898-3211 to speak with one of our splendid technical support chaps (Monday through Friday, normal business hours, Pacific Time).



---

**19820 North Creek Parkway #201**

**Bothell, WA 98011 • USA**

**Phone: 425.487.4333**

**Toll-free: 800.898.3211**

**Fax: 425.487.4337**

**[www.mackie.com](http://www.mackie.com)**

---