

ERA 600 Performance

ERA 600 Profile

Safety and Installation Manual



Dimensions

All measurements are given in millimeters

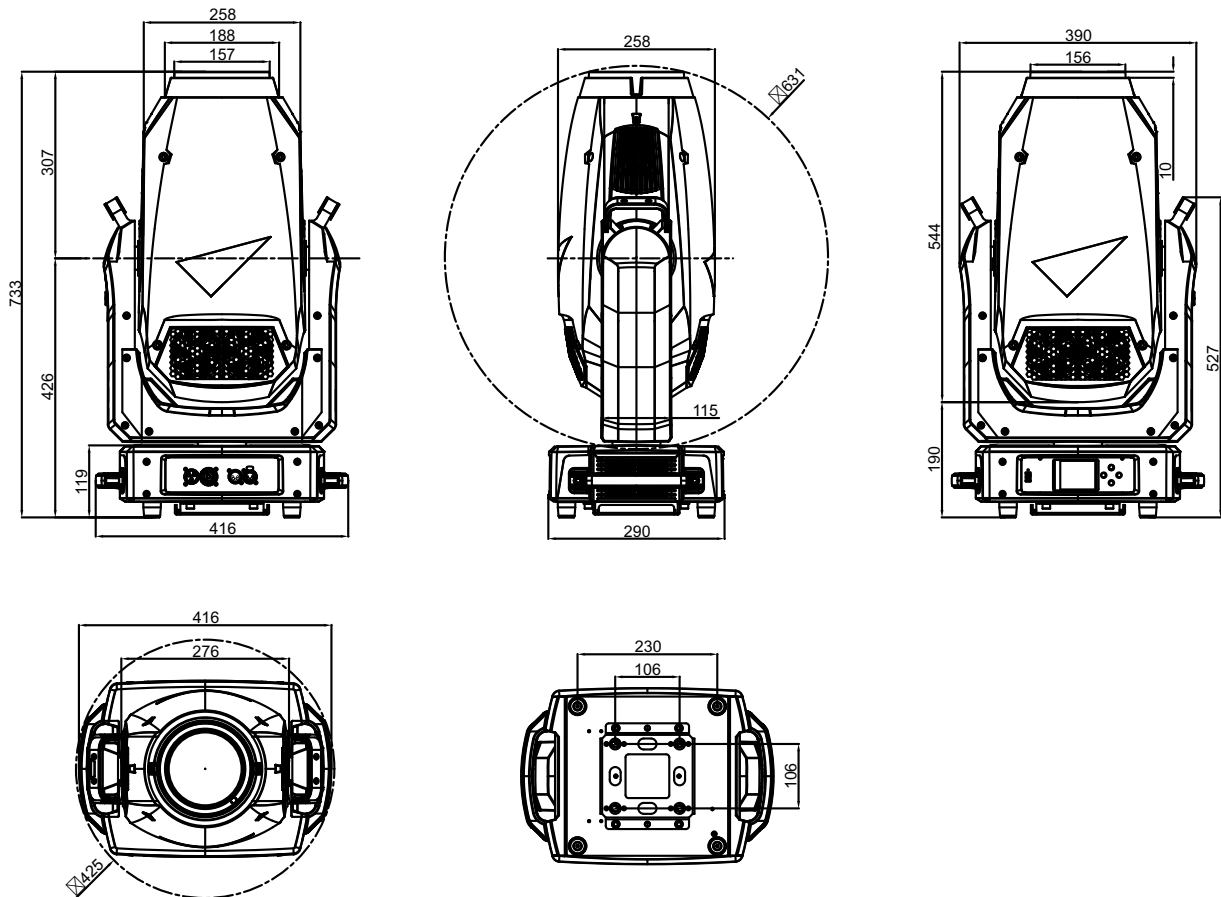

©2018-2020 HARMAN PROFESSIONAL DENMARK ApS. All rights reserved. Features, specifications and appearance are subject to change without notice. HARMAN PROFESSIONAL DENMARK ApS and all affiliated companies disclaim liability for any injury, damage, direct or indirect loss, consequential or economic loss or any other loss occasioned by the use of, inability to use or reliance on the information contained in this document. Martin is a registered trademark of HARMAN PROFESSIONAL DENMARK ApS registered in the United States and/or other countries.

HARMAN PROFESSIONAL DENMARK ApS, Olof Palmes Allé 44, 8200 Aarhus N, Denmark
HARMAN PROFESSIONAL SOLUTIONS U.S., 8500 Balboa Blvd., Northridge CA 91329, USA

www.martin.com

Contents

Safety Information	4
Introduction	8
Unpacking	8
Packing	9
Physical installation	10
AC power.	13
Power input	13
Data links.	15
DMX and RDM.	15
Service and maintenance	16
Tilt lock.	16
Cleaning.	17
Lubrication	17
Service utilities.	17
Calibration	18
Installing firmware	19
Rotating gobo replacement	20
Converting between Performance and Profile	29
Using the fixture	33
Applying power	33
ERA 600 Profile battery power	33
Troubleshooting	34
Specifications	35

Safety Information



WARNING!

Read the safety precautions in this section before installing, powering, operating or servicing this product.

The following symbols are used to identify important safety information on the product and in this document:



DANGER!
Safety hazard.
Risk of severe injury or death.



DANGER!
Hazardous voltage. Risk of lethal or severe electric shock.



WARNING!
Fire hazard.



WARNING!
Burn hazard. Hot surface. Do not touch.



WARNING!
Intense light emission.



WARNING! Refer to user documentation.



Warning! *The ERA 600 Performance / Profile from Martin® contains components that are accessible and live at high voltage while the fixture is connected to power. These components remain under tension for up to one minute after power is disconnected.*



Warning! *Risk Group 3 product (see “Protection from eye injury” on page 6 for full details). This product produces intense light output that may be hazardous if suitable precautions are not taken. Do not view the light output with optical instruments or any device that may concentrate the beam.*

This product presents risks of severe injury or death due to fire and burn hazards, electric shock and falls if the safety precautions in this manual are not followed.



Read this manual before installing, powering or servicing the fixture. Follow the safety precautions and observe all warnings in this manual, in the ERA 600 Performance / Profile User Guide and printed on the fixture.

The latest versions of this Safety and Installation Manual and the ERA 600 Performance / Profile User Guide are available for download from the ERA 600 Performance / Profile areas of the Martin website at www.martin.com. Before you install, operate or service the fixture, check the Martin website and make sure that you have the latest user documentation for the fixture. Document revisions are indicated at the bottom of page 2.

This product is for professional use only. It is not for household use. Respect all locally applicable laws, codes and regulations when installing, powering, operating or servicing the fixture.

Install, operate and service Martin products and accessories only as directed in their user documentation, or you may create a safety hazard or cause damage that is not covered by product warranties.

The latest software, manuals and other documentation for all Martin products are available for download at www.martin.com

Technical Support

If you have questions about how to install or operate the fixture safely, please contact Harman Professional Technical support:

- For technical support in North America, please contact: HProTechSupportUSA@harman.com
Phone: (844) 776-4899
- For technical support outside North America, please contact your national distributor.



PROTECTION FROM ELECTRIC SHOCK

- Do not expose the fixture to rain or moisture.
- Do not remove any cover from the fixture except as described under “Service and maintenance” on page 16.
- Disconnect the fixture from AC mains power before servicing it and when it is not in use.
- Ensure that the fixture is electrically connected to ground (earth).
- Use only a source of AC mains power that complies with local building and electrical codes and has both overload and ground-fault (earth-fault) protection.
- The fixture accepts AC mains power at 100-240 VAC (nominal), 50/60 Hz. Do not connect the fixture to mains power that is not within this range.
- The voltage and frequency at the power throughput socket are the same as that applied at the power input socket.
- Do not connect devices to power in a chain or circuit that will exceed the electrical ratings of any cable or connector used in the circuit.
- The fixture’s MAINS IN connector supplies mains power both to the fixture itself and to the MAINS OUT/THRU socket. The MAINS IN connector has a maximum current rating of 16 A, so you must make sure that the total current draw of any devices that are connected to the MAINS OUT/THRU socket plus the current draw of the fixture itself does not exceed 16 A total. Respect the following safety limits:
 - Do not connect more than one ERA 600 Performance / Profile fixture to the MAINS OUT/THRU socket when operating on mains power within the range 100-200 V.
 - Do not connect more than three ERA 600 Performance / Profile fixtures to the MAINS OUT/THRU socket when operating on mains power within the range 200-240 V.
- Power input and throughput cables must be rated 20 A minimum, 12 AWG or 2.5 mm² minimum conductor size and heat-resistant to 90° C (194° F) minimum. Cables must have three conductors and an outer cable diameter of 6 - 12 mm (0.24 - 0.47 in.). In North America the cable must be UL/CSA-recognized, hard usage, type SJT, SJOOW or better. In the EU, the cable must be type HO5VV-F, H07RN-F or better.
- Connect only a Neutrik powerCON TRUE1 NAC3FX-W (TOP) type cable connector to the power input socket. Connect only a Neutrik powerCON TRUE1 NAC3MX-W (TOP) type cable connector to the power throughput socket.
- Before using the fixture, check that all power distribution equipment, connectors and cables are in perfect condition and rated for the current requirements of all connected devices.
- Isolate the fixture from power immediately if the power plug or any seal, cover, cable, or other component is damaged, defective, deformed, wet or showing signs of overheating. Do not reapply power until repairs have been completed.
- The fixture contains components that are accessible and live at high voltage while the fixture is connected to power and that remain under tension for up to one minute after power is disconnected. Wait for at least one minute after disconnecting from power before opening any of the fixture’s covers.
- Refer any service operation not described in this manual or in the ERA 600 Performance / Profile User Guide to Martin Service or an authorized Martin Service partner.
- The light source contained in this fixture shall be replaced by Martin Service or an authorized Martin Service partner only.



PROTECTION FROM BURNS AND FIRE

- The exterior of the fixture becomes hot during use. After 5 minutes of operation a surface temperature of 70° C (158° F) shall be expected. The maximum steady state surface temperature is also 75° C (167° F). Avoid contact by persons and materials.
- Allow the fixture to cool for at least 30 minutes before handling.
- Keep all combustible materials (e.g. fabric, wood, paper) at least 0.2 m (8 in.) away from the fixture.
- Keep flammable materials well away from the fixture.
- Ensure that there is free and unobstructed airflow around the fixture.
- Provide a minimum clearance of 0.2 m (8 in.) around fans and air vents.
- Do not illuminate surfaces within 2.0 m (6.6 ft.) of the fixture.
- Do not expose the front glass to sunlight or any other strong light source from any angle. Lenses can focus the sun's rays inside the fixture, creating a potential fire hazard.
- Do not attempt to bypass thermostatic switches or fuses.
- Do not operate the fixture if the ambient temperature (Ta) exceeds 40° C (104° F).



- Do not modify the fixture in any way not described in this manual or the fixture's User Guide or install other than genuine Martin parts. Do not stick filters, masks or other materials onto any lens or other optical component. Use only accessories approved by Martin to mask or modify the light beam.

PROTECTION FROM EYE INJURY



- This fixture corresponds to Risk Group 3 according to EN 62471 when all photobiological risks are considered and Risk Group 2 product according to IEC/TR 62778 for blue light only. It emits possibly hazardous optical radiation. It falls into the Risk Group categories shown below according to both EN 62471 and IEC/TR 62778 under worst-case conditions:

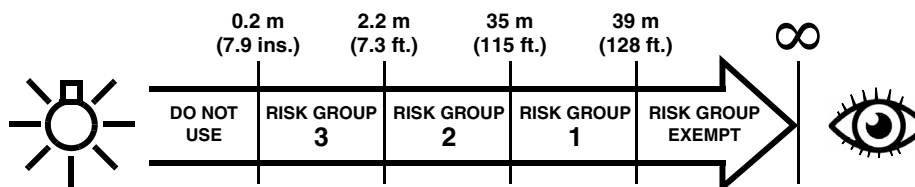

- At a distance of less than 2.2 m (7.3 ft.) from the fixture, the light output can potentially cause eye or skin injury before an exposed person's natural aversion responses (blink reflex and reaction to skin discomfort) can protect them. At distances greater than 2.2 m (7.3 ft.), potential eye and skin injury hazards from the light output are normally prevented by natural aversion reflexes.
- Position the fixture so that persons cannot be exposed to the fixture's light output at a distance of less than 2.2 m (7.3 ft.) from the fixture, and so that prolonged staring into the light output at less than 35 m (115 ft.) from the fixture is not expected.
- Do not look directly into the fixture's light output.
- Do not look at LEDs with magnifiers, telescopes, binoculars or similar optical instruments that may concentrate the light output.
- Ensure that persons are not looking at the fixture when the fixture lights up suddenly. This can happen when power is applied, when the fixture receives a DMX signal, or when certain control menu items are selected.
- Disconnect the fixture from power at all times when the fixture is not in use.
- Provide well-lit conditions to reduce the pupil diameter of anyone working on or near the fixture.

PROTECTION FROM INJURY



- Fasten the fixture securely to a fixed surface or structure when in use. The fixture is not portable when installed.
- Do not lift or carry the fixture alone.
- Use two evenly spaced omega brackets with clamps to suspend the fixture from rigging structures. Do not use only one clamp.
- When clamping the fixture to a truss or other supporting structure, use two half-coupler clamps. Do not use G-clamps, quick-trigger clamps or any other type of clamp that does not completely encircle the supporting structure when fastened.
- When suspending the fixture, check that the supporting structure and all hardware used to suspend the fixture can hold at least six (6) times the weight of all devices suspended from them and that the installation respects all similar safety factors that are required by locally applicable regulations. Check that the structure and hardware are in perfect condition and suitable for their purpose.
- If the fixture is installed in a location where it may cause injury or damage if it falls, install as described in this manual a secondary attachment such as a safety cable that is approved by an official body such as TÜV as a safety attachment for the weight that it secures. The safety cable must comply with EN/IEC 60598-2-17:2018 Section 17.7.4 or BGV C1 / DGUV 17, and must be capable of bearing a static suspended load at least six times (or more if required by locally applicable regulations) the weight that it secures.
- Eliminate as much slack as possible in the safety cable (by looping it more than once around the rigging truss, for example). Make sure that, if the primary attachment fails, the fixture cannot fall more than 20 cm (8 inches) maximum before the safety cable catches it.
- If the safety cable attachment point becomes deformed, do not suspend the fixture. Have the fixture repaired by an authorized Martin service partner.
- Check that all external covers and rigging hardware are securely fastened.

- Block access below the work area and work from a stable platform whenever installing, servicing or moving the fixture.
- Allow enough clearance around the head to ensure that it cannot collide with a person or object such as another fixture when it moves.

Introduction

Thank you for selecting an ERA 600 Performance or ERA 600 Profile lighting fixture from Martin®. These moving-head spotlights share the features listed below apart from one effect – the ERA 600 Performance has a four-blade rotating framing module while the ERA 600 Profile has an additional rotating gobo wheel with seven rotating gobos.

ERA 600 Performance and Profile

- Bright 550 W, 6500 K LED light source
- 19 000 lumens output
- Crisp optics with flat field
- 1:8 fast zoom
- CMY color mixing
- Linear CTO – daylight to tungsten CCT control and expansion of the CMY palette
- 7-slot color wheel for added color choice and split color effects
- Rotating gobo wheel with 7 rotating gobos
- Gobo wheel with 8 static gobos for great morphing effects
- Animation wheel with continuous bi-directional rotation
- Fast, tight iris
- Two prisms – 4-facet and linear – with rotation and indexing control
- Heavy frost for smooth wash effects
- Compact, low weight design

ERA 600 Performance

- Full curtain framing blades with +/- 60° rotation of entire system for flexible shape generation

ERA 600 Profile

- Additional rotating gobo wheel (Gobo Wheel 3) with 7 rotating gobos
- Battery power for control panel and display (mains power not required for fixture setup)

Conversion between Performance and Profile fixture types

It is possible to order the parts from Martin that let you convert fixtures from ERA 600 Performance to ERA 600 Profile configuration (Gobo Wheel 3 module) and from ERA 600 Profile to ERA 600 Performance configuration (framing module). See “Accessories” on page 37.

From firmware version 2.2.0, the same firmware is installed in Performance and Profile fixtures. The firmware automatically detects the fixture type that it is installed in and gives the correct functionality for that fixture type.

Information and user manuals

For the latest user documentation and other information about this and all Martin products, please visit the Martin website at www.martin.com

Unpacking

The ERA 600 Performance / Profile is packed in a cardboard box that is designed to protect the fixture during initial shipment only. We strongly recommend that you store and transport fixtures in the flightcases available from Martin (or custom flightcases of the same quality).

This Safety and Installation Manual is included with the fixture. The ERA 600 Performance / Profile User Guide, containing full details of setting up, controlling and monitoring the fixture, is available for download from the ERA 600 Performance and ERA 600 Profile areas of the Martin website at www.martin.com. If you have any difficulty locating this document, please contact your Martin supplier for assistance.

Tilt lock

Check that the tilt lock is released before applying power to the fixture.

See Figure 1. Release the tilt lock by sliding the tilt lock button (arrowed) to the **Unlocked** position.

You can reapply the tilt lock by first checking that the power is off and then sliding the tilt lock button back to the **Locked** position.

Release the tilt lock before putting the fixture into its flightcase for transport or storage.

Packing

Important! *Allow the fixture to cool for 30 minutes and release the tilt lock before packing it in its flightcase.*

A rugged two-unit flightcase is available from Martin for the ERA 600 Performance / Profile.

The flightcase is designed to support the head with the tilt lock (see Figure 1) in the Unlocked position. Release the tilt lock before putting a fixture into a flightcase for transport. Leaving the tilt lock applied may cause damage that is not covered by the product warranty.

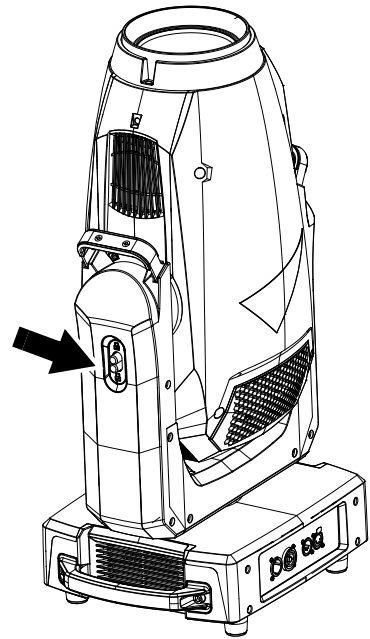

Figure 1: Tilt lock

Physical installation



Warning! The ERA 600 Performance / Profile has a powerful pan motor. The torque reaction when the head is panned suddenly can cause the base to move if the fixture is standing unsecured on a surface. Do not apply power to the ERA 600 Performance / Profile unless the base is securely fastened to a stable surface or structure.

Warning! Use two clamps to rig the fixture. Do not hang the fixture from only one clamp. Lock each clamp with both 1/4-turn fasteners. Fasteners are locked only when turned a full 90° clockwise.

Warning! When suspending the fixture above ground level, secure it against failure of primary attachments by attaching a safety cable that is approved as a safety attachment for the weight of the fixture to the attachment point in the base. Do not use the carrying handles for secondary attachment.

Warning! When clamping the fixture to a truss or other structure at any other angle than with the yoke hanging vertically downwards, use two clamps of half-coupler type. Do not use any type of clamp that does not completely encircle the structure when fastened.

Warning! You can fasten the fixture to a surface with ratchet straps passed through the carrying handles so that the fixture cannot fall over, but do not over-tighten the ratchet straps or you may damage the carrying handles and leave the fixture in an unsafe condition.



Warning! Position or shade the head so that the front lens will not be exposed to sunlight or another strong light source from any angle – even for a few seconds. See Figure 2. The ERA 600 Performance / Profile's lens can focus the sun's rays, creating a potential fire hazard and causing damage.

Important! Do not point the output from other lighting fixtures at the ERA 600 Performance / Profile, as powerful light can damage the display.

See Figure 2. Lenses can focus sunlight and strong light, presenting a risk of fire and damage to the fixture. Shield or shade the head if necessary.

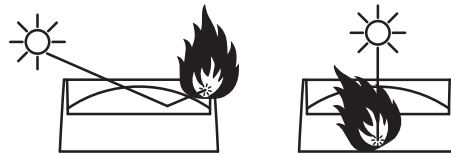

Figure 2: Potential sunlight damage

The ERA 600 Performance / Profile can be fastened to a surface such as a stage or clamped to a truss in any orientation.

Clamps must be half-coupler type (see Figure 4) or equivalent type that fully encircles the truss unless the fixture is installed with the yoke hanging vertically downwards, in which case other clamp types that are approved for the supported weight may be used.

The mounting points in the base allow omega brackets and rigging clamps to be fastened as shown in Figure 3.

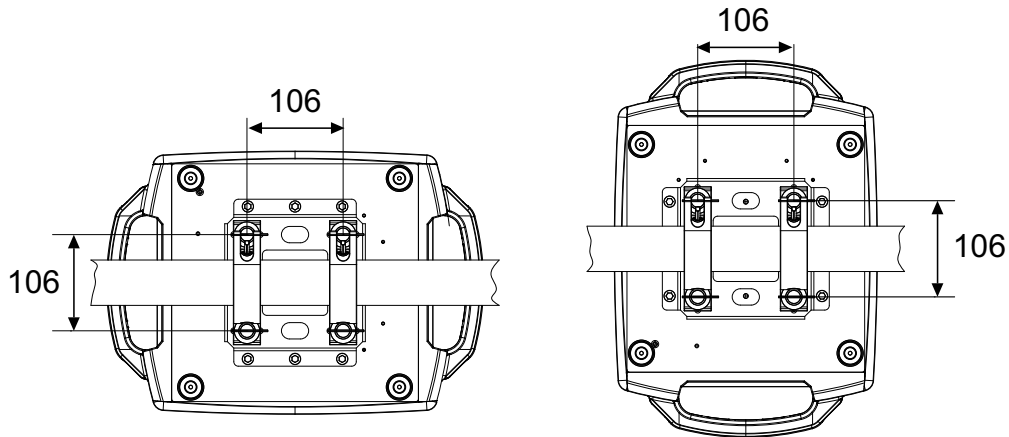
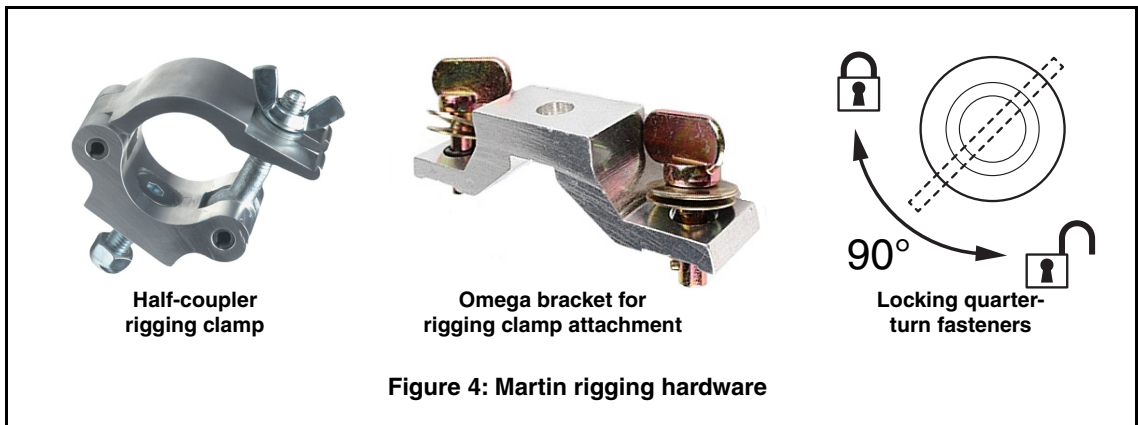

Figure 3: Clamp bracket positions

Clamping the fixture to a truss

1. Check that all rigging hardware is undamaged and can bear at least six (6) times the weight of the fixture or as required by locally applicable regulations. Check that the supporting structure can safely bear the weight of all installed fixtures, clamps, cables, auxiliary equipment, etc. and complies with locally applicable regulations.
2. Bolt each rigging clamp securely to an omega bracket with an M12 bolt (minimum grade 8.8) and self-locking nut.



3. See Figure 3 on page 11. Align the first clamp and bracket with 2 mounting points in the base, and engage both the clamp bracket's quarter-turn fasteners in corresponding sockets in the base. See Figure 4. Turn the levers on the quarter-turn fasteners a full 90° clockwise to lock. Repeat for the second clamp.
4. Block access under the work area. See Figure 5. Note the position of the arrow marked **FRONT** on the base of the fixture. Working from a stable platform, hang the fixture on the truss with the arrow marked **FRONT** facing towards the area to be illuminated. Tighten the rigging clamps.

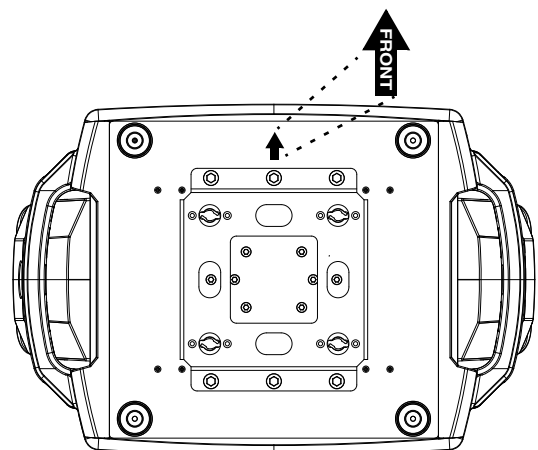

Figure 5: Front of fixture

5. See Figure 6. Install a safety cable that is approved as a safety attachment for the weight of the fixture by looping it through one of the four safety cable attachment points (arrowed) in the bottom of the base and around a secure anchoring point so that the safety cable will catch the fixture if a primary attachment fails. Remove as much slack as possible from the safety cable (by looping it more than once around the truss bar, for example).
6. Check that the tilt lock is released. Check that there are no combustible materials within 0.2 m (8 in.) or surfaces to be illuminated within 2.0 m (6.6 ft.) of the fixture, and that there are no flammable materials nearby.
7. Check that there is no possibility of the head colliding with objects or other fixtures.
8. Check that other lighting fixtures cannot project light at the ERA 600 Performance / Profile, as powerful illumination can damage the fixture's display.

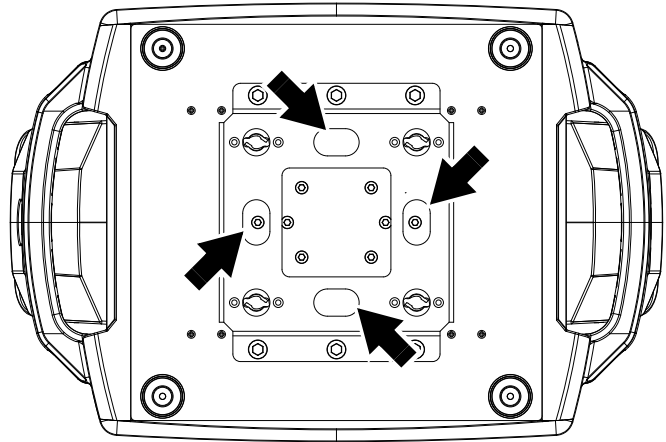

Figure 6: Safety cable attachment points

AC power



Warning! Read “Safety Information” on page 4 before connecting the fixture to AC mains power. Note in particular that you must not connect more than one ERA 600 Performance / Profile fixture to the MAINS OUT/THRU socket when operating on 100-200 V mains power, and you must not connect more than three ERA 600 Performance / Profile fixtures to the MAINS OUT/THRU socket when operating on 200-240 V mains power.



For protection from electric shock, the fixture must be electrically connected to ground (earth). The AC mains power distribution circuit must be equipped with a fuse or circuit breaker and ground-fault (earth-fault) protection.



Power input

Important! Connect the ERA 600 Performance / Profile directly to AC power. Do not connect it to a dimmer system; doing so may damage the fixture.

The ERA 600 Performance / Profile features an auto-sensing switch-mode power supply that automatically adapts to AC mains power at 100-240 VAC (nominal), 50/60 Hz. Do not connect the fixture to power that is not within this range.

The ERA 600 Performance / Profile requires a power input cable with a Neutrik powerCON TRUE1 NAC3FX-W (TOP) female cable connector for AC mains power input. The cable must meet the requirements listed under “Protection from electric shock” on page 5. Martin can supply suitable cables with female TRUE1 input connectors 1.5 m (4.9 ft.) or 5 m (16.4 ft.) long. Alternatively, Martin can supply loose female TRUE1 input connectors (see “Accessories” on page 34).

Connection to an AC mains power source

The power cable can be hard-wired to a building installation circuit or fitted with a mains plug (cord cap) to allow connection to local AC mains power outlets.

If you install a mains plug on the power cable, install a grounding-type (earthed) plug rated minimum 16 A, 250 V (example rating: EN 60309-2 CEE 2P+E 16 A/250 VAC), following the plug manufacturer’s instructions. Table 1 shows some possible mains power pin identification schemes; if the pins are not clearly identified, or if you have any doubts about proper installation, consult a qualified electrician.



Wire Color (US)	Wire Color (EU)	Pin	Symbol	Screw (US)
black	brown	live	L	yellow or brass
white	blue	neutral	N	silver
green	yellow/green	ground (earth)	 or 	green

Table 1: Cord cap (mains plug) connections

If you need to install a Neutrik powerCON TRUE1 connector on a power cable, follow the instructions on the Neutrik website at www.neutrik.com.

Linking more than one fixture to power in a chain

If you obtain a 12 AWG / 2.5 mm² power input cable and 12 AWG / 2.5 mm² power relay cables from Martin (see “Accessories” on page 37), you can relay mains power from one fixture to another by connecting fixtures to power in a linked daisy-chain, MAINS OUT throughput socket to MAINS IN input socket. If you create a linked daisy-chain like this, you must respect the following safety limits, or you may create a risk of fire and electric shock.

Using 12 AWG / 2.5 mm² cables from Martin, you can link:

- maximum two (2) ERA 600 Performance / Profile fixtures total in one chain at 100-200 V, or
- maximum four (4) ERA 600 Performance / Profile fixtures total in one chain at 200-240 V.

If you connect more than one fixture to power in a daisy-chain, we recommend that you draw power from a circuit that is protected by a type D MCB (Miniature Circuit Breaker). This will avoid the breaker tripping unnecessarily because of inrush current. If the only available power circuits have type C MCBs, you may need to connect maximum two (2) fixtures per daisy-chain at 200-240 V in order to avoid tripping breakers unnecessarily.

Connecting to power



Warning! The ERA 600 Performance / Profile does not have a power On/Off switch. As soon as you connect an energized power input cable to the fixture or apply power to a power input cable that has already been connected, the fixture will power up: check that there is no safety risk from head movement or intense light output.

To apply power to the ERA 600 Performance / Profile:

1. Check that the tilt lock is released and that the base is held securely. Be prepared for the fixture to light up and the head to move suddenly when power is applied.
2. See Figure 7. line up the keys in the power input cable's TRUE1 connector with the keyways in the MAINS IN socket (arrowed). Insert the connector into the socket and twist clockwise to engage. If the connector seems difficult to twist, remove it from the socket, check that you have lined up the keyways correctly and try again – do not use excessive force. Make sure that the connector latch clicks and that the connector is locked into the socket.
3. Apply power to the power input cable to power the fixture on.

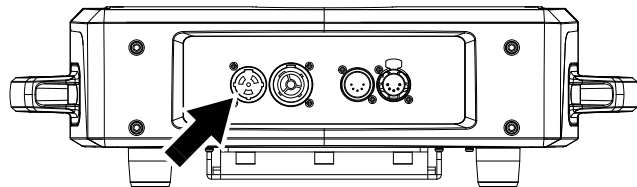

Figure 7: Mains input socket

To disconnect the ERA 600 Performance / Profile from power, pull the release latch on the connector towards you to unlock the connector, twist the connector counter-clockwise, and then withdraw it from the MAINS IN socket.

Data links

Important! Shut down power to the fixture before connecting to or disconnecting from data.

DMX and RDM

The ERA 600 Performance / Profile has 5-pin locking XLR sockets for DMX and RDM input and output (see **A** in Figure 8). The default pin-out on both sockets is:

- pin 1 to shield
- pin 2 to data 1 cold (-)
- pin 3 to data 1 hot (+).

Pins 4 and 5 are not used by the fixture but are bridged between input and output sockets. These pins can therefore be used as a pass-through connection for an additional data signal if required.

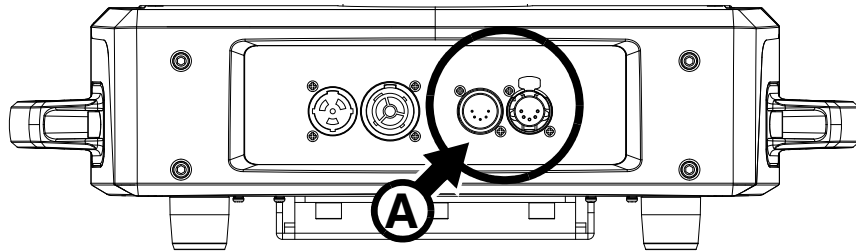

Figure 8: Data connections

Tips for reliable data transmission

- Use shielded twisted-pair cable designed for RS-485 devices: standard microphone cable cannot transmit control data reliably over long runs. 24 AWG cable is suitable for runs up to 300 meters (1000 ft). Heavier gauge cable and/or an amplifier is recommended for longer runs.
- To split the data link into branches, use a *Martin RDM 5.5 Splitter* optically isolated splitter-amplifier (see “Related Items” on page 37).
- Do not overload the DMX data link. You can connect up to a maximum of 32 devices on a serial DMX link.
- Install a DMX termination plug on the last fixture on the link.

Connecting to data via DMX cable

To connect the ERA 600 Performance / Profile to DMX and/or RDM data carried over DMX cable:

1. Shut down power to the fixture.
2. Connect the DMX data output from the controller to the ERA 600 Performance / Profile’s data input (male XLR) socket using good-quality DMX cable.
3. Run DMX cable from the ERA 600 Performance / Profile’s data output (female XLR) socket to the data input of the next fixture and continue until the link is complete.
4. Terminate the data link by connecting a 120 Ohm, 0.25 Watt resistor between the data 1 hot (+) and cold (-) conductors at the data output of the last fixture on the link. If the link is divided into branches using a DMX splitter, terminate each branch of the link.
5. You can now apply power.

Service and maintenance



Warning! Read “Safety Information” on page 4 before servicing the ERA 600 Performance / Profile.

Warning! Disconnect the fixture from AC mains power and allow to cool for at least 30 minutes before handling. Do not stare into the light output. Be prepared for the fixture to light and move suddenly when connected to power.



Warning! The ERA 600 Performance / Profile contains components that are accessible and live at high voltage while the fixture is connected to power and that remain under tension for one minute after power is disconnected. Only qualified technicians are permitted to open the fixture. Users may carry out external cleaning and replace gobos as described in this section, following the warnings and instructions provided, but any service operation not described in this manual or in the fixture’s User Guide must be referred to an authorized Martin service technician.



Important! Excessive dust, smoke fluid, and particle buildup degrades performance, causes overheating and will damage the fixture. Damage caused by inadequate cleaning or maintenance is not covered by the product warranty.



Pressing MENU and ENTER buttons immediately when the fixture name appears in the display while powering the fixture on puts the fixture into service mode in which pan and tilt motors are deactivated and SERV appears in the display. To take the fixture out of service mode, power off and then power on again normally.

The ERA 600 Performance / Profile User Guide (available for download from the ERA 600 Performance and Profile pages on www.martin.com) gives full details of the menus in the fixture’s control panel.

The user must clean the ERA 600 Performance / Profile periodically to maintain optimum performance and cooling. The user may also upload firmware (fixture software) to the fixture via the DMX data input port or USB port using firmware and instructions from Martin. All other service operations on the ERA 600 Performance / Profile must be carried out by Martin, its approved service agents or trained and qualified personnel using the official Martin service documentation for the ERA 600 Performance / Profile.

Installation, on-site service and maintenance can be provided worldwide by the Martin Professional Global Service organization and its approved agents, giving owners access to Martin’s expertise and product knowledge in a partnership that will ensure the highest level of performance throughout the product’s lifetime. Please contact your Martin supplier for details.

It is Martin policy to apply the strictest possible calibration procedures and use the best quality materials available to ensure optimum performance and the longest possible component lifetimes. However, optical components are subject to wear and tear over the life of the product, resulting in gradual changes in color over many thousands of hours of use. The extent of wear and tear depends heavily on operating conditions and environment, so it is impossible to specify precisely whether and to what extent performance will be affected. However, you may eventually need to replace optical components if their characteristics are affected by wear and tear after an extended period of use and if you require fixtures to perform within very precise optical and color parameters.

Tilt lock

The tilt position of the head can be locked for service. See Figure 9. Slide the lock button up towards the closed padlock symbol to lock the head and down to unlock.

Important! Release the tilt lock before applying power to the fixture and before packing the fixture in its flightcase.



Figure 9. Tilt lock

Cleaning

Regular cleaning is very important for fixture life and performance. Buildup of dust, dirt, smoke particles, fog fluid residues, etc. degrades the fixture's light output and cooling ability.

Cleaning schedules for lighting fixtures vary greatly depending on the operating environment. It is therefore impossible to specify precise cleaning intervals for the ERA 600 Performance / Profile. Cooling fans suck in airborne dust and smoke particles, and in extreme cases fixtures may require cleaning after surprisingly few hours of operation. Environmental factors that may result in a need for frequent cleaning include:

- Use of smoke or fog machines.
- High airflow rates (near air conditioning vents, for example).
- Presence of cigarette smoke.
- Airborne dust (from stage effects, building structures and fittings or the natural environment at outdoor events, for example).

If one or more of these factors is present, inspect fixtures within their first few hours of operation to see whether cleaning is necessary. Check again at frequent intervals. This procedure will allow you to assess cleaning requirements in your particular situation. If in doubt, consult your Martin dealer about a suitable maintenance schedule.

Follow these precautions when cleaning the fixture:

- Work in a clean, dry, well-lit area.
- Use gentle pressure only. Do not use any product that contains abrasives. Do not use solvents. Use care when cleaning optical components: surfaces are fragile and easily scratched.
- Use a vacuum cleaner – do not use a pressurized air jet. A vacuum cleaner will remove dirt from the fixture and from the area where you are working. An air jet may blow dirt into the fixture, and this can cause visible objects in projections and possibly even damage to the fixture.
- Do not apply a strong vacuum directly to a cooling fan, as the strong airflow may spin the fan blades fast enough to cause damage. Instead, hold the vacuum cleaner nozzle a few centimeters away from the fan and dislodge dust with a soft brush.

Cleaning procedure

To clean the fixture:

1. Disconnect the fixture from power and allow it to cool for at least 30 minutes.
2. Vacuum dust and loose particles from the outside of the fixture and the air vents at the back and sides of the head and in the base, using a soft brush to help dislodge dust.
3. Clean the front glass on the front of the head by wiping gently with a soft, clean, lint-free cloth moistened with a weak detergent solution. Do not rub the surface hard: lift particles off with a soft repeated press. Dry with a soft, clean, lint-free cloth or low-pressure compressed air. Remove stuck particles with an unscented tissue or cotton swab moistened with glass cleaner or distilled water.
4. Check that the fixture is dry before reapplying power.

Lubrication

The ERA 600 Performance / Profile does not require lubrication under normal circumstances. Moving parts can be checked and a long-lasting Teflon-based grease reapplied by a Martin service partner if necessary.

Service utilities

The fixture's **SERVICE** menu provides utilities for technicians rigging or servicing the fixture:

- **PAN/TILT FEEDBACK** lets you disable feedback to the fixture software from the pan, tilt and effects positioning systems. If feedback is set to **ON** and a pan, tilt or effect position error is detected, the shutter closes and the effect resets. This feature can be disabled by setting feedback to **OFF**. The **OFF** setting is not saved when the fixture is powered off, and the system will be re-enabled the next time the fixture starts. If a pan/tilt position error occurs and the system cannot correct pan/tilt position within 10 seconds, feedback is automatically disabled.
- **CALIBRATION** lets you set home positions of pan, tilt, and all the fixture's mechanical effects if the fixture loses adjustment or if you want to adjust effects for specific applications. Adjustment may also be required

by some firmware updates. If so, this will be mentioned in the firmware release notes. See the 'Calibration' section below.

- **USB** lets you see the status of firmware (fixture software) updates. For a detailed guide to updating the firmware, see "Installing using a USB memory device" later in this chapter.

Calibration

Martin fixtures are adjusted and calibrated at the factory, and further calibration should only be necessary if fixtures have been subjected to abnormal shocks during transport or if normal wear and tear has affected alignment after an extended period of use. You can also use calibration to fine-tune fixtures for a particular location or application.

The **SERVICE** → **CALIBRATION** menu lets you define custom offsets in the positions of pan, tilt and all the other effects relative to the DMX values that the fixture receives. This allows you to fine-tune fixtures and achieve uniform behavior in multiple fixtures. The **CALIBRATION** menu also lets you reload the factory default offsets, permanently overwrite the factory default offsets (this command should normally never be used) and set all calibration values to zero.

Defining custom calibration offsets

To adjust the home positions of effects, we recommend the following procedure:

1. Aim a reference fixture and the fixtures that you want to calibrate at a flat surface. You can calibrate fixtures one at a time or line up multiple fixtures in a row. Apply power and set pan, tilt and effects to the same DMX values.
2. In each fixture, scroll through the effects in the **SERVICE** → **CALIBRATION** menu and adjust the position of any effects that you want to calibrate while comparing the light output with the reference fixture. A calibration range of -127 to +128 is available for each effect.
3. After selecting a value, press ENTER to confirm. Note that the value will not be saved until you apply a **SAVE SETTING** command!
4. When you have finished adjusting effects *and before you exit the CALIBRATION menu*, press the MENU button to step back to the main **CALIBRATION** menu. Scroll to **SAVE SETTING**, press ENTER and then when **SAVE** appears in the display press ENTER again to confirm that you want to save all the calibration values that you have just set.

Important! If you do not apply a SAVE SETTING command when you have finished entering custom calibration values as described above, the fixture will delete your custom values and return to the default values stored in memory as soon as you exit the CALIBRATION menu or reboot the fixture.

CALIBRATION → **SAVE SETTING** saves any custom offsets that you have defined as described above so that the fixture keeps the custom offsets when it is powered off and on again. Note that this command does not delete the factory default offsets from memory, so it will still be possible to reload the factory default offsets later if you choose to do so.

Loading default calibration offsets

CALIBRATION → **LOAD DEFAULTS** → **LOAD** lets you permanently erase any custom offsets and restore the default calibration offsets that were set at the factory.

CALIBRATION → **LOAD DEFAULTS** → **SAVE** permanently overwrites the default calibration offsets that were set at the factory with the current custom calibration offsets.

Important! Overwriting the factory default settings with a LOAD DEFAULTS → SAVE command is permanent! You will not be able to reload the factory default offsets later. Factory default offsets should normally only be modified by Martin Service. If you just want to save custom calibration offsets so that the fixture keeps them even after powering off and on, do not use this command. Instead, make your adjustments and then apply a CALIBRATION → SAVE SETTING command.

Setting calibration offsets to zero

CALIBRATION → **CLEAR ALL VALUES** sets all calibration offsets to zero until the fixture is next powered off and on again. If you want the offsets to stay at zero even after a power off/on cycle, you must also apply a **CALIBRATION** → **SAVE SETTING** command.

Installing firmware

Important! Do not switch the fixture off or disconnect the source of the firmware during an update, or the firmware will be corrupted.

You can check the currently installed firmware (fixture software) version in the **INFORMATION** menu in the fixture's control panel.

Fixture information and settings are not affected when you upload new firmware to the fixture.

All ERA 600 Performance / Profile fixtures that are powered on and connected via a DMX link to the fixture that you update will also have their firmware updated.

If you update firmware to a newer version, check the ERA 600 Performance / Profile area of www.martin.com to see whether an updated version of this User Guide is available for the new firmware.

You need the following in order to install firmware:

- A Windows PC running the latest version of the Martin Companion software suite that is available for download from the Martin website at www.martin.com.
- The latest ERA 600 Performance / Profile firmware files. Martin Companion automatically downloads these from the Martin fixture firmware cloud when you run it on a PC that is connected to the Internet.
- Either:
 - a Martin Companion Cable USB-DMX hardware interface (see "Accessories" on page 37), or
 - a USB flash memory drive formatted in Windows using the FAT32 file system.

Installing using a Martin Companion Cable

To install the ERA 600 Performance / Profile firmware using a Martin Companion Cable:

1. Apply power to the ERA 600 Performance / Profile fixture(s) and allow it to boot.
2. Connect the Martin Companion Cable's USB connector to a USB port on your PC. Connect the Martin Companion Cable's XLR connector to either the fixture's DMX IN connector or the DMX link.
3. Start the PC and launch Martin Companion. Check that the Martin Companion application correctly detects the Martin Companion Cable (a green dot should appear next to **USB Connected** in the top right-hand corner of the window).
4. Locate the latest ERA 600 Performance / Profile firmware in Martin Companion (**Firmware** → **ERA** → **ERA 600 Performance / Profile**).
5. Start the firmware update by clicking **Update Firmware** in Martin Companion. Do not disconnect the Martin Companion Cable or power off the fixture(s) until the upload is complete and the fixture(s) has successfully rebooted.
6. If you are updating multiple fixtures over a DMX link, check that they have all rebooted correctly.

Installing using a USB memory device

To install the ERA 600 Performance / Profile firmware using a USB flash memory drive:

1. Launch the Martin Companion software suite on a PC that is connected to the Internet. Martin Companion will automatically download the latest Martin firmware files from the Martin cloud.
2. In Martin Companion's **Fixture Update** window, click on **Download USB Stick Firmware** and navigate to the root directory of the USB drive where you want to save the firmware.
3. Click on **Select Folder**. Martin Companion will automatically save the firmware files in a correctly named folder to the USB drive's root directory.
4. When you see a **Download Successful** message you can close Martin Companion. Check that the USB drive now contains a folder whose name is the fixture type and software version. Then use an **Eject** command in Windows to make sure that you can remove the drive safely, and remove the drive from the PC.
5. Apply power to the fixture and allow it to boot. Insert the USB drive into the USB host socket next to the fixture's control panel. The fixture should illuminate the display and the contents of the root directory should appear in the display. If the fixture does not recognize the USB drive automatically, navigate to **SERVICE** → **USB** in the control panel.
6. Scroll to the folder that contains the update files on the USB drive. Select the folder and press **ENTER**. The update will begin automatically and the display will show progress status. At the end of the update process the fixture(s) will reboot. Do not remove the USB drive until the fixture has successfully rebooted.

7. Remove the USB drive from the fixture. The newly-installed firmware version will now be displayed in the **INFORMATION** menu.
8. If you are updating multiple fixtures over a DMX link, check that they have all rebooted correctly.

Rotating gobo replacement

Gobo Wheel 1 (in both the ERA 600 Performance and the ERA 600 Profile) and Gobo Wheel 3 (in the ERA 600 Profile only) are rotating gobo wheels. The gobos on Gobo Wheels 1 and 3 have the same dimensions and specifications and are interchangeable, but the goboholders have slightly different designs and cannot be swapped from one wheel to the other.

The ERA 600 Performance / Profile uses specially designed borosilicate 3.3 rotating gobos with a heavy matted aluminum coating. All gobos are interchangeable, but replacement gobos must match the dimensions, construction and quality of the gobos supplied as standard. The gobos are a custom size: 23.0 mm +0/-0.2 mm external diameter, 19 mm image diameter.

Optical components have fragile coatings and are exposed to very high temperatures. Handle and store components with care.

See the ERA 600 Performance / Profile User Guide (available for download from the products' pages on www.martin.com) for names, illustrations and part numbers of the gobos installed as standard.

Avoiding damage to gobos

Follow these precautions when handling, using and storing gobos:

- Do not use gobos with dark coatings on either side, as these will absorb heat – either directly from the light source or reflected back from other optical components – and will not be durable.
- Do not use metal gobos in the ERA 600 Performance / Profile: their durability may be reduced when used in this fixture.
- Store all gobos in a dust-free environment with approx. 50% humidity.
- Wear clean nitrile cleanroom gloves when handling gobos.
- Avoid scratching coated and uncoated sides.
- Do not place a gobo with the coated side face-down on any surface.
- Avoid touching the other gobos when removing a gobo from a rack: the sharp edge of one gobo can scratch the others.
- Keep gobos perfectly clean to reduce the risk of heat damage.
- When cleaning gobos, use a repeated dabbing action rather than a rubbing action. When rinsing, use distilled or even better deionized water to avoid residue that will appear as drying marks.
- If possible, clean the coated side of gobos with dust and oil-free compressed air only. If the coated side is contaminated with oil, clean with isopropyl alcohol and optics cleaning tissues.
- Clean the uncoated side of gobos with isopropyl alcohol or photographic quality lens-cleaner and optics cleaning tissues.
- Do not try to clean gobos in an ultrasound bath, as this may cause delamination of the coating.
- Do not use acidic or alkaline cleaning solutions, as they will attack the aluminum coating.
- Correct gobo orientation is critical. Read the guidelines given later in this chapter carefully before installing a gobo.

Opening the head for access

To open the head for access to the rotating gobos:

1. Disconnect the fixture from power and allow to cool for 30 minutes.
2. Place the fixture on a suitable work surface.

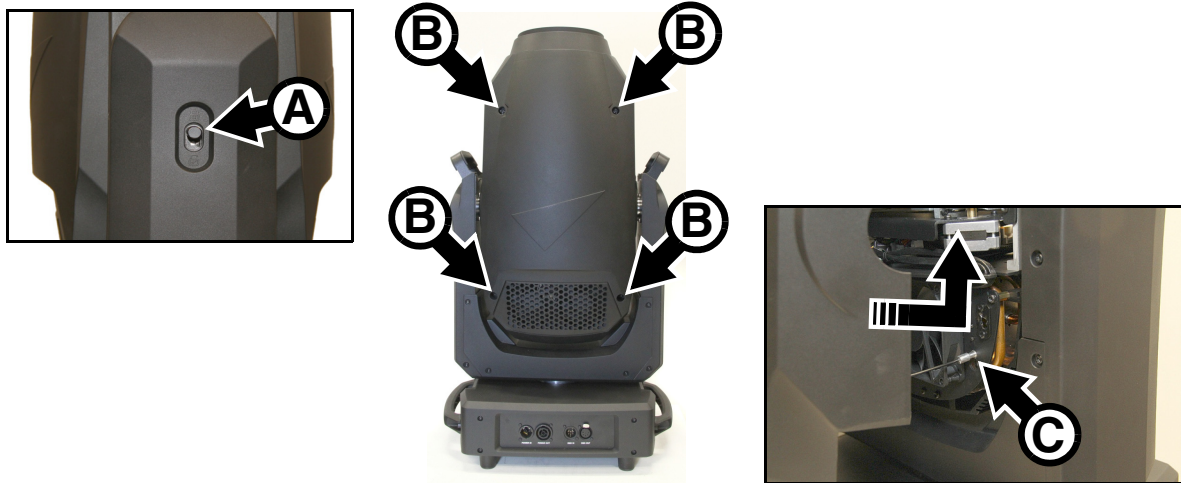

Figure 10: Removing the head covers

3. See Figure 10. Apply the tilt lock **A**.
4. Remove the four retaining screws **B** from one of the head covers and lift the cover away from the head slightly. Press the retaining clip **C** on the cover's safety wire in towards the head chassis, slide the clip until you can remove it, and then remove the safety wire and head cover completely from the fixture.
5. Remove the other head cover in the same way.

When closing the head, follow the above procedure in reverse. Check that the head covers are held securely after you have reinstalled them, and release the tilt lock before reapplying power or packing the ERA 600 Performance / Profile in its flightcase.

Replacing a rotating gobo on Gobo Wheel 1

The photos in this section show an ERA 600 Performance, but the procedure for replacing a gobo on Gobo Wheel 1 is the same in Performance and Profile fixtures.

To replace a rotating gobo on Gobo Wheel 1:

1. Remove both head covers as described in the previous section.

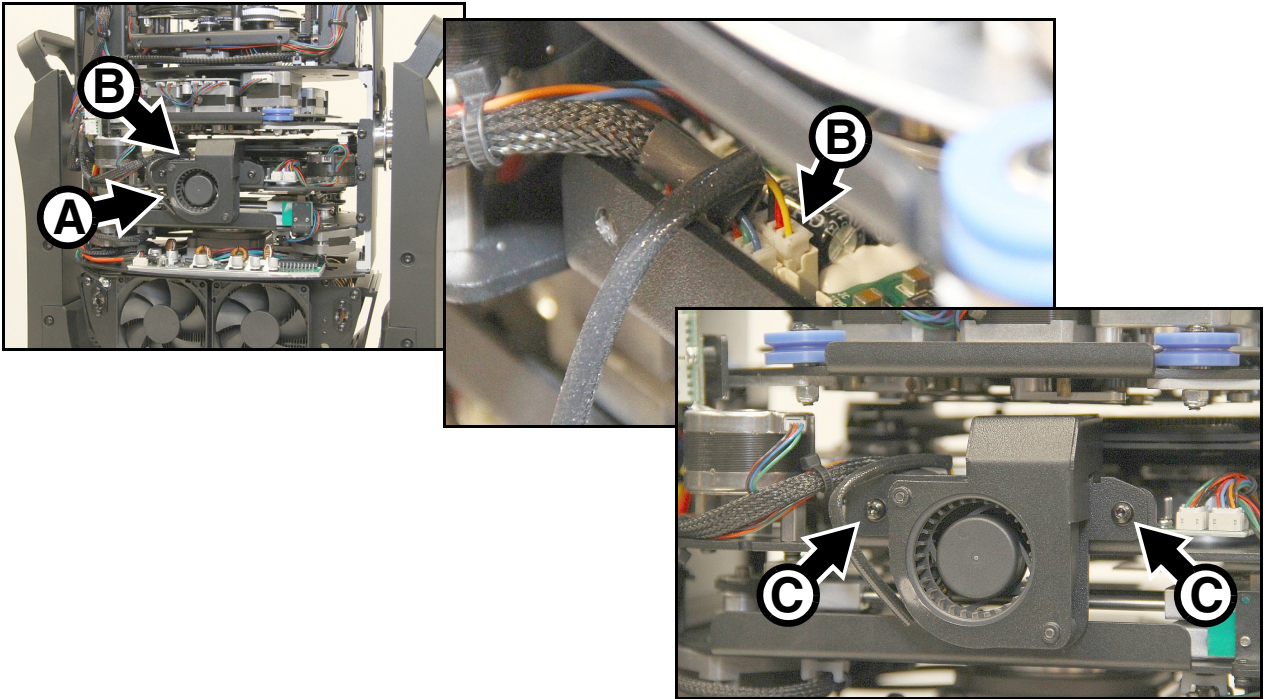

Figure 11: Removing the effects fan

2. See Figure 11. Position the head so that the effects cooling fan **A** is facing you. You are now looking at the bottom of the head.
3. Unplug the effects fan connector **B**, remove and keep the fan's two retaining screws **C** and remove the fan from the head.
4. See Figure 12. Locate the main effects module connector (arrowed) and disconnect it from the PCB on the left of the head. Let the connector and wireset hang free.

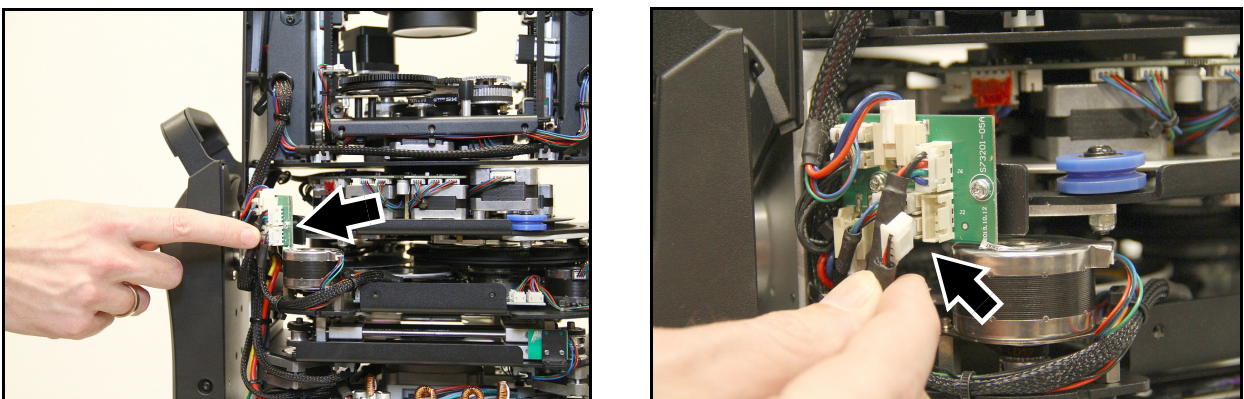

Figure 12: Disconnecting the effects module

5. See Figure 13. Rotate the head through 180° so that you are looking at the top of the head. Remove the six screws (arrowed) from the effects module retaining plates and keep the plates and screws for re-use. The retaining plates that you must remove from the top of the head are marked **Service here** to help avoid confusion with the similar plates in the bottom of the head.

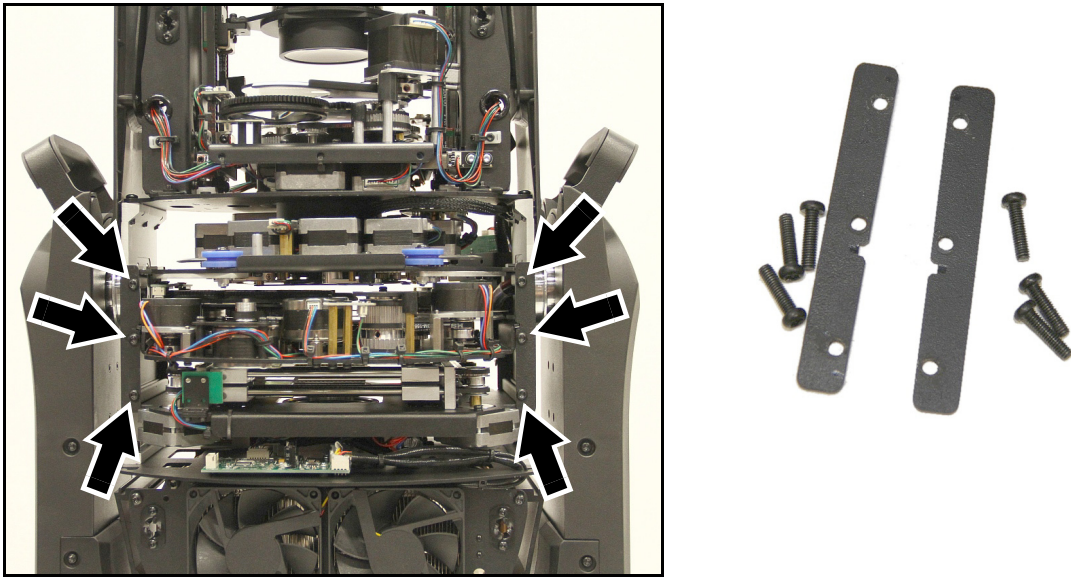

Figure 13: Removing the effects module retaining plates

6. See Figure 14. Slide the effects module carefully out of the head. If any wires or components become caught, especially on the module above, move them out of the way.

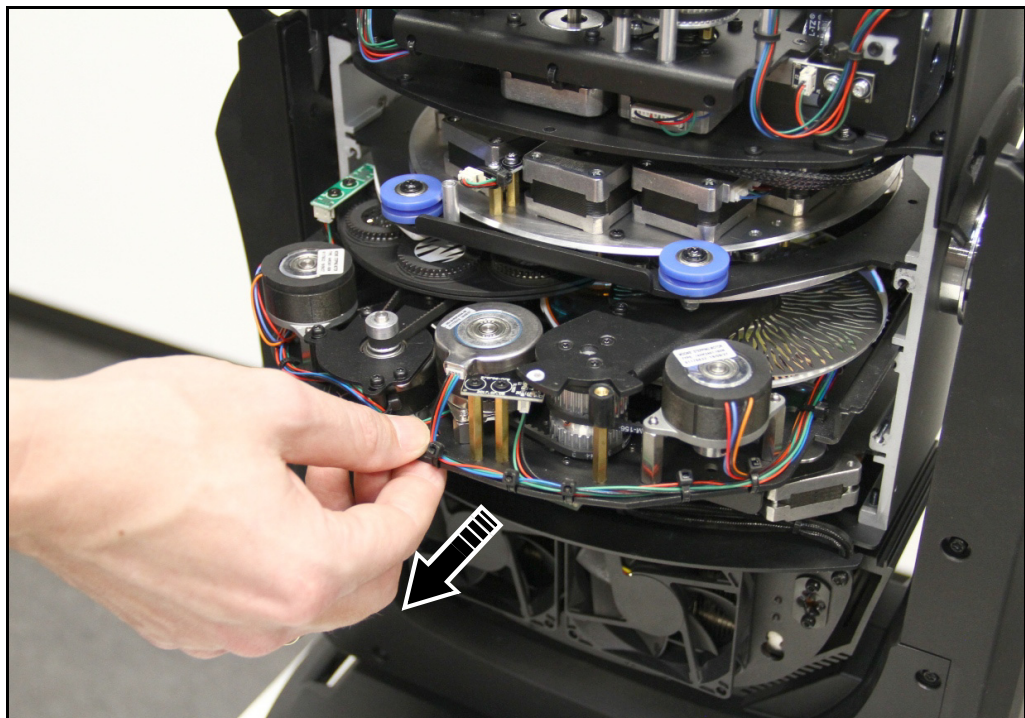

Figure 14: Removing the effects module

7. Place the effects module on a clean work surface with the rotating gobo wheel facing upwards.

- See Figure 15. Note the position of the reference marks in the gobo drive wheel **A** and goboholder **B**. Note also the position of the goboholder positioning magnet **C** and gobo wheel positioning magnet **D**. Each time you remove a goboholder from the wheel, turn the drive wheel (twice if necessary) until the marks exactly line up.

We recommend that you only remove one goboholder at a time. Avoid turning the drive wheel while a goboholder is out of the gobo wheel. This will keep the gobos in their correct orientation, avoiding the need to reprogram cues or adjust gobo positions in the fixture because a gobo orientation has changed during service. Note that if necessary you can adjust the home positions of rotating gobos at any time using the SERVICE → CALIBRATION menu in the control panel.

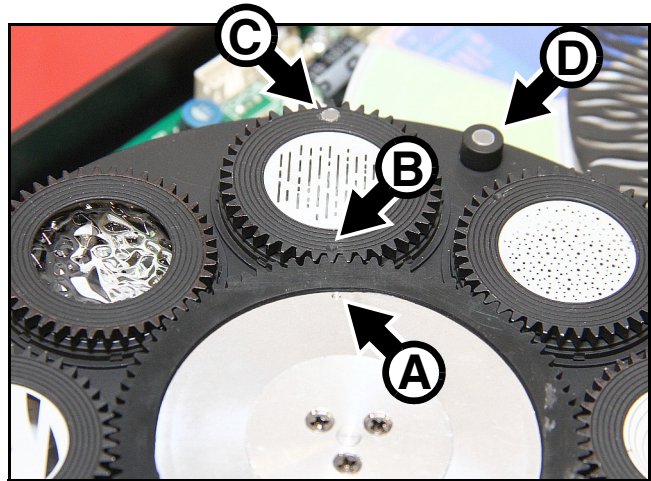

Figure 15: Goboholder orientation marks

- See Figure 16. With the reference marks lined up, lift the outside edge of the goboholder up slightly and pull the goboholder out of the gobo wheel. Note how the goboholder tongue (arrowed) engages in a recess in the gobo drive wheel. You will need to reinstall the goboholder with the tongue in the same position in the drive wheel.

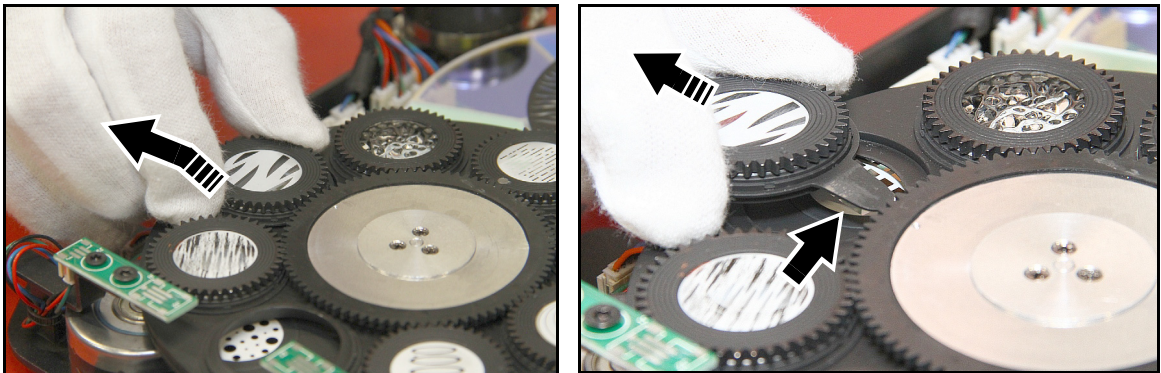

Figure 16: Removing a rotating gobo

- For details of replacing a gobo in a goboholder, see “Installing a gobo in a goboholder” on page 26.
- When reinstalling a goboholder in the gobo wheel, use the above procedure in reverse as a guide. Do not apply lubricant to any part of the goboholders or gobo wheel. The cogs are designed to run without lubricant. Line up the reference marks in the goboholder and gobo drive wheel and push the tongue correctly into its location in the gobo drive wheel when you install the goboholder. Check that the goboholder is held securely in the wheel after you have installed it.

Replacing a rotating gobo on Gobo Wheel 3 (ERA 600 Profile only)

The ERA 600 Profile has a second rotating gobo wheel which is referred to as Gobo Wheel 3. To replace a gobo in Gobo Wheel 3:

1. Remove the head covers as described earlier in this chapter.
2. Remove Gobo Wheel 1 from the fixture as described earlier in this chapter. See Figure 17. You now have access to the rotating gobos in Gobo Wheel 3 (arrowed) without any need to remove this gobo wheel from the fixture.
3. To remove a gobo from Gobo Wheel 3, see Figure 18. If you want to minimize the need to calibrate the gobo's position in the control menus, rotate the gobo until you line up reference points (such as the markings in the gobo wheel and on the goboholder shown at **A** and **B** in Figure 15 on page 24). Pull the top of the gobo away from the gobo wheel until it clears the circular hole in the wheel, then lift the gobo out of the gobo wheel.

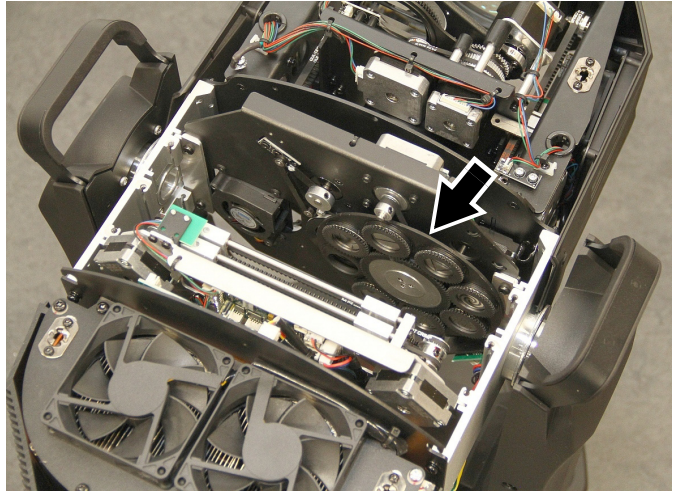

Figure 17: Gobo Wheel 3

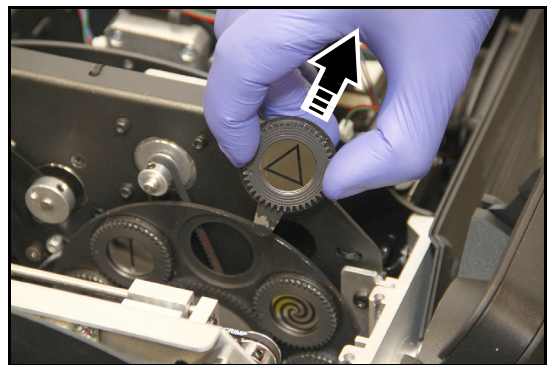
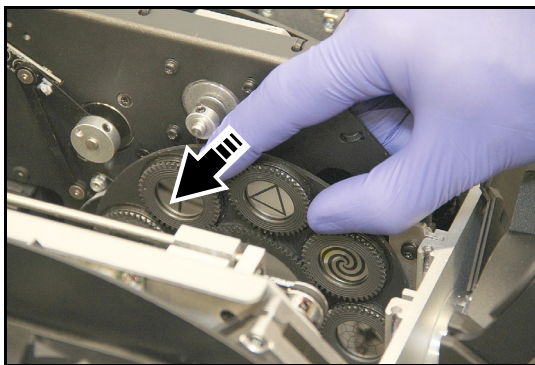

Figure 18: Removing a gobo from Gobo Wheel 3

To reinstall the goboholder in the gobo wheel and reassemble the fixture, use the above procedure in reverse as a guide.

When you reinstall the goboholder, line up any reference points that you noted. See Figure 19. Note the position of the slot (arrowed) in the gobo wheel. When you slide the goboholder into the wheel, make sure that you insert the tongue on the goboholder into this slot.

Check that the goboholder is held securely in the wheel and rotates freely after you have installed it.

Do not apply lubricant to any part of the goboholders or gobo wheel. The cogs are designed to run without lubricant.

If you have not managed to physically line up a gobo as you want it, you can open the **SERVICE** → **CALIBRATION** control menu after you have reassembled the fixture and adjust the position of the gobo.

For details of replacing a gobo in a goboholder, see "Installing a gobo in a goboholder" on page 26.

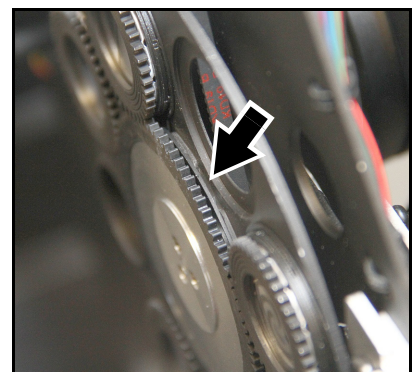

Figure 19: Slot for goboholder

Installing a gobo in a goboholder

All the rotating gobos in the ERA 600 Performance / Profile are held in their holders by springs and can be removed from their holders as described below.

Note that the textured glass gobo Limbo (Crystal) on Gobo Wheel 1 has a specially designed goboholder to cater for the extra thickness of the fused glass and is glued into its goboholder. Textured glass gobos and their goboholders are not interchangeable with the other gobos and goboholders.

Gobo orientation

Make sure that you install gobos facing in the correct direction, or they may suffer heat damage. The orientations shown in Figure 20 are correct in most cases, but consult your Martin dealer or gobo supplier if you are in any doubt about the orientation of a specific gobo type.

Coated Glass Gobos

The heavy matted aluminum coated borosilicate gobos in the ERA 600 Performance / Profile are factory-installed with the more reflective sides facing towards the LED light source. Replacement gobos must also be installed with more reflective sides facing the LEDs in order to avoid heat damage.

More reflective side towards LEDs

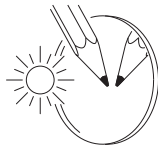

To minimize the risk of gobo overheating and damage, turn the more reflective side of a coated gobo towards the lamp.

Less reflective side away from LEDs

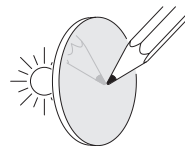

The less reflective side of a coated gobo will absorb less heat if it faces away from the lamp.

Textured Glass Gobos

Flat side towards goboholder

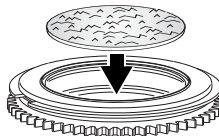

Textured glass gobos sit most squarely in the goboholder with the flat side placed down into the recess in the goboholder. If in doubt, consult your Martin dealer or gobo supplier. We recommend that textured glass gobos are glued into the goboholder.

Image / text Gobos

True image towards LEDs

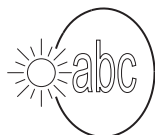

Reversed image away from LEDs

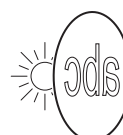

Gobos that have a specific left/right orientation (such as text gobos) will appear correctly in the projection if they appear correctly when viewed from the side that faces towards the LED light source.

Figure 20. Correct gobo orientation

Goboholder and gobo orientation – Gobo Wheel 1 (Performance and Profile fixture types)

On *Gobo Wheel 1* in ERA 600 Performance and Profile fixtures:

- The side of the goboholder with the gobo retaining spring faces towards the LED light source.
- The side of the goboholder with the teeth faces towards the front glass.
- The shiny side of the gobo must face towards the spring in the goboholder as shown in Figure 21 so that it will face towards the LED light source. The white side of the gobo must face away from the spring.
- Images or text on gobos must appear correctly (and not flipped left to right) when looking at the goboholder from the side with the spring.
- The textured side of textured glass gobos must face towards the spring. The flat side of textured gobos must face downwards so that the gobo sits flat in the goboholder.

Goboholder and gobo orientation – Gobo Wheel 3 (Profile fixture type)

On *Gobo Wheel 3* in ERA 600 Profile fixtures:

- The side of the goboholder with the gobo retaining spring faces towards the front lens.
- The side of the goboholder with the teeth faces towards the LED light source.
- The white side of the gobo must face towards the spring in the goboholder. The shiny side must face away from the spring so that it will face towards the LED light source.
- Images or text on gobos must appear flipped left to right when looking at the goboholder from the side with the spring.
- The textured side of textured glass gobos must face towards the spring. The flat side of textured gobos must face downwards so that the gobo sits flat in the goboholder.

Gobo alignment

See Figure 21 (Gobo Wheel 1 shown). Note the position of the alignment marks (arrowed) on goboholders and gobos. Install gobos with the alignment marks next to each other.

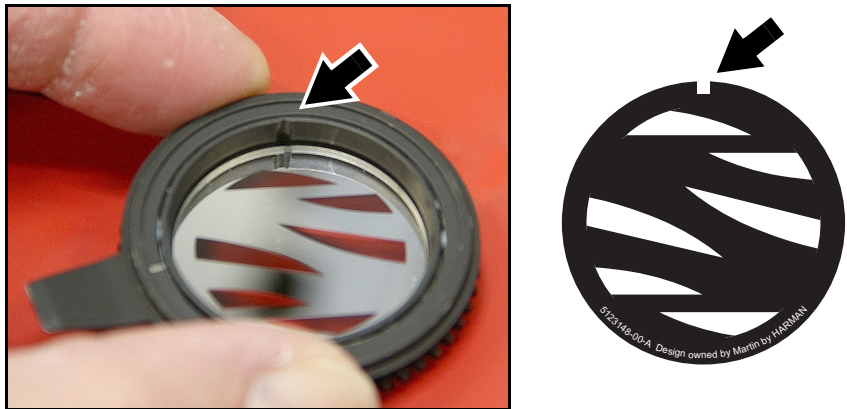

Figure 21: Gobo alignment marks

Gobo replacement procedure

Avoid getting grease from your fingers or dirt onto gobos. Hold gobos by their edges only. Wear nitrile cleanroom gloves when handling gobos.

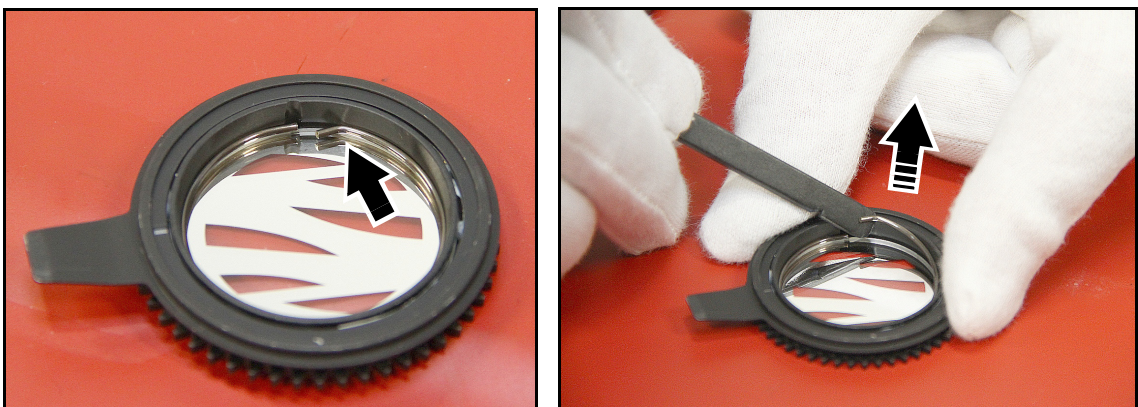

Figure 22: Removing a gobo from a goboholder

To replace a gobo in a goboholder:

1. See Figure 22. Place the goboholder on a clean surface with the teeth side facing downwards. Note the position of the bend (arrowed) in the end of the gobo retaining spring. Using a plastic lever to avoid scratching the gobo, lever the end of the retaining spring out of the groove in the goboholder and lift the retaining spring out of the goboholder.
2. Turn the goboholder teeth side up and let the gobo fall out of the holder onto a clean, soft surface. Put the goboholder on the surface teeth side down again.
3. Holding the new gobo by its edges, insert it into the goboholder with the alignment marks on gobo and goboholder oriented correctly. On Gobo Wheel 1 the shiny side must face upwards as shown in Figure 21. On Gobo Wheel 3 the shiny side must face downwards. Check that the gobo is fully seated in the holder.
4. Insert the retaining spring into the goboholder and press it into its groove in the goboholder. Check that the spring is pressed as flat as possible against the gobo and that the gobo is held securely in the goboholder.
5. Reinstall the goboholder in the gobo wheel.
6. Reinstall Gobo Wheel 1 in the head following the procedure given in "Replacing a rotating gobo on Gobo Wheel 1" on page 22 in reverse.
7. When service work is finished, reinstall the head covers using the section "Opening the head for access" on page 21 as a guide.

Converting between Performance and Profile

The framing module in the ERA 600 Performance and the second rotating gobo wheel (Gobo Wheel 3) in the ERA 600 Profile are interchangeable. This means that you can convert an ERA 600 fixture from a Performance to a Profile model and vice versa by removing one of these modules and replacing it with the other type. Effects modules are available from your Martin supplier (see “Accessories” on page 37).

From ERA 600 Performance / Profile fixture software version 2.2.0 onwards the fixture will automatically detect which module is installed and adapt the fixture’s DMX control options, menu structure and personality accordingly. The fixture type Performance or Profile appears in the fixture’s control panel display briefly when the fixture starts up. To see the fixture type at any time, open the **INFORMATION** menu in the control panel, scroll to **FIXTURE TYPE** and press ENTER.

The calibration data for effects modules is stored in the fixture’s memory, not in the modules. To keep the original factory calibration settings if you remove a module and then reinstall it, make sure that you return the module to the fixture that it originally came from.

Whenever the original factory-installed module is replaced by another module for the first time, it is necessary to calibrate the new module. The fixture can store the calibration settings for one module of each type (e.g. one framing module and one Gobo Wheel 3 module).

The procedure in the next section covers conversion from an ERA 600 Profile configuration to an ERA 600 Performance configuration by removing the Profile’s second rotating gobo wheel and replacing it with the Performance’s framing module, but the procedure is essentially the same whether you convert from Profile to Performance or convert from Performance to Profile.

Converting from Profile to Performance

To convert an ERA 600 Profile to an ERA 600 Performance by removing the second rotating gobo wheel (Gobo Wheel 3) and replacing it with a framing module:

1. Disconnect the fixture from power, allow it to cool for 30 minutes and place it on a suitable work surface.
2. Remove the head covers as described in “Opening the head for access” on page 21.
3. Tilt the head so that the side with the effects module cooling fan is facing upwards. This is the bottom of the head.
4. See Figure 23. Locate the effects connections PCB **A**, then:
 - disconnect the main effects module by removing the multi-pin connector marked **GOBO** from plug **J2** and
 - disconnect the Gobo Wheel 3 wheel module marked **DATA** (or the framing module marked **BLADE** if you are converting from a Performance to a Profile model) by removing the multi-pin connector from plug **J6**.
5. Remove the two Torx screws **B** that hold the effects module cooling fan bracket in position and leave the fan resting on top of the main effects module.

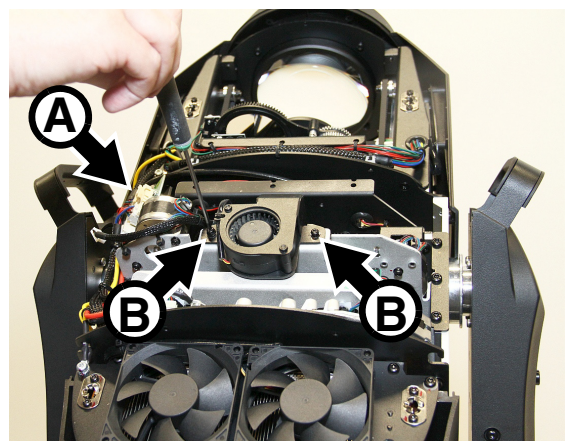
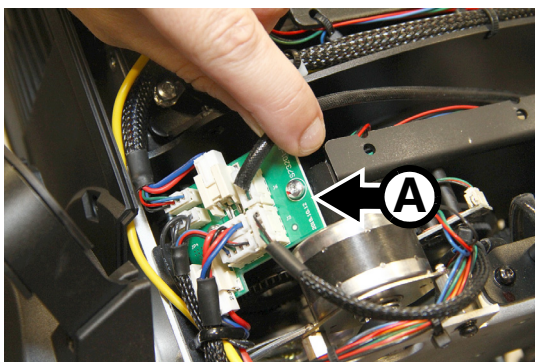

Figure 23: Removing the effects module cooling fan

6. Tilt the head around to give you access to the other side of the head (the top of the head). You can let the effects module cooling fan that you have just unfastened hang underneath the fixture, but avoid pulling on the fan wiring.

7. See Figure 24. Remove the six Torx screws (arrowed) that hold the effects module retaining plates on the head chassis and remove both plates. Note that the correct plates are marked **Service here**. Do not confuse them with the similar unmarked plates on the other side of the head. Keep the plates and screws for re-use.
8. Lift the main effects module together with its cooling fan out of the head. Make sure that the fan does not catch on its way through the head, or you may damage the fan wiring.

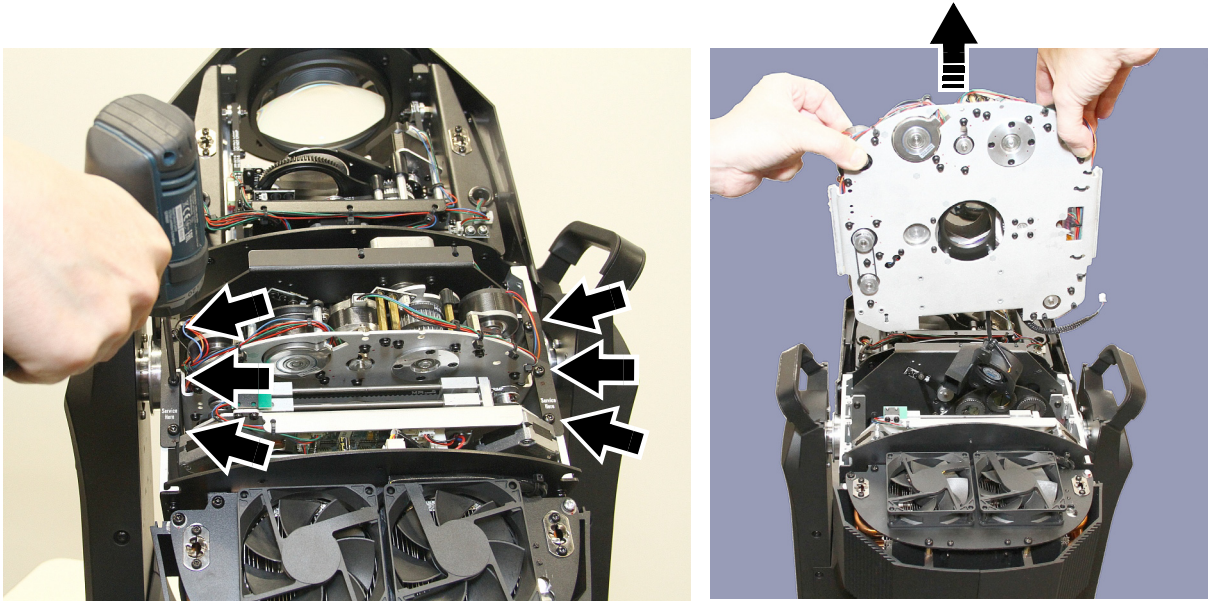

Figure 24: Removing the main effects module

9. See Figure 25. Slide the focus car towards the front of the head with one hand. With the other hand, lift the Gobo Wheel 3 module (or the framing module if you are converting from a Performance to a Profile model) out of the fixture.

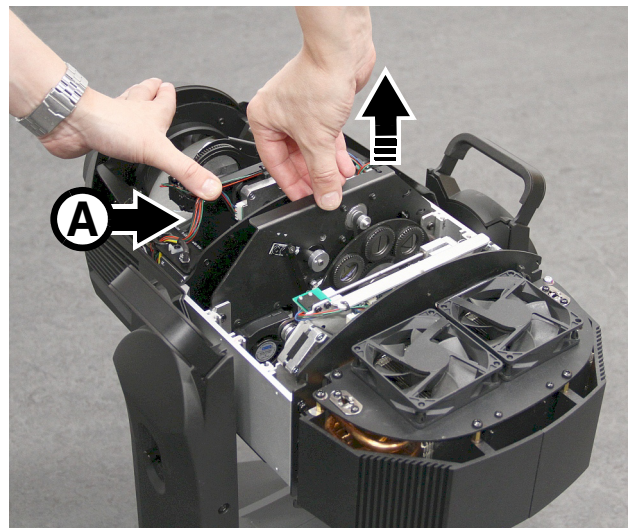

Figure 25: Removing the Gobo Wheel 3 module

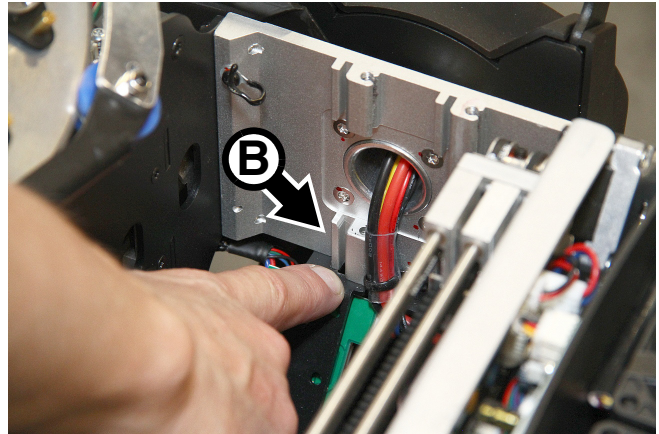
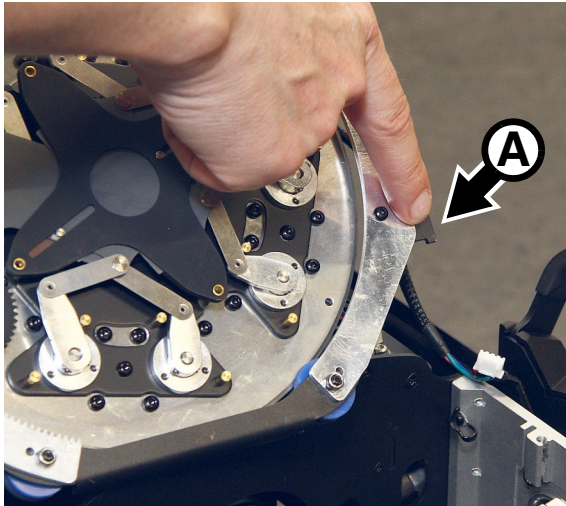

Figure 26: Framing module guide channels

10. See Figure 26. Note the positions of the locating tabs **A** on both sides of the framing module and the guide channels **B** on both sides of the head, closest to the front of the head.
11. See Figure 27. Slide the focus car towards the front of the fixture and lower the framing module into the head, making sure that the module's locating tabs engage in the guide channels and that you do not trap any wires (see photo **C**).
12. Lower the main effects module into the head, making sure that the module's locating tabs engage in the guide channels (see photo **D**). Make sure that the cooling fan passes through the head without catching or snagging and make sure that you do not trap any wires. Check that the module is correctly located in the head.

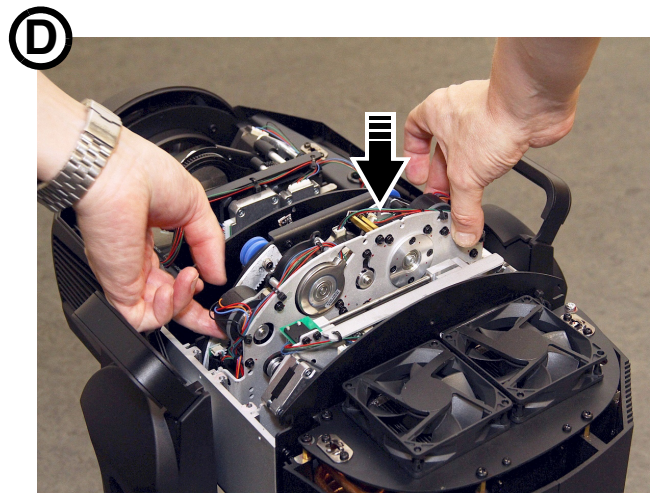
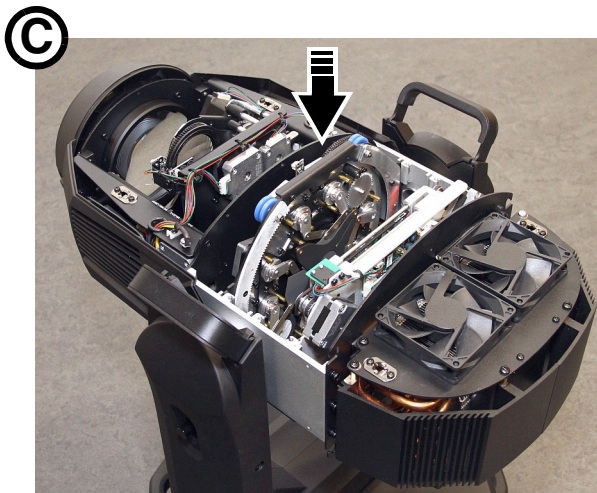

Figure 27: Installing the framing module and main effects module

13. See Figure 28. Reinstall the effects module retaining plates **A** using the original six Torx screws to fasten them into position.

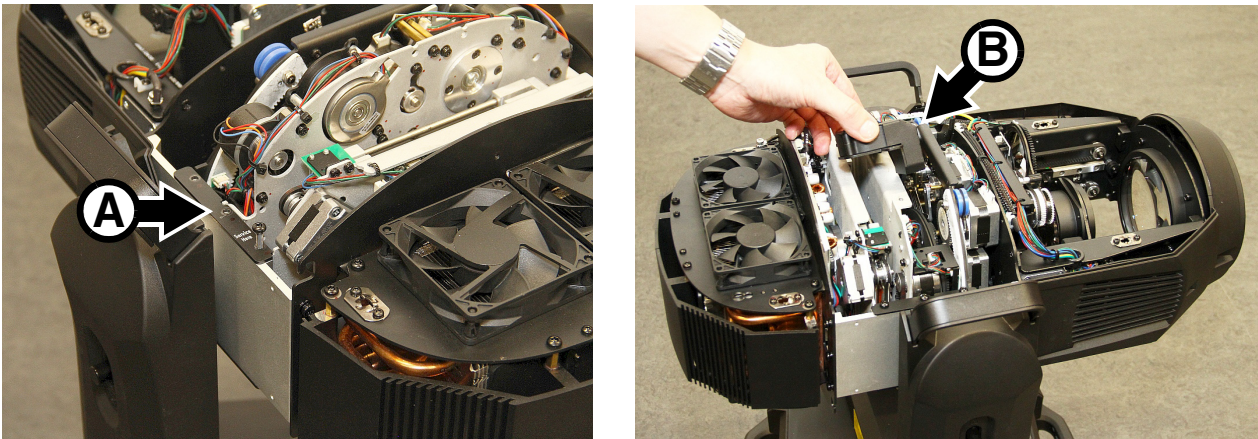

Figure 28: Reinstalling the effects module brackets and cooling fan

14. Tilt the head around so that you have access to the other side (the bottom) of the head. Reinstall the effects modules cooling fan **B** using the original two Torx screws to fasten the fan bracket into position.

15. See Figure 29. On the effects modules connector PCB, connect the modules as follows:

- Connect the main effects module multi-connector marked **GOBO** to the socket marked **J2**.
- Connect the framing module multi-connector marked **BLADE** (or the Gobo Wheel 3 module multi-connector marked **DATA**) to the socket marked **J6**.

16. When service work is finished, reinstall the head covers using the section “Opening the head for access” on page 21 as a guide.

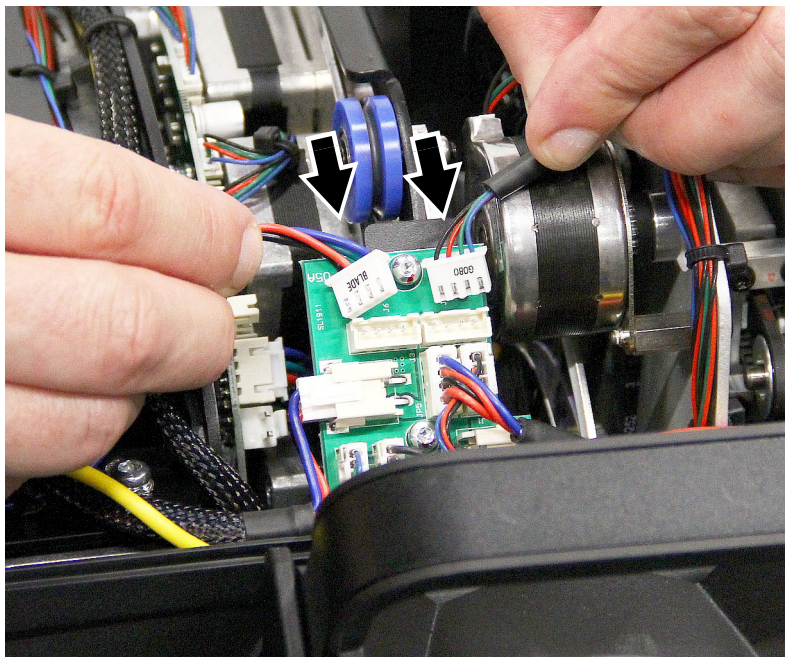

Figure 29: Reconnecting the effects modules

Using the fixture

Before using the fixture, download and read the latest version of the ERA 600 Performance / Profile User Guide from the ERA 600 Performance / Profile area of the Martin website at www.martin.com. The User Guide contains details of:

- The effects available in the fixture.
- The control options available using DMX and/or RDM.
- The setup, monitoring and control options available using the onboard control and display panel.
- Software service functions.

Applying power



Warning! Before applying power to the fixture:

- **Read the safety information section of this manual starting on page 4.**
- **Read “Connecting to power” on page 14.**
- **Check that the installation is safe and secure.**
- **Check that the base is fastened securely so that the torque reaction when the head moves will not cause the base to move.**
- **Check that the head tilt lock is released (see “Tilt lock” on page 9).**
- **Be prepared for the fixture to light up suddenly. Check that no-one is looking at the fixture from close range.**
- **Be prepared for the head to move suddenly. Check that there will be no risk of collision with persons or objects.**

The ERA 600 Performance / Profile does not have an On/Off switch. To apply power to the fixture, apply power to the power input cable. Neutrik powerCON TRUE1 connectors also support hot-plugging.

ERA 600 Profile battery power

The ERA 600 Profile has an onboard lithium battery that gives access to the most important functions in the control panel when the fixture is not connected to AC mains power.

The battery is charged automatically when the fixture is connected to mains power. It will normally hold a charge for 3 months. If the fixture is new or has been in storage, connecting to mains power for 2 hours will normally be enough to fully recharge the battery.

The following functions are available on battery power:

- DMX address
- Fixture ID
- PERSONALITY menu
- DEFAULT SETTINGS command
- INFORMATION menu
- Error status messages (if any of these have been logged and stored in memory)

To activate the display when the fixture is not connected to mains power, press MENU. Press MENU again to enter the menus.

The display extinguishes after 10 seconds with no user input and the control panel is de-activated after one minute with no user input. Press MENU again to re-activate.

Troubleshooting

Problem	Probable cause(s)	Remedy
One or more of the fixtures is completely dead.	No power to fixture.	Check that power is switched on and cables are plugged in.
	Fuse blown or internal fault.	Contact Martin Service or authorized service partner. Do not remove base or yoke covers, attempt to replace a fuse or carry out any repairs or service that are not described in this Safety and Installation Manual unless you have both authorization from Martin and official Martin service documentation.
Fixtures reset correctly but respond erratically or not at all to the controller.	Bad data link.	Inspect connections and cables. Correct poor connections. Repair or replace damaged cables.
	Data link not terminated.	Insert DMX termination plug in data output socket of the last ERA 600 Performance / Profile on the data link.
	Incorrect addressing of fixtures.	Check fixture address and protocol settings.
	One of the fixtures is defective and is disturbing data transmission on the link.	Unplug the XLR in and out connectors and connect them directly together to bypass one fixture at a time until normal operation is regained. Have the fixture serviced by a qualified technician.
Timeout error after fixture reset.	Effect requires mechanical adjustment.	Check fixture's stored error messages for more information. Contact Martin Service or authorized Martin service partner.
Mechanical effect loses position.	Mechanical train requires cleaning, adjustment, or lubrication.	Check fixture's stored error messages for more information. Contact Martin Service or authorized Martin service partner.
Light output cuts out intermittently.	Fixture is too hot.	Check fixture's stored error messages for more information. Allow fixture to cool. Clean fixture. Reduce ambient temperature.

Table 2: Troubleshooting

Specifications

Physical

Length (head)	544 mm (21.5 in.)
Width (base)	290 mm (11.4 in.)
Length (base)	416 mm (16.4 in.)
Width (across yoke)	390 mm (15.4 in.)
Height (head straight up)	734 mm (28.9 in.)
Height (maximum)	745 mm (29.4 in.)
Minimum center-to-center distance in side-by-side installation	660 mm (26.0 in.)
Weight, ERA 600 Performance	32.3 kg (71.3 lbs.)
Weight, ERA 600 Profile	31.3 kg (69.0 lbs.)

Dynamic Effects

ERA 600 Performance and ERA 600 Profile

Electronic 'shutter' effect	Strobe effect, pulse effects, instant open and blackout
Electronic dimming	0 - 100%, four dimming curve options
Color mixing	CMY, independently variable 0-100%
Color temperature control	Variable 6500 - 2700 K
Color wheel	7 color filters plus open
Rotating gobo wheel	7 gobos plus open, wheel rotation, gobo rotation, indexing and shake
Static gobo wheel	8 gobos plus open, wheel indexing, rotation and shake
Gobo animation	Animation wheel, indexing, continuous rotation with variable speed and direction
Iris	0-100%
Zoom	Motorized
Focus	Motorized
Prism	2 rotating/indexing prisms (4-facet circular and 6-facet linear)
Frost	Heavy frost effect
Pan	540°, coarse & fine control and speed
Tilt	260°, coarse & fine control and speed

ERA 600 Performance only

Framing	Rotatable framing module, +/-60°, with 4 individually controllable full framing blades with variable angle and position
---------	---

ERA 600 Profile only

Second rotating gobo wheel	7 gobos plus open, wheel rotation, gobo rotation, indexing and shake
----------------------------	--

Control and Programming

Control options	DMX
16-bit control	Dimming, CMY, CTO, pan and tilt
Setting and addressing	Control panel with backlit LCD display
DMX channels, ERA 600 Performance	41
DMX channels, ERA 600 Profile	35
DMX compliance	USITT DMX512/1990
RDM compliance	ANSI/ESTA E1.20
Transceiver	Opto-isolated RS-485

Optics

Front lens diameter	120 mm (4.75 in.)
Zoom range	6° - 45° (1:7.5)
Light source	550 W LED engine
LED refresh rates	3600 Hz, 1200 Hz in theater (low-noise) mode
Minimum LED lifetime	20 000 hours (to >70% luminous output)*

*Figure obtained under manufacturer's test conditions

Photometric Data

Light engine luminous output	37 000 lumens
Fixture luminous output	19 000 lumens
CCT (Calibrated Color Temperature)	6500 K (+/-250K)
CRI (Color Rendering Index)	>70

Construction

Housing	High-impact flame-retardant thermoplastic
Color	Black
Protection rating	IP20

Gobos

External diameter	23.0 mm +0 / -0.2 mm (0.906 in. +0 / -0.008 in.)
Maximum image diameter	19 mm (0.75 in.)
Maximum gobo thickness	1.1 mm (0.04 in.)
Material	Borofloat 33
Coating	Heavy matted aluminum

Installation

Mounting points	2 pairs of 1/4-turn points for 106 mm (4.17 in.) center-to-center omega brackets
Location	Dry location only, must be fastened to surface or structure
Orientation	Any
Minimum distance to combustible materials	0.2 m (8 in.)
Minimum distance to illuminated surfaces	2.0 m (6.6 ft.)

Connections

AC mains power input	Neutrik TRUE1 socket, accepts TRUE1 NAC3FX-W (TOP) connector
AC mains power throughput	Neutrik TRUE1 socket, accepts TRUE1 NAC3MX-W (TOP) connector
DMX and RDM data in/out	5-pin locking XLR

Electrical

AC power	100-240 VAC (nominal), 50/60 Hz
Power supply unit	Auto-ranging electronic switch mode
Maximum total power consumption	856 W
Power consumption, all effects static, zero light output	64 W
Half-cycle RMS inrush current at 230 V, 50 Hz	21.8 A
Recommended MCB (Miniature Circuit Breaker) per IEC 60898/UL489/CSA C22.2 No. 5	Type D

Typical Power and Current

120 V, 60 Hz	6.5 A, 778 W, PF 0.994
230 V, 50 Hz	3.2 A, 760 W, PF 0.967

Figures are typical, not maximum. Measurements made at nominal voltage with all LEDs at full intensity.

Allow for a deviation of +/- 10%. PF = power factor

Thermal

Cooling	Forced air (temperature-regulated, low noise)
Maximum surface temperature, steady state, at Ta 40° C	75° C (167° F)
Maximum ambient temperature (Ta max.)	40° C (104° F)
Minimum ambient temperature (Ta min.)	5° C (41° F)
Maximum total heat dissipation (calculated, +/- 10%)	2920 BTU/hr.

Approvals



Global CB Certification/IECEE	IEC 60598-2-17 (IEC 60598-1)
EU safety	EN 60598-2-17 (EN 60598-1), EN 62471, EN62493
EU EMC	EN 55015, EN 55032, EN 55035, EN 61000-3-2, EN 61000-3-3, EN 61547
US safety	UL 1573
US EMC	FCC Part 15 Class B
Canadian safety	CSA C22.2 No. 166
Canadian EMC	ICES-3 (B) / NMB-3 (B); ICES-5 (B) / NMB-5 (B)
Australia/NZ	RCM

Included Items

Two omega brackets with 1/4 turn fasteners for rigging clamp attachment 2 x P/N 91602001

Accessories

Conversion kits

ERA 600 Framing Module (converts ERA 600 Profile to Performance). P/N 5125849-00
ERA 600 Gobo Wheel 3 Effects Module (converts ERA 600 Performance to Profile). . . . P/N 5131771-00

Optical accessories

CRI Boost Filter (CRI >80, installs on gobo wheel) MAR-91614058

Power input cables

Power Input Cable, H07RN-F, 2.5 mm², 14 AWG, bare ends to
TRUE1 NAC3FX-W (female), 1.5 m (4.9 ft.) P/N 91611797
Power Input Cable, H07RN-F, 2.5 mm², 14 AWG, bare ends to
TRUE1 NAC3FX-W (female), 5 m (16.4 ft.) P/N 91611786
Power Input Cable, SJOOW, 12 AWG, bare ends to
TRUE1 NAC3FX-W (female), 1.5 m (4.9 ft.) P/N 91610173
Power Input Cable, SJOOW, 12 AWG, bare ends to
TRUE1 NAC3FX-W (female), 5 m (16.4 ft.) P/N 91610174

Power relay cables, 16 A

Power Relay Cable, H07RN-F, 2.5 mm², TRUE1 to TRUE1, 0.45 m (1.5 ft.) P/N 91611784
Power Relay Cable, H07RN-F, 2.5 mm², TRUE1 to TRUE1, 1.2 m (3.9 ft.) P/N 91611785
Power Relay Cable, H07RN-F, 2.5 mm², TRUE1 to TRUE1, 2.5 m (8.2 ft.) P/N 91611796
Power Relay Cable, SJOOW, 12 AWG, TRUE1 to TRUE1, 0.45 m (1.5 ft.) P/N 91610170
Power Relay Cable, SJOOW, 12 AWG, TRUE1 to TRUE1, 1.2 m (3.9 ft.) P/N 91610171
Power Relay Cable, SJOOW, 12 AWG, TRUE1 to TRUE1, 2.5 m (8.2 ft.) P/N 91610172

Power connectors

Cable Connector, Neutrik powerCON TRUE1 NAC3FX-W TOP (female) P/N 91611789HU
Cable Connector, Neutrik powerCON TRUE1 NAC3MX-W TOP (male) P/N 91611788HU

Installation hardware

Half-coupler Clamp P/N 91602005
Safety Cable, SWL 60 kg, BGV C1 / DGUV 17, black P/N 91604006
Safety Cable, SWL 60 kg, BGV C1 / DGUV 17, silver P/N 91604007

Related Items

Martin® Companion software suite (incl. firmware uploader) Free download from www.martin.com
Martin® Companion Cable USB/DMX hardware interface P/N 91616091
Martin® RDM 5.5 Splitter P/N 90758150

Ordering Information

ERA 600 Performance in cardboard box P/N 9025122049
ERA 600 Performance (White) in cardboard box P/N 9025122050
ERA 600 Profile in cardboard box P/N 9025123579
ERA 600 Profile (White) in cardboard box P/N 9025123580
Flightcase, two unit, for 2 x ERA 600 Performance / Profile P/N 91512205

Specifications subject to change without notice. For the latest product specifications, including photometric data, see www.martin.com

Photobiological Safety Warning

The label shown on the right is displayed on this product. If it becomes difficult or impossible to read, it must be replaced using the illustration on the right to reproduce a new label printed in black on a yellow background.

FCC Compliance

This equipment has been tested and found to comply with the limits for a Class B digital device, pursuant to part 15 of the FCC Rules. These limits are designed to provide reasonable protection against harmful interference when the equipment is operated in a commercial environment. This equipment generates, uses and can radiate radio frequency energy and, if not installed and used in accordance with the instructions, may cause harmful interference to radio communications. Operation of this equipment in a residential area is likely to cause harmful interference, in which case the user will be required to correct the interference at his own expense.

Supplier's Declaration of Conformity

Harman Professional, Inc. have issued an FCC Supplier's Declaration of Conformity for this product. The Declaration of Conformity is available for download from the ERA 600 Performance / Profile area of the Martin website at www.martin.com

Canadian Interference-Causing Equipment Regulations - *Règlement sur le Matériel Brouilleur du Canada*

This Class B digital apparatus meets all requirements of the Canadian Interference-Causing Equipment Regulations. *Cet appareil numérique de la classe B respecte toutes les exigences du Règlement sur le Matériel Brouilleur du Canada.*

CAN ICES-3 (B) / NMB-3 (B); CAN ICES-5 (B) / NMB-5 (B)

EU Declaration of Conformity

An EU Declaration of Conformity covering this product is available for download from the ERA 600 Performance / Profile area of the Martin website at www.martin.com.

Intellectual Property Rights

Martin® ERA 600 products are covered by one or more of these patents:

CN101430080; CN102713425; CNZL200810128720.0; CNZL200810128776.6; CNZL200810144668.8; CNZL201080025103.3; CNZL201180014884.0; CNZL201380004370.6; CZ17567; EP2058586; EP2113714; EP2117284; EP2136136; EP2326150; EP2443381; EP2536974; EP2550686; EP2828577; EP2881650; US6971770; US7,703,948; US7,789,543; US7,905,630; US7,942,535; US7,990,673; US7222997; US7498756; US8,449,141; US8,708,535; US8,770,762; US9217551; US9217559;

and/or one or more of these patent applications:

CN104696882; CN104698579; CN104976548; CN105402641; CN201410740291.8; CN201410742572; DKPA201700088; EP17167067.2; EP2091302; EP2881651; EP2881652; EP2881653; EP2927579; EP2995852; US2015/0285483; US20150159827; US20150159828; US20150159830; US20160069540; US20160102850;

and/or one or more other intellectual property rights, including one or more intellectual property rights listed on www.martin.com/ipr

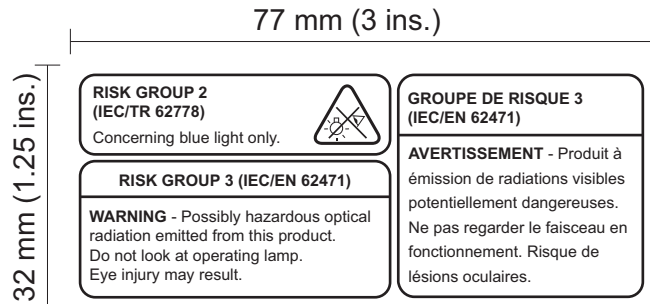

Disposing of this product

Martin products are supplied in compliance with Directive 2012/19/EC of the European Parliament and of the Council of the European Union on WEEE (Waste Electrical and Electronic Equipment), where applicable.

Help preserve the environment! Ensure that this product is recycled at the end of its life. Your supplier can give details of local arrangements for the disposal of Martin products.

The ERA 600 Profile (and any ERA 600 Performance fixture that has been updated to battery-powered control panel operation) both contain a lithium battery. Ensure that the battery is disposed of correctly and responsibly by an authorized recycling or waste disposal center at the end of its life. Where applicable, Martin participates in schemes whose aim is to ensure that local recycling and/or waste disposal centers accept batteries from Martin products.

