

PX703

Touch Panel 10"

User manual



Table of Contents

1 Description.....	4
2 Safety conditions.....	5
3 Connectors and control elements.....	6
4 Start of operation.....	7
5 Device menu.....	9
5.1 Time.....	10
5.2 Network.....	12
5.3 Display.....	14
5.4 Configurations.....	15
5.5 Info.....	20
5.6 Administration.....	21
5.6.1 <i>Change password</i>	22
5.6.2 <i>Restore to default settings</i>	23
5.6.3 <i>Restart device</i>	24
5.6.4 <i>Remove all configurations</i>	25
5.6.5 <i>Advanced tools</i>	26
6 Structure of the application window.....	27
7 Configuration.....	28
7.1 Scene.....	29
7.2 Program.....	29
7.3 Status.....	30
7.4 Events.....	30
8 Recovery button.....	31
9 Firmware update from USB.....	32
10 WWW interface.....	32
11 Montage.....	35
12 Connection scheme.....	40
13 Dimensions.....	42
14 Technical data.....	43

Manufacturer reserves the right to make modifications in order to improve device operation.

PXM Marek Żupnik sp.k.

Podłęże 654

32-003 Podłęże

BDO register number 000005972

tel. +48 12 385 83 06

mail: info@pxm.pl

www.pxm.pl

Rev.1-0

12.05.2022

1 Description

A PX703 Touch Panel 10" has been created for communication with the PX340 / PX340+ and PX710 / PX710+. From the level of touch panel you can manage configurations that were previously uploaded to the controller.

From the device you can:

- turn on and off scenes and programs
- trigger events
- display statuses
- modify master value

To be able to communicate with the controller directly from the touch panel, it is necessary to create user accounts with appropriate access rights and the appropriate controller configuration via the PxDesigner application (description of creating the configuration was placed in the PxDesigner manual available on the manufacturer's website).

Touch Panel 10" can be powered by 12 – 24V DC voltage, in addition it has the ability to power PoE (Power over Ethernet) in IEEE 802.3af standard, which allows you to power the device via twisted pair without using an external power supply while transferring data.

The PX703 is equipped with a 10.1" TFT touch screen with a resolution of 1280 x 800px.

The device has a plastic and aluminum housing, has been designed for flush mounting (wall installation).

2 Safety conditions

PX703 Touch Panel 10" is a device powered with safe voltage 12 – 24V DC or with the use of PoE (Power over Ethernet) in IEEE 802.3af standard, however, during its installation and use it is essential to follow the below safety rules:

1. The device may only be connected to 12 – 24V DC or PoE in IEEE 802.3af standard with current-carrying capacity compatible with technical data.
2. All the conductors should be protected against mechanical and thermal damage.
3. In the event of damaging any conductor, it should be replaced with a conductor of the same technical data and attestation.
4. All repairs and connections of outputs can only be made with cut off power supply.
5. PX703 should be strictly protected against contact with water and other liquids.
6. All sudden shocks, particularly dropping, should be avoided.
7. The device cannot be turned on in places with humidity exceeding 90%.
8. The device cannot be used in places with temperature lower than +2°C or higher than +40°C.
9. Clean with damp duster only.

3 Connectors and control elements

Back of the device:

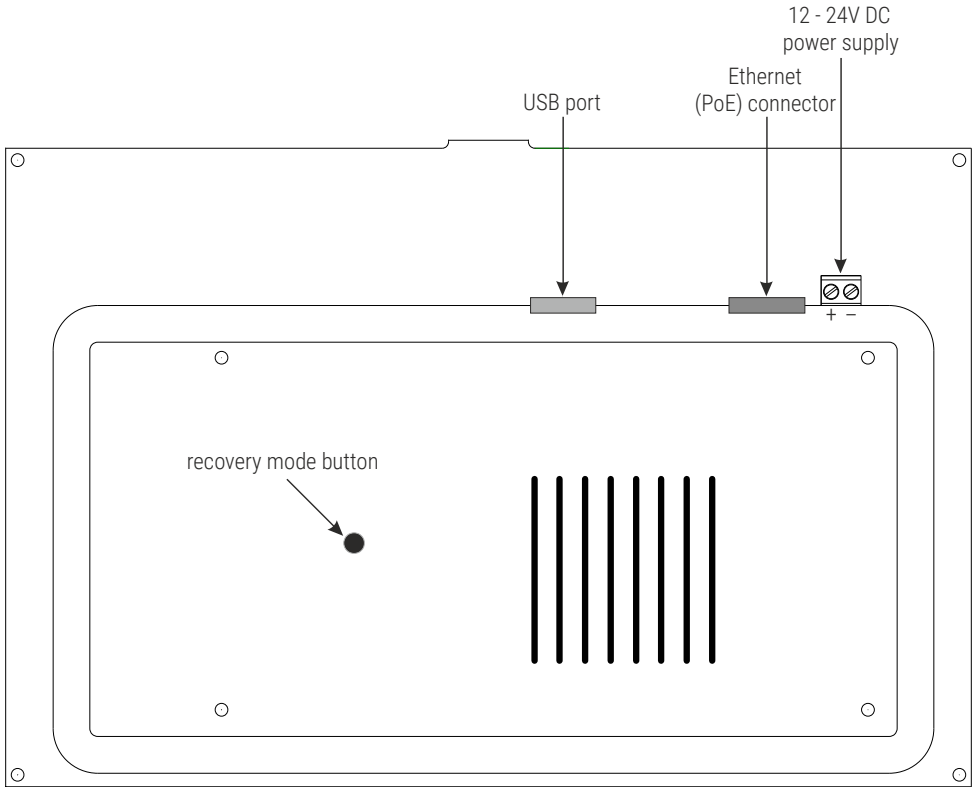

4 Start of operation

After starting, the panel displays the start page with a list of available devices:

list of available controllers in the network with which the user can connect, the device name is displayed

refresh the list of available devices

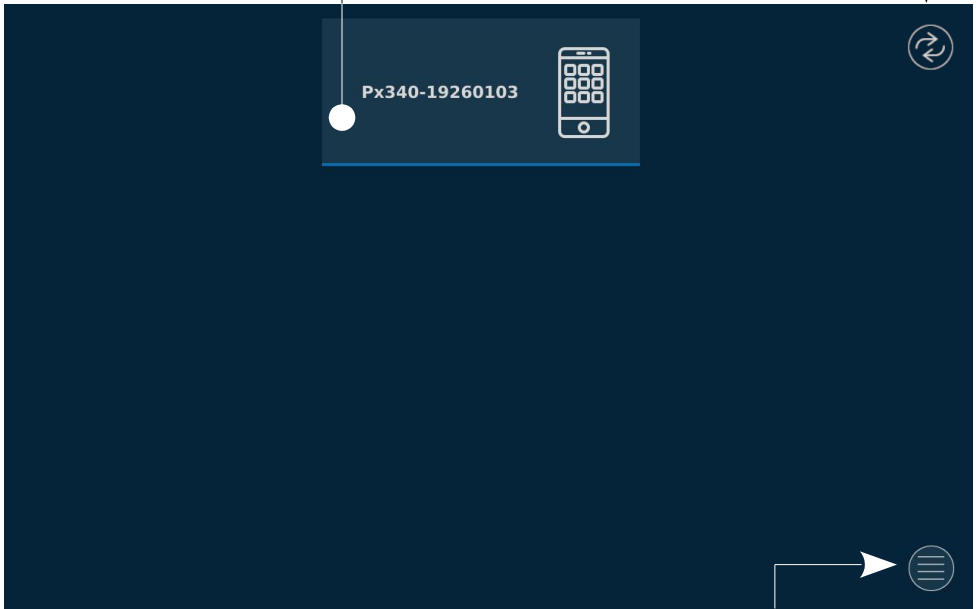

button that opens the menu with the device settings

NOTE! To make available devices appear in the start page, they must first be added to the *Configurations* menu (see section 5.4 Configurations).

The colors on the device tiles in the list of available devices determinate the connection status:

- **blue** – the user is logged in to the controller and the configuration has been downloaded from the controller to the PX703 – you can open the configuration and control it
- **yellow** – the device is in the network and the connection has been established, but the wrong username or password is entered in the *Configurations* menu
- **red** – a connection has been established with the device, but it was interrupted. To reconnect to the device, wait ~10 seconds until the list of drivers available on the network is refreshed.



5 Device menu

After entering the menu, a window containing the following tiles will appear:

clock settings

network settings

display settings



configuration management (drivers)

device and manufacturer information

administration tools

return to the main window

5.1 Time

To change the date and time, enter *Time settings*, in addition in this menu you can configure the NTP server and select the time zone. The *Time settings* window looks like this:

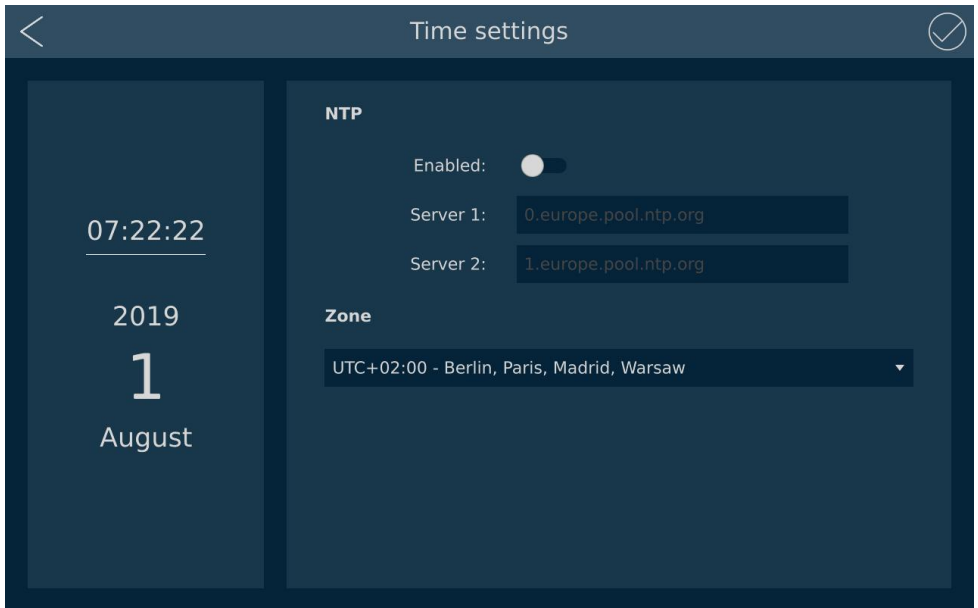

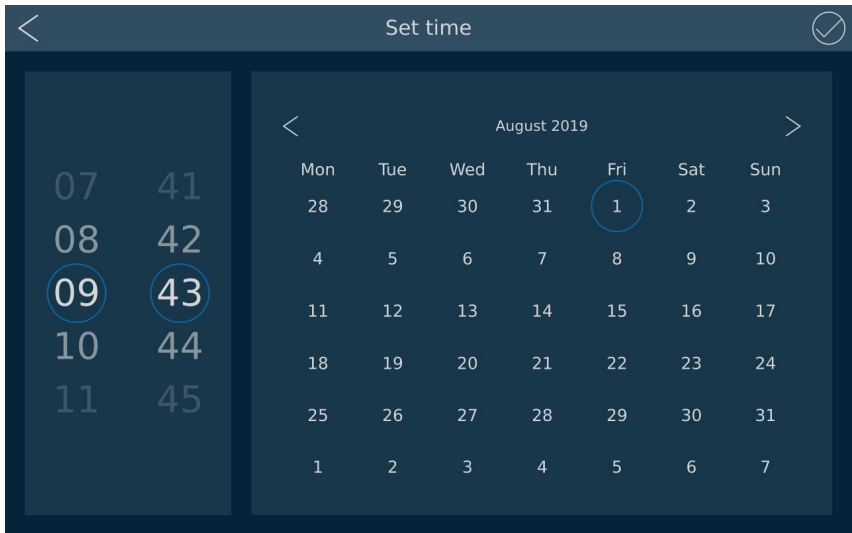

To change the date and time, click on left side of the *Time settings* window. A new window will appear in which you can change the time (by moving the roller up or down) and the date by selecting the appropriate one from the calendar.

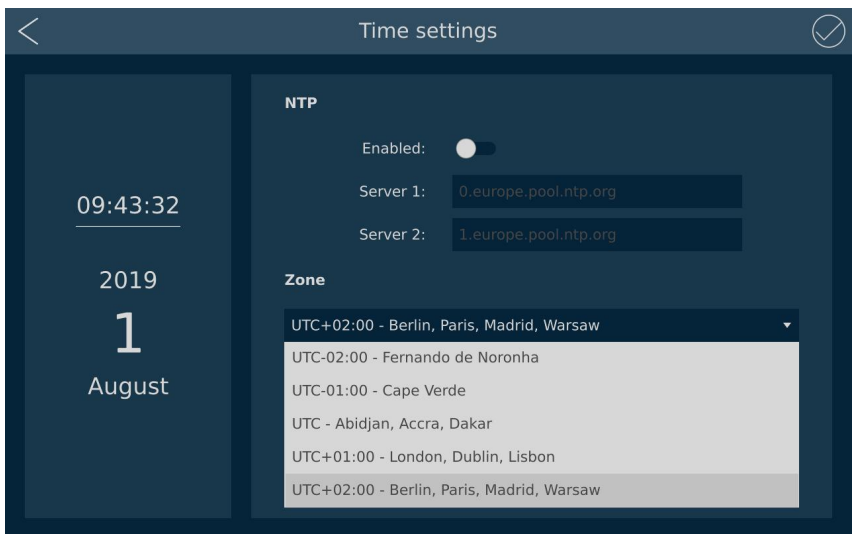

In the *Time settings* window you can enable the NTP server and specify two servers from which the Touch Panel 10" will obtain the date and time (PX703 must be connected to the internet). NTP servers can be found at: <https://www.ntppool.org/>. Below the NTP setting is the zone selection.





NOTE! When making any changes to the settings, save them by clicking the button  in the upper right corner of the screen, you can also exit without saving them by selecting the button  in the upper left corner of the screen.

5.2 Network

After selecting the network settings, a window will appear in which you can enter the network settings manually or enable automatic addressing (DHCP).

If the connection is active, the **green** circle indicating the connection status lights up with the *Ethernet* inscription. **Red** circle indicates a connection problem, such as an unconnected Ethernet cable.

NOTE! When making any changes to the settings, save them by clicking the button  in the upper right corner of the screen, you can also exit without saving them by selecting the button  in the upper left corner of the screen.

a) DHCP enabled – all networks settings are downloaded automatically

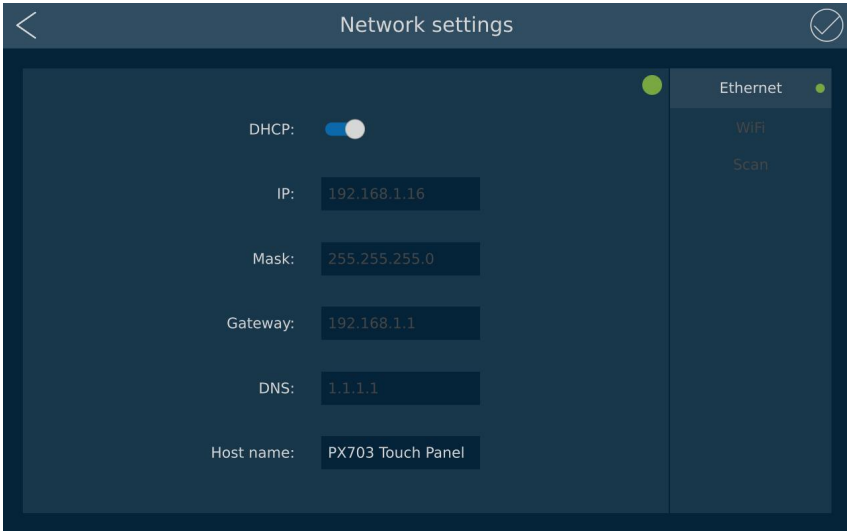

b) DHCP off – network settings are set manually

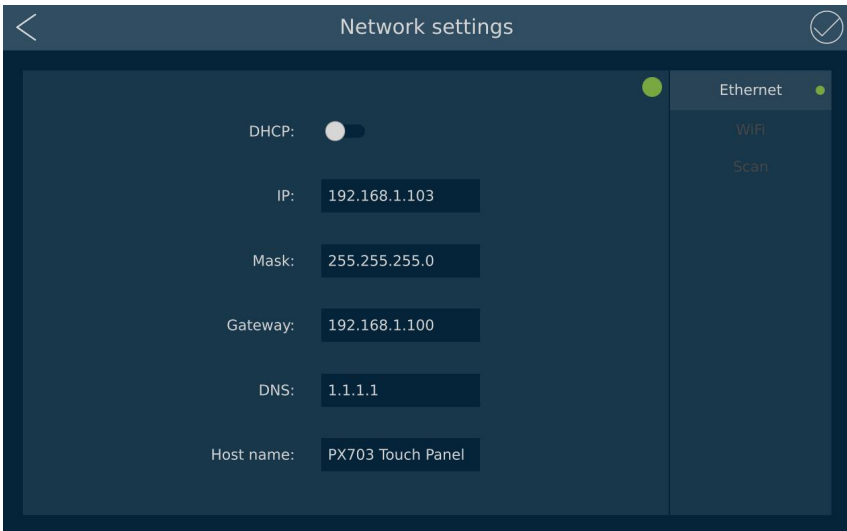

NOTE! Please note that PX703 must be on the same network as the drivers to be connected to.

5.3 Display

The *Display* tile is responsible for changing the screen brightness, screen saver settings (on / off, brightness to be set and the time after which the brightness change will be introduced). This menu is also responsible for changing the interface language (Polish / English).

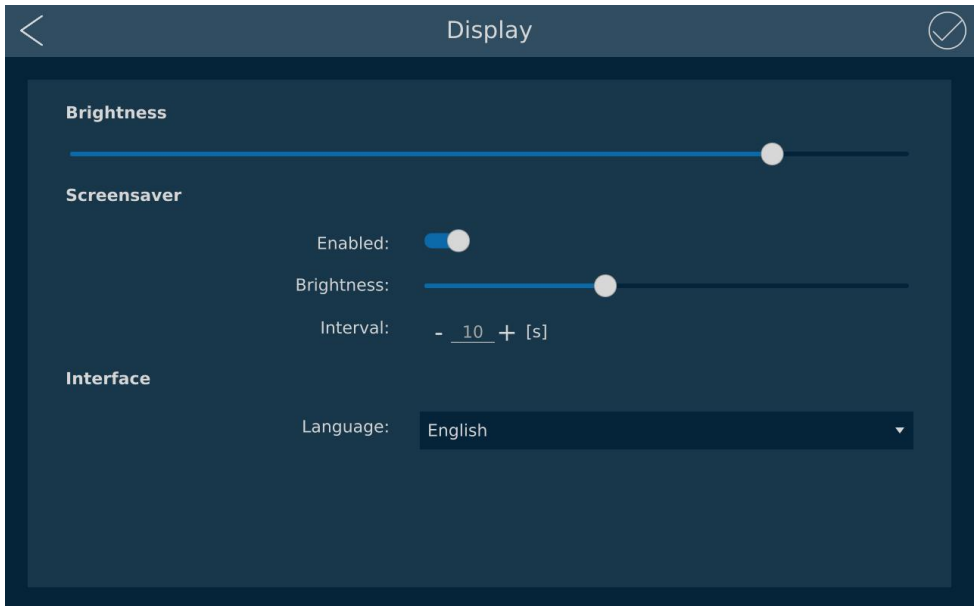

NOTE! When making any changes to the settings, save them by clicking the button ✓ in the upper right corner of the screen, you can also exit without saving them by selecting the button < in the upper left corner of the screen.

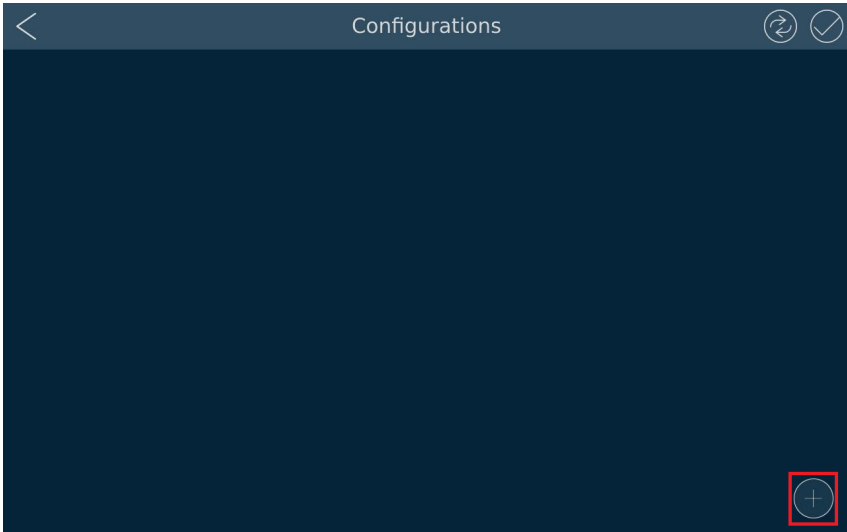

5.4 Configurations

To add a configuration (controller), go to the *Configurations* tile, and then select the button $+$ in the bottom right corner of the screen.

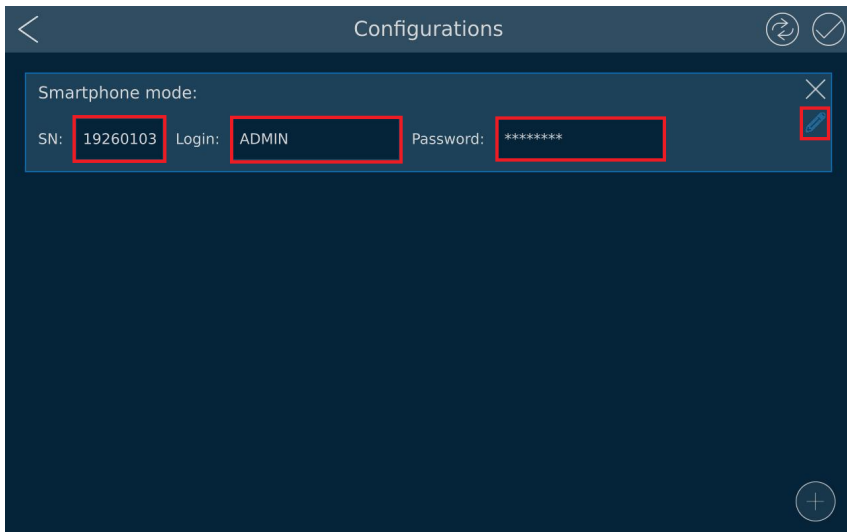

To edit the configuration (controller), press the button , after selecting it the *SN*, *Login* and *Password* fields will be activated and they will be editable. Enter the device *SN* (serial number), *Login* and *Password* of the user to be connected to the controller.



After entering the login data for the controller, press the edit button  again (to deactivate the option of editing the fields) then press the save changes button  in the upper right corner of the screen.

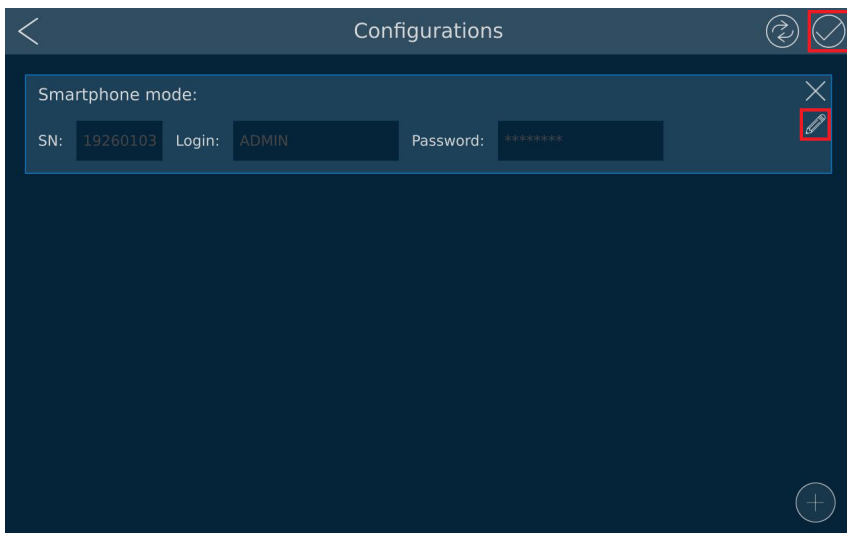

To establish connection with the controller, select the *Refresh* (↻) button, if the serial number and user data (login and password) are correct, in the upper right corner of the configuration edition a green inscription *connected* appears. In case PX703 cannot connect to the controller, a red *not found* message will appear.

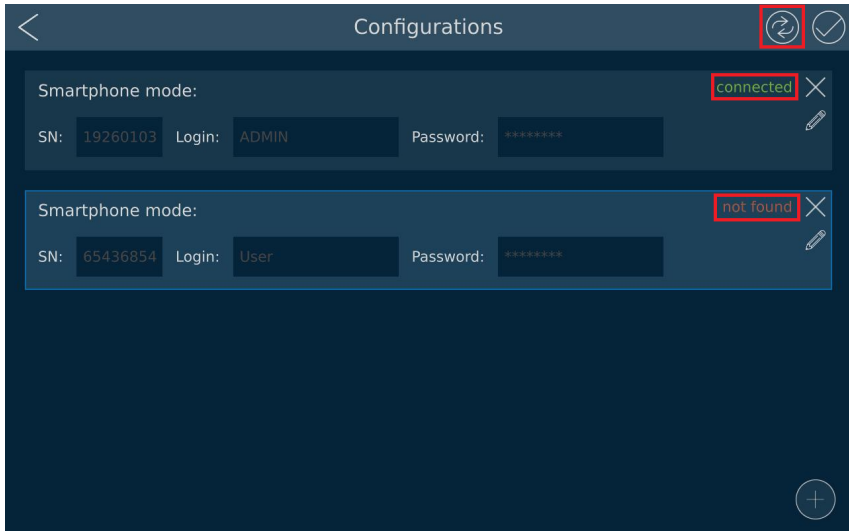

To delete a configuration, press the button **X** on the right in the configuration window that the user wants to delete.

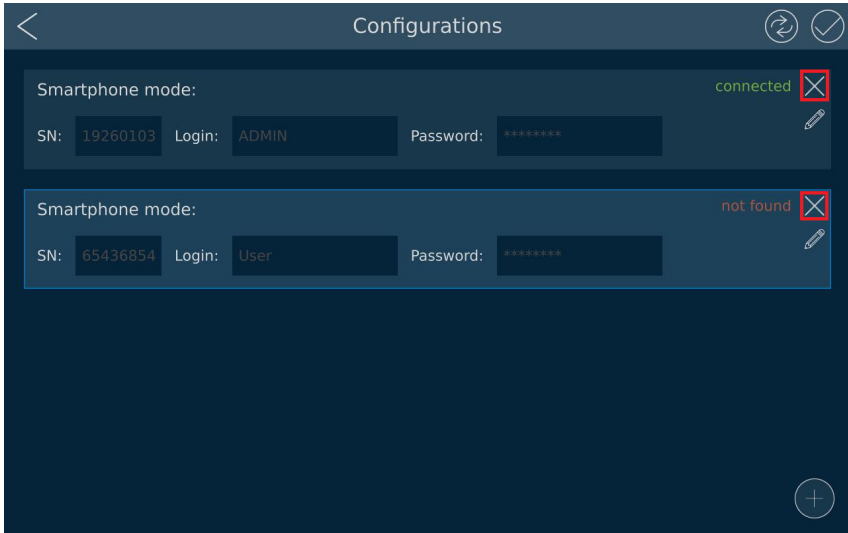

You can also delete all configurations by selecting the *Administration* tile and then *Remove all configurations* (see section 5.6 Administration).

NOTE! Only the configuration with the *connected* status is visible on the main screen.

The configuration, which is marked with a blue border, is treated as the default one and is started after switching on the device, provided the controller is available.

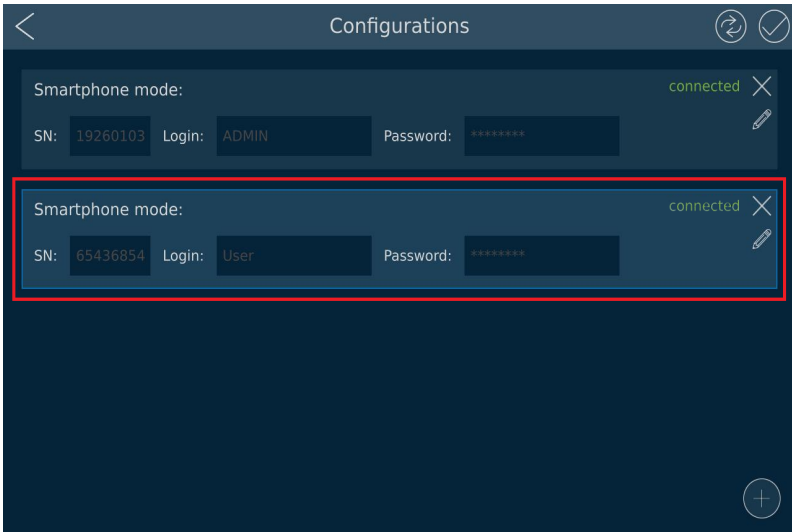

NOTE! To change the default configuration, press it to highlight it – save your selection with the button .

5.5 Info

After clicking the *Info* tile a window will appear containing:

- Device – device name
- Serial number
- Software version
- System version
- Uptime

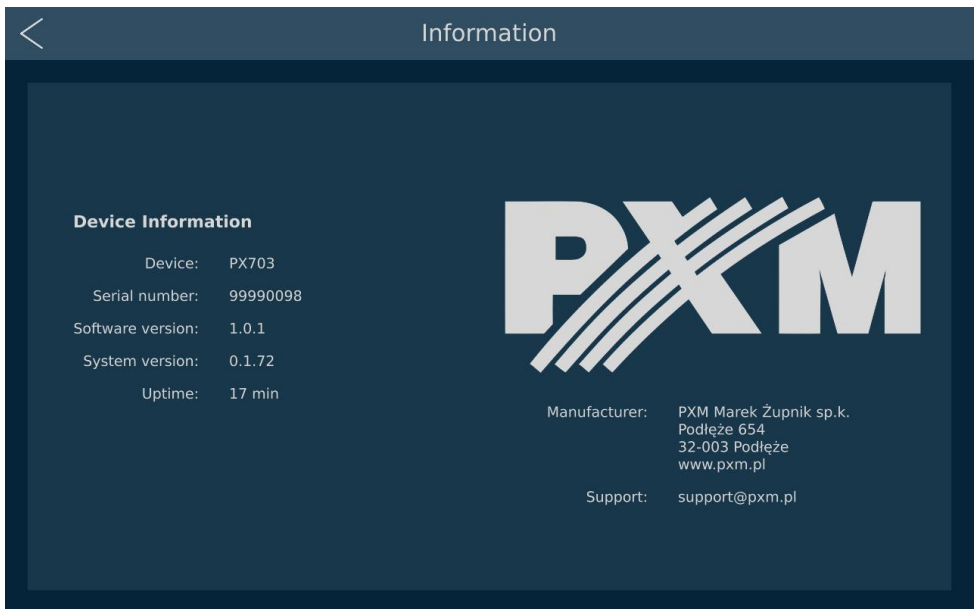

- Manufacturer information

5.6 Administration

The Administration tab looks like this:

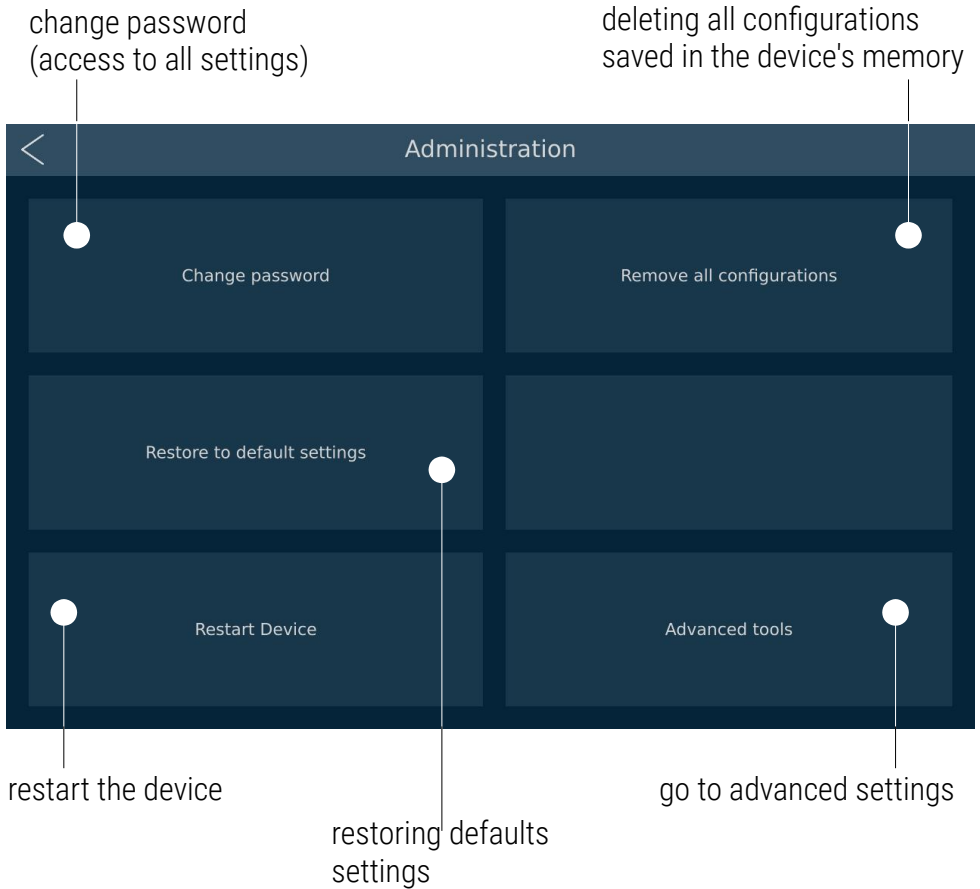

5.6.1 Change password

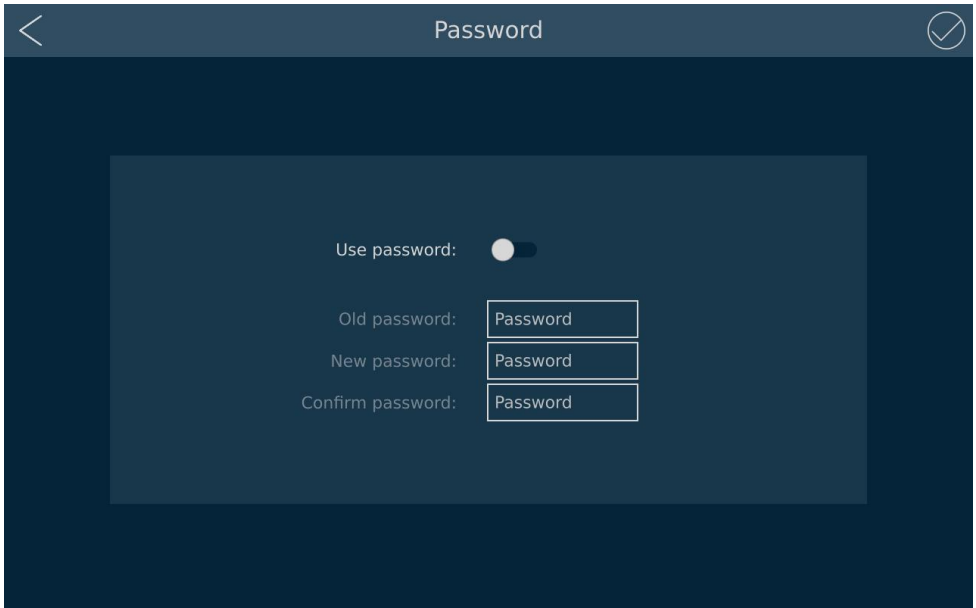

It allows you to create or change an existing password to edit settings in PX703.



To protect the settings with a password, slide the switch *Use password*, enter the default password (“*admin*”) and a new password twice.

To disable password protection, simply turn off the *Use password* option (the password will not be removed, only the option protecting the settings will be disabled).

The password is changed after entering the password used so far and entering the new password twice.

NOTE! When making any changes to the settings, save them by clicking the button  in the upper right corner of the screen, you can also exit without saving them by selecting the button  in the upper left corner of the screen.

5.6.2 *Restore to default settings*

Resets the device to default settings (the device displays the message *"Are you sure you want to restore to defaults settings?"*)

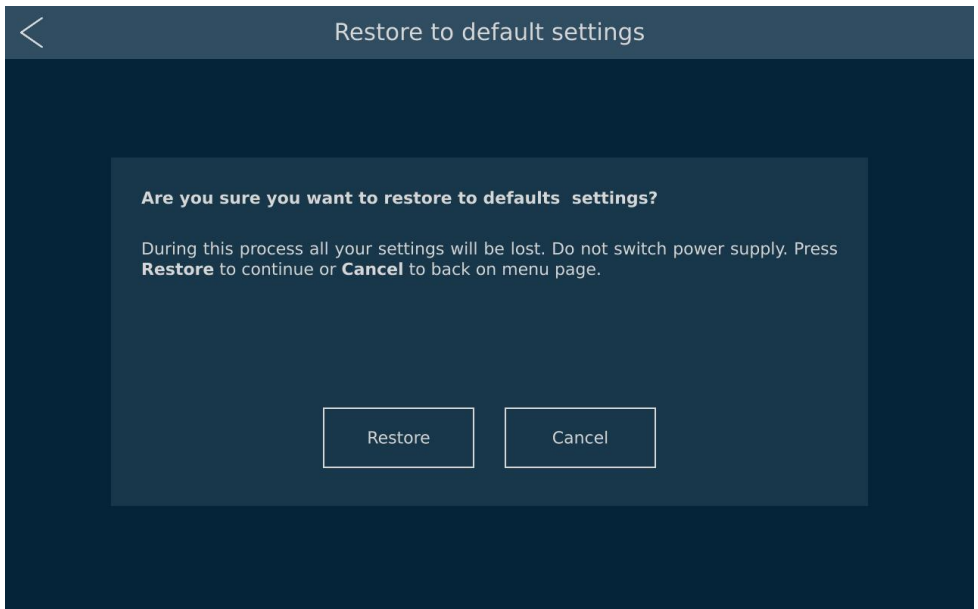

5.6.3 Restart device

Restarts the device (the device displays the message "Are you sure?")

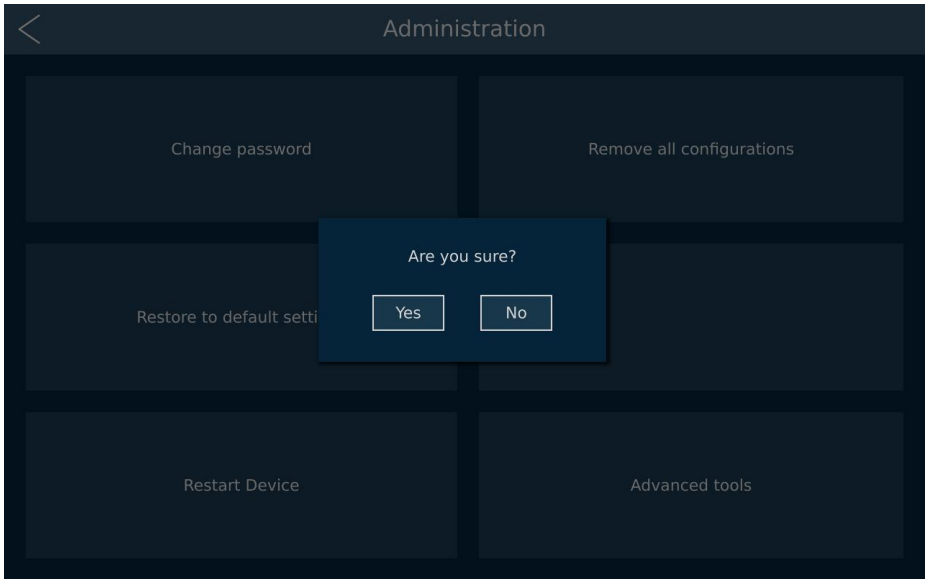

5.6.4 Remove all configurations

Deletes all configurations saved in the device's memory (the device displays the message "Are you sure you want to remove all configs?")

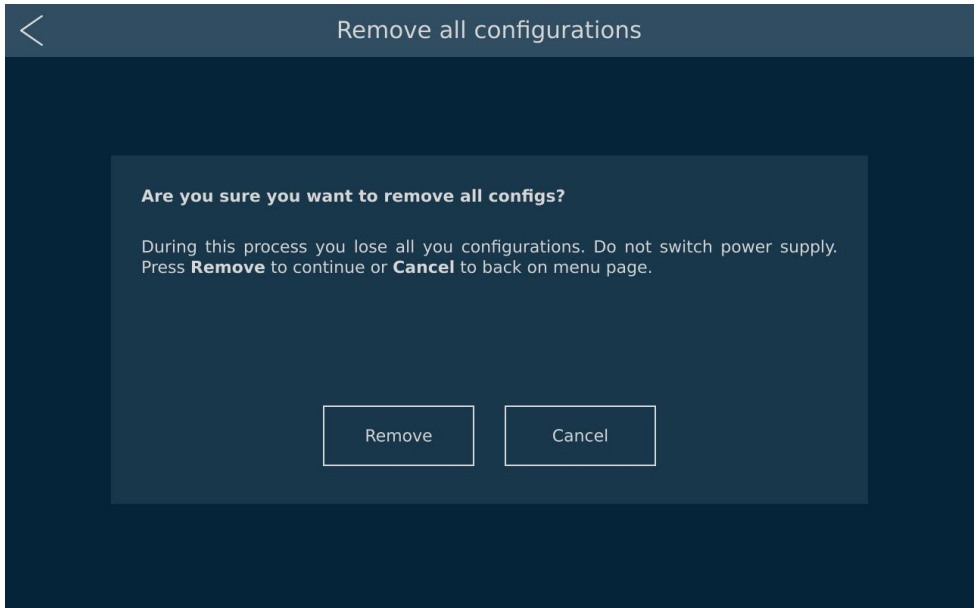

5.6.5 Advanced tools

Goes to the next menu (the device displays message "Are you sure?").

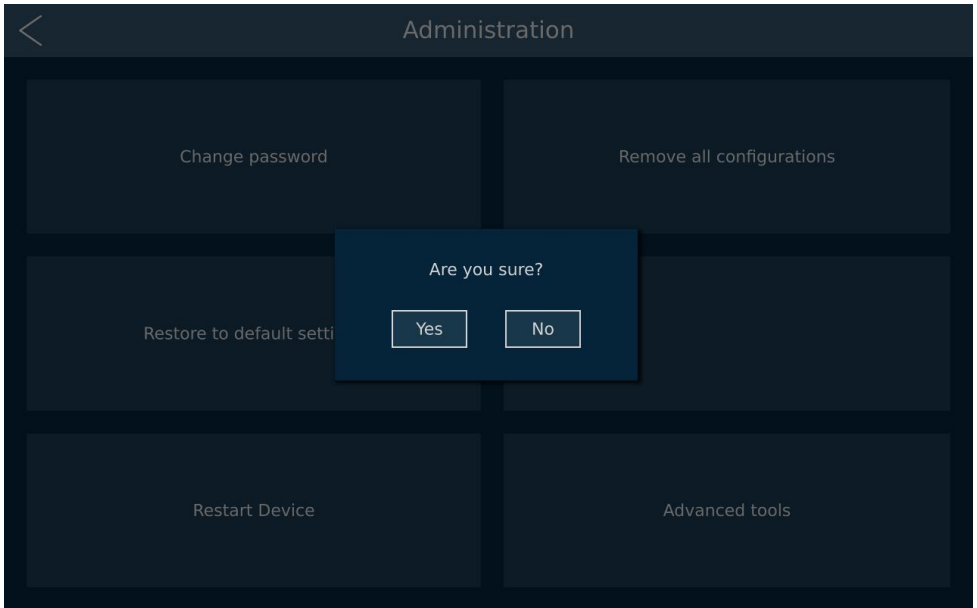

The following options are available in the *Advanced tools* menu:

- ***Change version*** – selection of the software version to be used
- ***Factory Defaults*** – full factory reset including the whole application reset
- ***Reboot device*** – restarting the device
- ***Back to application*** – return to the main window

6 Structure of the application window

After selecting the driver from the main panel window, the control screen opens. The application window consists of the following items:

controlling the scene master

speed control

zone master

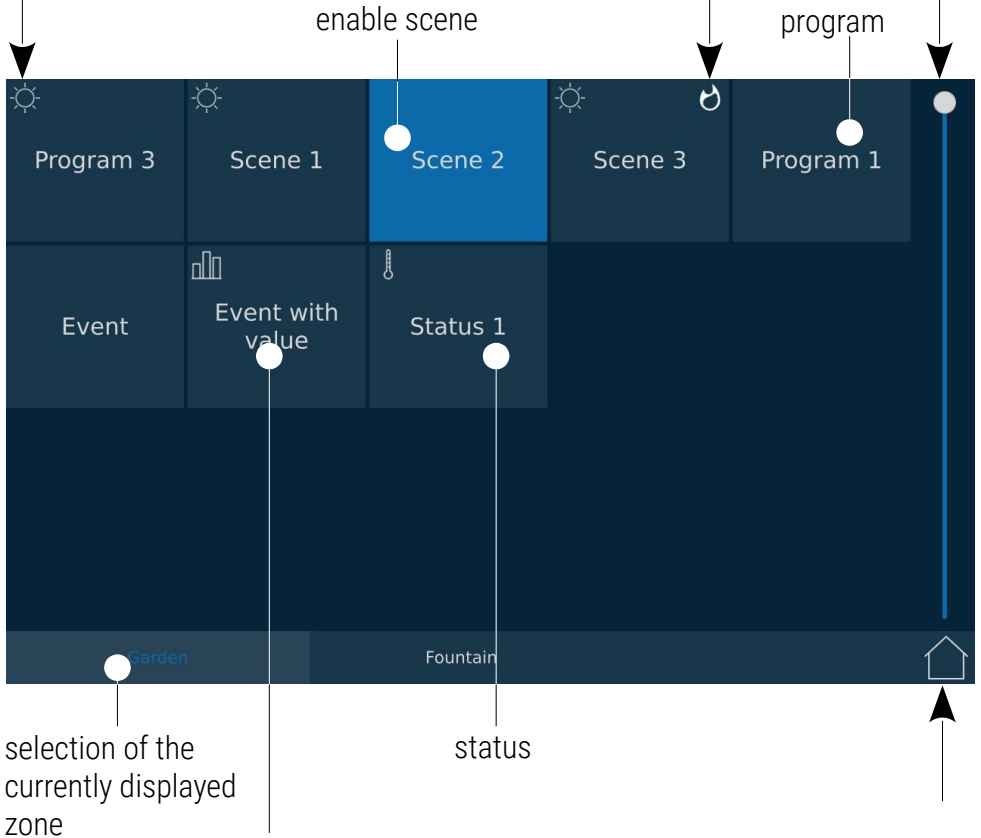

NOTE! The tile order can be edited in the smartphone application.

7 Configuration

Configuration sent to the device consists of zones (displayed in PX703 as separate desktops) to which the given user has access. After selecting the controller from the main menu, Touch Panel 10" downloads the configuration for the logged in user (selected in the *Configurations* menu).

The following items are assigned to each:



- scenes
- programs
- events
- statuses

Each item is displayed as a tile. Scenes, programs and statuses have two states – enabled (blue) and disabled. Event tiles do not have a state, but they can activate the state of another object (scene, program, status, show).

The zone master slider allows for controlling the brightness of all currently enabled items in the zone (can be deactivated in the PxDesigner application). To move between zones, select a different zone at the bottom of the program window. Clicking the tile starts / deactivates the item. However, clicking the icon on the tile (⚙️ / 🔥 / 📊) changes it into a “circular” slider and gives the opportunity to change the value of the scene master, program, program speed or event value.

7.1 Scene





Scene can be masterable – you can modify its master when the symbol  is displayed in the upper left corner.

Clicking on a scene switches its state. The tile color indicates the currently state of the scene (navy blue when it is disabled and blue when it is enabled). The scene for which the master parameter can be changed is indicated by the symbol . Clicking on  changes the tile into a “circular” slider.



Exiting the scene master edit is possible after clicking the icon .

7.2 Program

For a program, you can control the master  value and speed . Clicking the program tile switches its state (on / off). The tile color indicates the currently state of the scene (navy blue when it is disabled and blue when it is enabled). Clicking the icon in the upper right or left corner will turn the tile into a “circular” slider (*Master*  or *Speed* ).

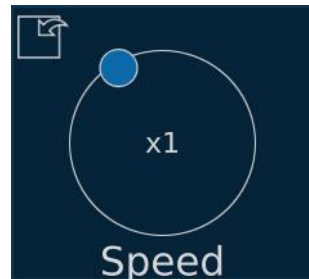
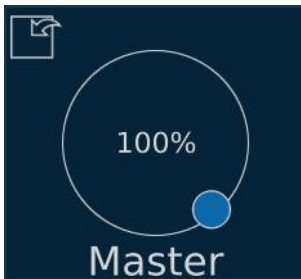

7.3 Status

Displayed as a tile that does not respond to clicking. The tile color indicates the current state of the selected status of the controller:

- navy blue, when it is disabled
- blue, when it is enabled



7.4 Events

Event with no value:

Tile which sends an appropriate event to the controller every time it is pressed on. The tile is highlighted when it is clicked.



Event with value:

Clicking the icon  displays a “circular” slider on which you can select the value to be sent to the device.

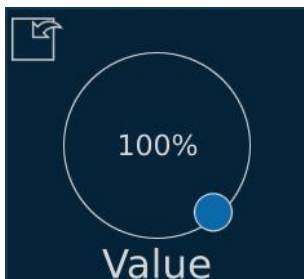

NOTE! The sent value to the device in the event of an event opposed to change of scene or program master is sent after selecting the set value with the slider and releasing it – the change is not smooth.

8 Recovery button

The device has a *Recovery* button that launch advanced device administration tools.

To turn on *Recovery* mode, hold down the button at the back in the middle of the device when starting the PX703.

After starting this mode, the *Advanced Tools* window will be launched, in *Advanced Tools* menu the available options are:

- ***Reset Password*** – reset the password (you must enter a new one)
- ***Change version*** – selection of the software version to be used
- ***Factory Defaults*** – full factory reset including the reset of the entire application
- ***Reboot device*** – restarting the device
- ***Back to application*** – return to the main window

9 Firmware update from USB

In order to update the firmware, prepare a USB stick formatted in NTFS or FAT32 and follow the steps below:

1. The *firmware.bin* file should be uploaded to a pendrive (there can be nothing more than the *firmware.bin* file)
2. Unplug the PX703 from the power supply
3. Insert the memory stick into the USB socket
4. Connect the Touch Panel to the power supply
5. The update will start automatically
6. After update is completed, a message will be display instructing you to disconnect the pendrive
7. Then the device will reboot automatically

NOTE! The *firmware.bin* file is available for download from the manufacturer's website (<http://pxm.pl/>)

10 WWW interface

PX703 can be managed from a web browser. To do this, go to `http://device_IP_address/` (e.g. 192.168.1.100), the IP address can be checked by clicking the *Network* tile on the device. When logging in to the website, enter the user and password (the user is always *ADMIN*, and the password is the same as for security settings, *admin* by default).

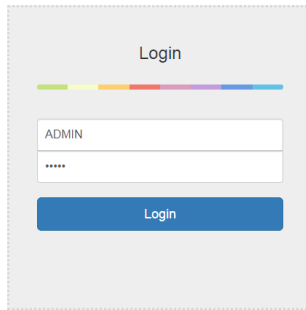

Being on the device management page, you can set exactly the same parameters as using the setting, i.e.:

- **Time and Date** – change the time, date, zone or NTP server settings

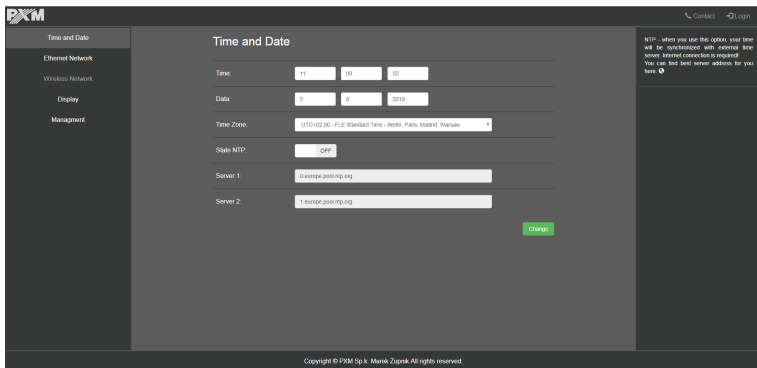

- **Ethernet Network** – network setting such as DHCP, IP, mask, gate, DNS and host name

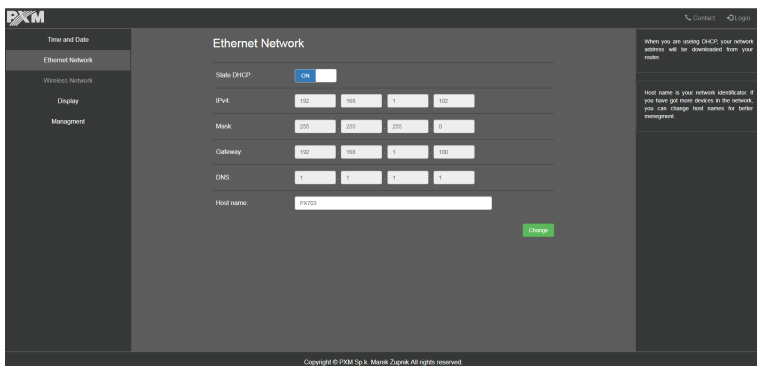

- **Display** – change of brightness, screen saver settings and language change

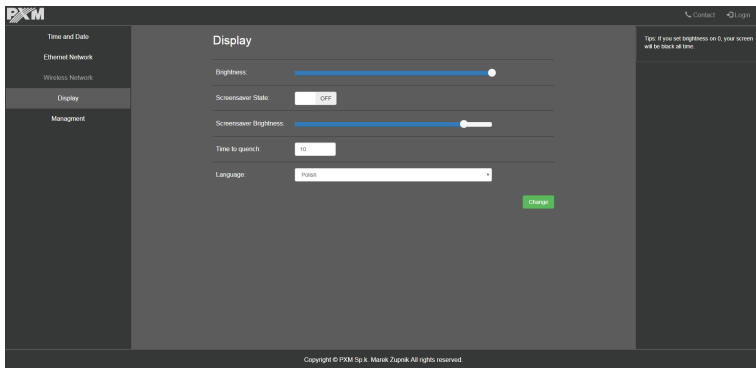

- **Management** – enable / disable and change the security password, update the software, reset settings to default, delete all configurations, search for devices and restart the device

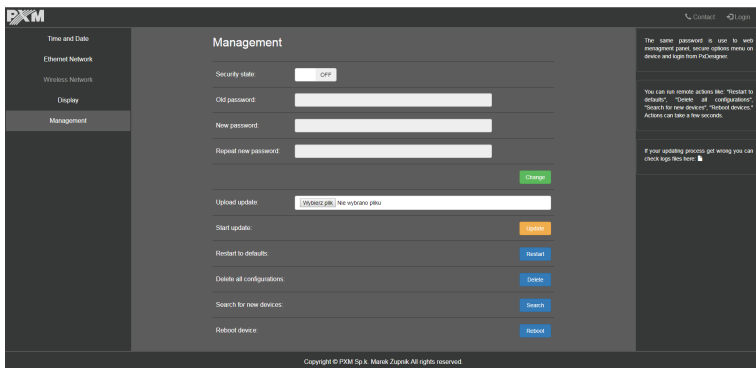

11 Montage

After mounting the box in the wall, you can proceed to install the screen.

First, connect the cabling, and then apply the PX703 to the box with its upper part, so that the tooth protruding from the screen enters the hole in the metal box.

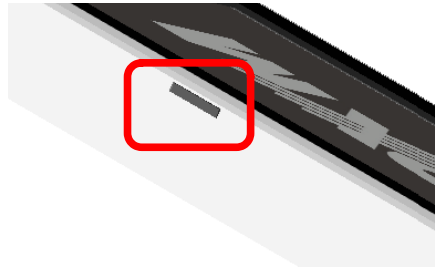

Then, paying attention to the fact that the tooth is in the hole, press the bottom of the screen towards the metal housing until you hear a characteristic click.



The screen mounded in this way is ready for use.



In order to dismantle the screen, insert the included angle into the hole under the screen and press it firmly.



When the metal angle is inserted under the screen and pressed down, swing the bottom of the screen down and pull it towards you.



12 Connection scheme

a) connecting the device to external power supply and to a router with DHCP server enabled

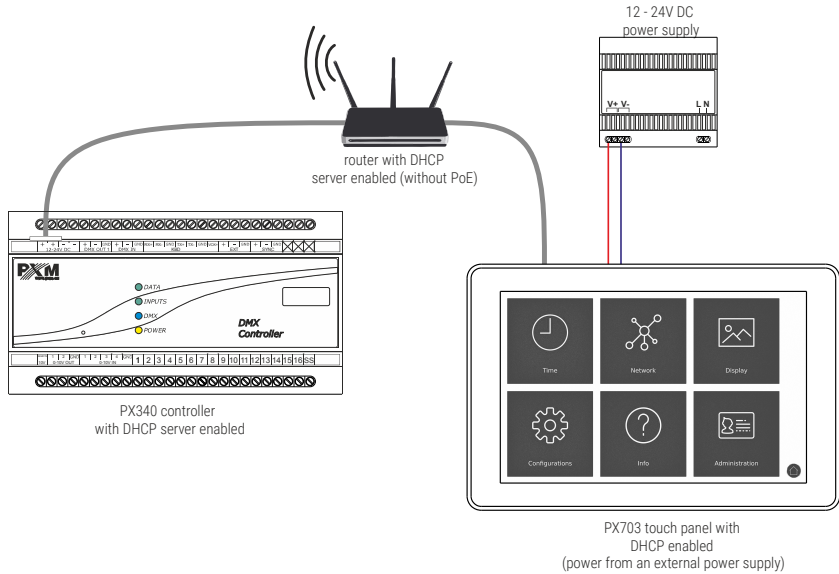

b) connecting the device to a router with the DHCP server disabled (static IP addresses) using PoE power supply in IEEE 802.3af standard

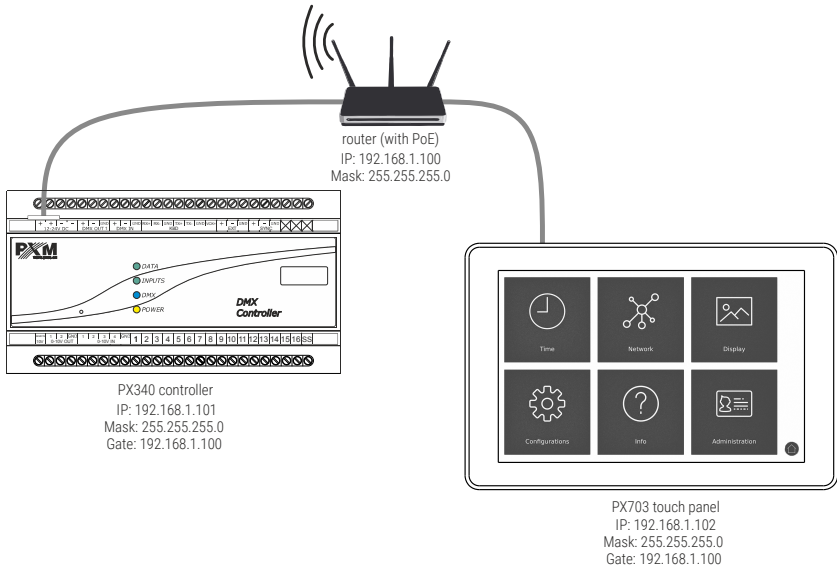

c) connecting the device directly to the controller (static IP addresses)

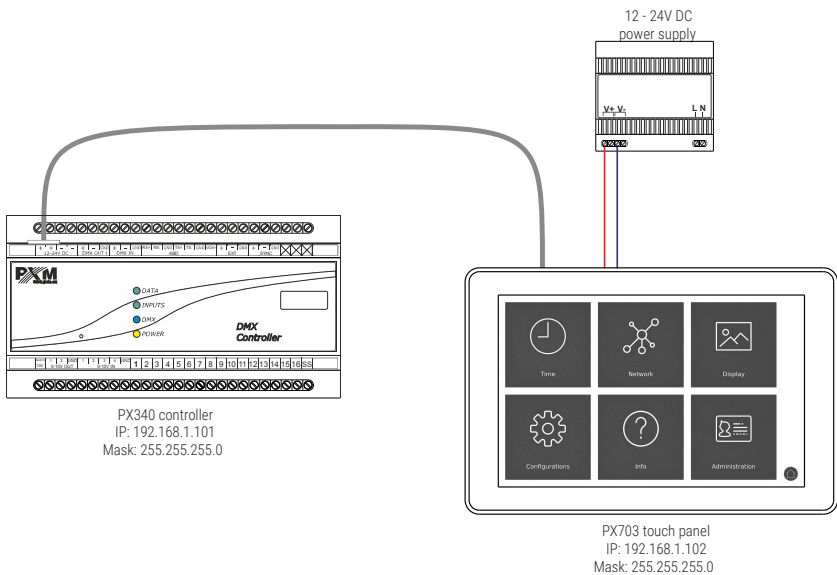

13 Dimensions

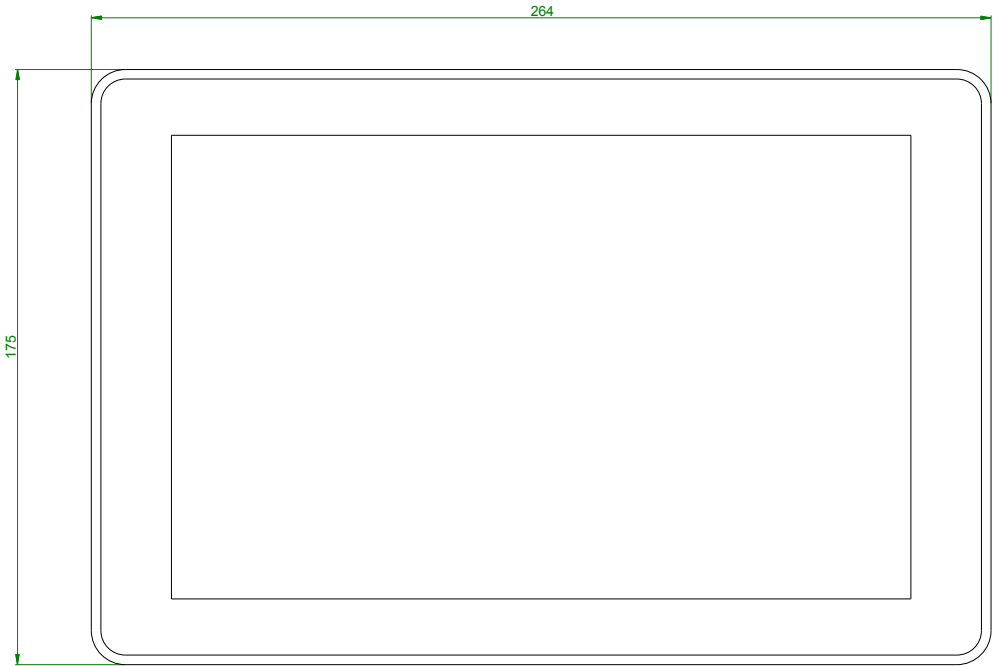
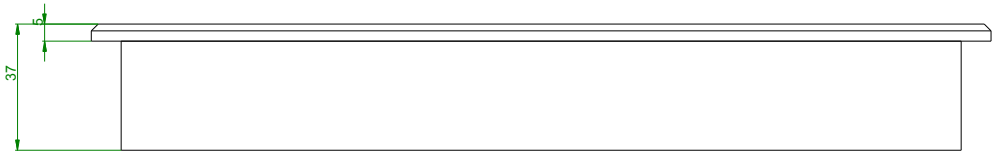

14 Technical data

type	PX703
display	TFT 10.1" 16:9
screen resolution	1280 x 800px
power supply	12 – 24VDC or PoE (Power over Ethernet IEEE 802.3af)*
housing	aluminum / plastic
connectors	1 x USB 1 x Ethernet (PoE) 1 x reset button
DHCP protocol support	yes
max. current consumption	11W
weight	1.1kg
dimensions	length: 264mm width: 175mm depth: 37mm

* - it is recommended to use only one type of power supply at a time (12 – 24V DC or PoE)

DECLARATION OF CONFORMITY

PXM Marek Żupnik spółka komandytowa
Podłęże 654, 32-003 Podłęże

we declare that our product:

Product name: Touch Panel 10"

Product code: PX703

meets the requirements of the following standards, as well as harmonised standards:

PN-EN IEC 63000:2019-01	EN IEC 63000:2018
PN-EN 61000-4-2:2011	EN 61000-4-2:2009
PN-EN IEC 61000-6-1:2019-03	EN IEC 61000-6-1:2019
PN-EN IEC 61000-6-3:2021-08	EN IEC 61000-6-3:2021

and meets the essential requirements of the following directives:

2011/65/UE **DIRECTIVE OF THE EUROPEAN PARLIAMENT AND OF THE COUNCIL** of 8 June 2011 on the restriction of the use of certain hazardous substances in electrical and electronic equipment
Text with EEA relevance.

2014/30/UE **DIRECTIVE OF THE EUROPEAN PARLIAMENT AND OF THE COUNCIL** of 26 February 2014 on the harmonisation of the laws of the Member States relating to electromagnetic compatibility (recast)
Text with EEA relevance.

Marek Żupnik spółka komandytowa
32-003 Podłęże, Podłęże 654
NIP 677-002-54-53



mgr inż. Marek Żupnik.