

Powerwerks™

PW4P OWNER'S MANUAL



Congratulations on the purchase of your Powerwerks PW4P.

This personal monitor combines quality performance and convenient features, all in a highly portable package. You'll find that the PW4P works well in a variety of environments, amplifying vocals, instruments, keyboards, drum machines, audio devices and more. This manual will help get you up and running quickly. We wish you many years of enjoyment from your Powerwerks PW4P.

IMPORTANT SAFETY INSTRUCTIONS

Danger

Exposure to extremely high noise levels may cause a permanent hearing loss. Individuals vary considerably to noise induced hearing loss but nearly everyone will lose some hearing if exposed to sufficiently intense noise for a sufficient time.

The U.S. Government's Occupational Safety and Health Administration (OSHA) has specified the following permissible noise level exposures:

DURATION PER DAY (HOURS)	8	6	4	3	2	1
SOUND LEVEL (dB)	90	93	95	97	100	103

According to OSHA, any exposure in the above permissible limits could result in some hearing loss. Earplugs or protectors in the ear canal or over the ears must be worn when operating this amplification system in order to prevent a permanent hearing loss. If exposure in excess of the limits as put forth above, to insure against potentially harmful exposure to high sound pressure levels, it is recommended that all persons exposed to equipment capable of inducing high sound pressure levels, such as this amplification system, be protected by hearing protectors while this unit is in operation.



THIS SYMBOL IS INTENDED TO ALERT THE USER TO THE PRESENCE OF NON-INSULATED "DANGEROUS VOLTAGE" WITHIN THE PRODUCT'S ENCLOSURE THAT MAY BE OF SUFFICIENT MAGNITUDE TO CONSTITUTE A RISK OF ELECTRIC SHOCK TO PERSONS.



THIS SYMBOL IS INTENDED TO ALERT THE USER TO THE PRESENCE OF IMPORTANT OPERATING AND MAINTENANCE (SERVICING) INSTRUCTIONS IN THE LITERATURE ACCOMPANYING THE UNIT.



APPARATUS SHALL NOT BE EXPOSED TO DRIPPING OR SPLASHING AND THAT NO OBJECTS FILLED WITH LIQUIDS, SUCH AS VASES, SHALL BE PLACED ON THE APPARATUS.

1. Read all safety and operating instructions before using this product.
2. All safety and operating instructions should be kept for future reference.
3. Read and understand all warnings listed on the operating instructions.
4. Follow all operating instructions to operate this product.
5. This product should not be used near water, i.e. Bathtub, sink, swimming pool, wet basement, etc.
6. Only use dry cloth to clean this product.
7. Do not block any ventilation openings, It should not be placed flat against a wall or placed in a built-in enclosure that will impede the flow of cooling air.
8. Do not install this product near any heat sources; such as, radiators, heat registers, stove or other apparatus (including heat producing amplifiers) that produce heat.
9. Do not defeat the safety purpose of the polarized or grounding-type plug. A polarized plug has two blades with one wider than the other. A grounding-type plug has two blades and a third grounding prong. The wide blade or the third prong are provided for your safety if the provided plug does not fit into your outlet, consult an electrician for replacement of the obsolete outlet.
10. Protect the power cord being walked on or pinched, particularly at Plugs, convenience receptacles and the point where they exit from the apparatus. Do not break the ground pin of the power supply cord.
11. Only use attachments specified by the manufacturer.
12. Use only with the cart, stand, tripod, bracket, or table specified by the manufacturer or sold with the apparatus. When a cart is used, use caution when moving cart/apparatus combination to avoid injury from tip-over.
13. Unplug this apparatus during lightning storms or when unused for long periods of time.
14. Care should be taken so that objects do not fall and liquids are not spilled into the unit through the ventilation ports or any other openings.
15. Refer all servicing to qualified service personnel. Servicing is required when the apparatus has been damaged in any way; such as, power-supply cord or plug is damaged, liquid has been spilled or objects have fallen into the apparatus, the apparatus has been exposed to rain or moisture, does not operate normally or has been dropped.
16. WARNING: To reduce the risk of fire or electric shock, do not expose this apparatus to rain or moisture.
17. When the MAINS plug, or an appliance coupler is used as the disconnect device, the disconnect device shall remain readily operable.
18. Protective Ground Terminal: The apparatus shall be connected to an AC main socket with a protective earth ground connection.



IMPORTANT SAFETY INSTRUCTIONS

FRENCH

Danger

L'exposition à des niveaux élevés de bruit peut provoquer une perte permanente de l'audition. Chaque organisme humain réagit différemment quant à la perte de l'audition, mais quasiment tout le monde subit une diminution de l'acuité auditive lors d'une exposition suffisamment longue au bruit intense. Les autorités compétentes en réglementation de bruit ont défini les expositions tolérées aux niveaux de bruits:

DURATION PER DAY (HOURS)	8	6	4	3	2	1
SOUND LEVEL (dB)	90	93	95	97	100	103

Selon les autorités, toute exposition dans les limites citées ci-dessus, peuvent provoquer certaines pertes d'audition. Des bouchons ou protections dans l'appareil auditif ou sur l'oreille doivent être portés lors de l'utilisation de ce système d'amplification afin de prévenir le risque de perte permanente de l'audition. Dans le cas d'expositions supérieures aux limites précitées il est recommandé, afin de se prémunir contre les expositions aux pressions acoustiques élevées potentiellement dangereuses, aux personnes exposées aux équipements capables de délivrer de telles puissances, tels ce système d'amplification en fonctionnement, de protéger l'appareil auditif.



CE SYMBOLE A POUR BUT D'AVERTIR L'UTILISATEUR DE LA PRESENCE DE VOLTAGE DANGEREUX NON-ISOLE A L'INTERIEUR DE CE PRODUIT QUI PEUT ETRE DE PUISSANCE SUFFISAMMENT IMPORTANTE POUR PROVOQUER UN CHOC ELECTRIQUE AUX PERSONNES.



CE SYMBOLE A POUR BUT D'AVERTIR L'UTILISATEUR DE LA PRESENCE D'INSTRUCTIONS D'UTILISATION ET DE MAINTENANCE DANS LES DOCUMENTS FOURNIS AVEC CE PRODUIT.



AFIN DE REDUIRE LES RISQUÉ D'INCENDIE ET DE DECHARGE ELECTRIQUE, NE PAS EXPOSER CET APPAREIL A LA PLUIE OU A L'HUMIDITE.

1. Lire avec attention toutes les recommandations et précautions d'emploi avant d'utiliser ce produit.
2. Toutes les recommandations et précautions d'emploi doivent être conservées afin de pouvoir s'y reporter si nécessaire.
3. Lire et comprendre tous les avertissements énumérés dans les précautions d'emploi.
4. Suivre toutes les précautions d'emploi pour utiliser ce produit.
5. Ce produit ne doit pas être utilisé près d'eau, comme par exemple baignoires, éviers, piscine, sous-sol humides ... Etc.
6. Utiliser exclusivement un chiffon sec pour nettoyer ce produit.
7. Ne bloquer aucune ouverture de ventilation. Ne pas placer le produit tout contre un mur ou dans une enceinte fermée, cela générerait le flux d'air nécessaire au refroidissement.
8. Ne pas placer le produit près de toute source de chaleur telle que radiateurs, arrivées d'air chaud, fourneaux ou autres appareils générant de la chaleur (incluant les amplificateurs producteurs de chaleur).
9. Ne pas négliger la sécurité que procure un branchement polarisé ou avec raccordement à la terre. Un branchement polarisé comprend deux fiches dont l'une est plus large que l'autre. Un branchement à la terre comprend deux fiches plus une troisième reliée à la terre. Si la fiche secteur fournie ne s'insère pas dans votre prise de courant, consulter un électricien afin de remplacer votre prise obsolète.
10. Protéger le cordon d'alimentation de tout écrasement ou pincement, particulièrement au niveau des fiches, des réceptacles utilisés et à l'endroit de sortie de l'appareil. Ne pas casser la fiche de terre du cordon d'alimentation.
11. Utiliser uniquement les accessoires spécifiés par le constructeur.
12. Utiliser uniquement avec le chariot de transport, le support, le trépied, la console ou la table spécifiés par le constructeur ou vendus avec l'appareil. Lors de l'utilisation d'un chariot, bouger avec précaution l'ensemble chariot/appareil afin d'éviter les dommages d'un renversement.
13. Débrancher cet appareil lors d'orages ou s'il n'est pas utilisé pendant une longue période.
14. Des précautions doivent être prises afin qu'aucun objet ne tombe et qu'aucun liquide ne se répande à l'intérieur de l'appareil par les orifices de ventilation ou n'importe quelle autre ouverture.
15. Pour toutes interventions techniques s'adresser à un technicien qualifié. L'intervention technique est nécessaire lorsque l'appareil a été endommagé de n'importe quelle façon, comme par exemple si le cordon secteur ou sa fiche sont détériorés, si du liquide a coulé ou si des objets sont tombés à l'intérieur de l'appareil, si l'appareil a été exposé à la pluie ou à l'humidité, s'il ne fonctionne pas normalement ou s'il est tombé.
16. ATTENTION: Pour réduire le risque d'incendie ou de choc électrique ne pas exposer l'appareil à la pluie ou à l'humidité.
17. Quand La prise MAINS, au coupler, est utilisé pour la source d'alimentation électrique. Il est conseillé de garder cette prise facilement accessible.
18. Borne de terre de protection: L'appareil doit être connecté à un connecteur AC principale avec un raccordement à la terre de protection.



FCC Statements

1. Caution: Changes or modifications to this unit not expressly approved by the party responsible for compliance could void the user's authority to operate the equipment.

2. Note: This equipment has been tested and found to comply with the limits for a Class B digital device, pursuant to Part 15 of the FCC Rules. These limits are designed to provide reasonable protection against harmful interference in a residential installation. This equipment generates, uses, and can radiate radio frequency energy and, if not installed and used in accordance with the instructions, may cause harmful interference to radio communications. However, there is no guarantee that interference will not occur in a particular installation. If this equipment does cause harmful interference to radio or television reception, which can be determined by turning the equipment off and on, the user is encouraged to try to correct the interference by one or more of the following measures:

- Reorient or relocate the receiving antenna.
- Increase the separation between the equipment and receiver.
- Connect the equipment into an outlet on a circuit different from that to which the receiver is connected.
- Consult the dealer or an experienced radio/TV technician for help.

CONTROLS & FEATURES OVERVIEW:

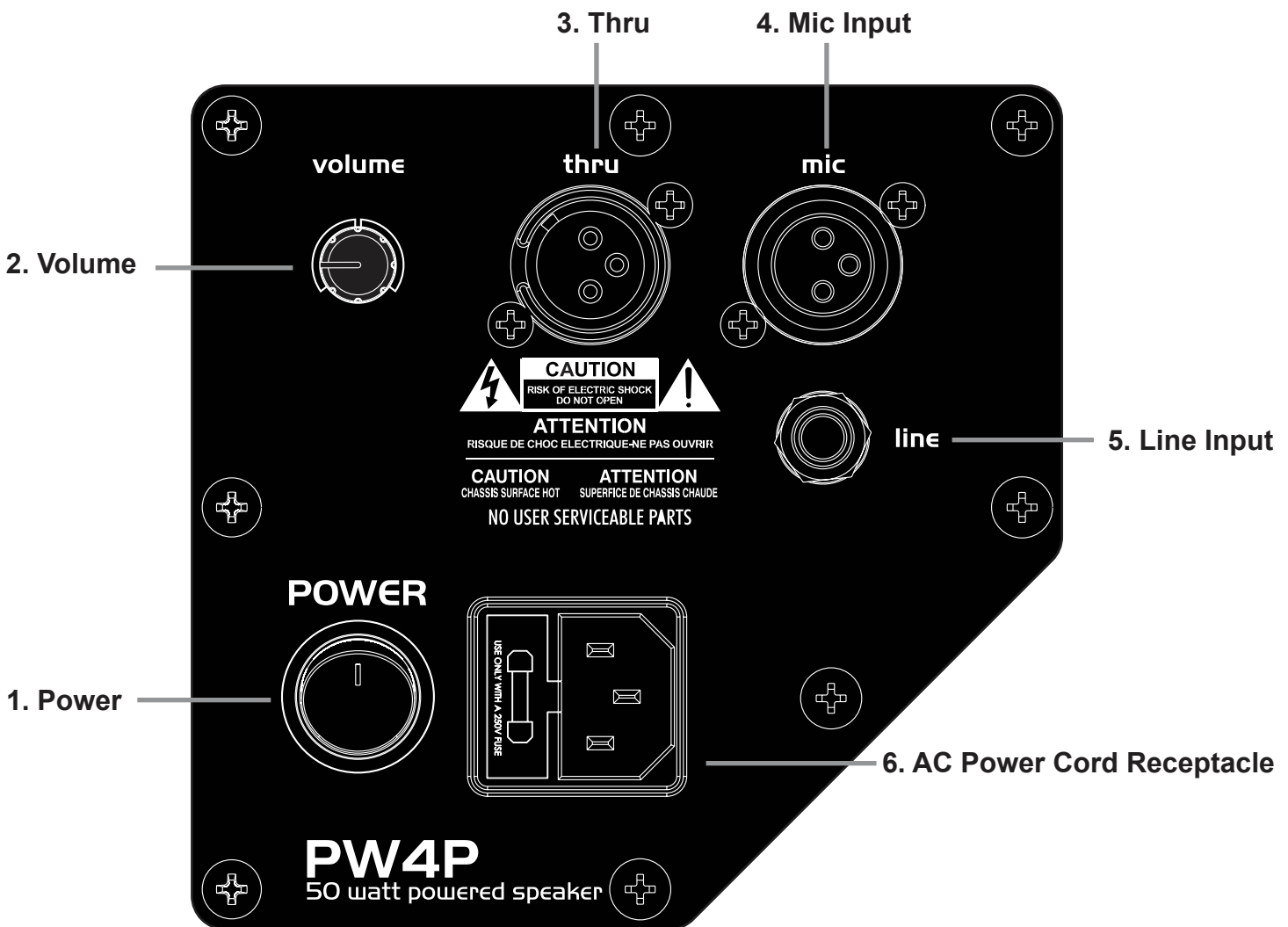

1. Power: This switch activates AC power to the powered PA.

2. Volume: This control adjusts the volume level of the unit.

3. Thru: This XLR Jack is used to pass a signal from the Mic Input of the PW4P to another device such as a mixer or mic input device. If connected to a mixer with phantom power, the phantom power passes through to the mic input and can supply power to a condenser microphone.

4. MIC Input: This XLR input is designed for low-impedance microphones or equipment that has a Mic-level, balanced output. This input is not intended for line level signals, as distortion may occur.

5. LINE Input: This 1/4-inch unbalanced input (mono / stereo mixed) may be used to connect a line level signal, high-impedance microphone, keyboard, drum machine or other audio devices.

6. AC Power Cord Receptacle: Insert the PW4P's AC cord firmly into the AC receptacle. Be sure to use the cable provided with your PW4P. The power cord can be removed for storage or replacement if damaged. Note: Replace the AC cord if its protective jacket is damaged or ground pin is damaged or removed.

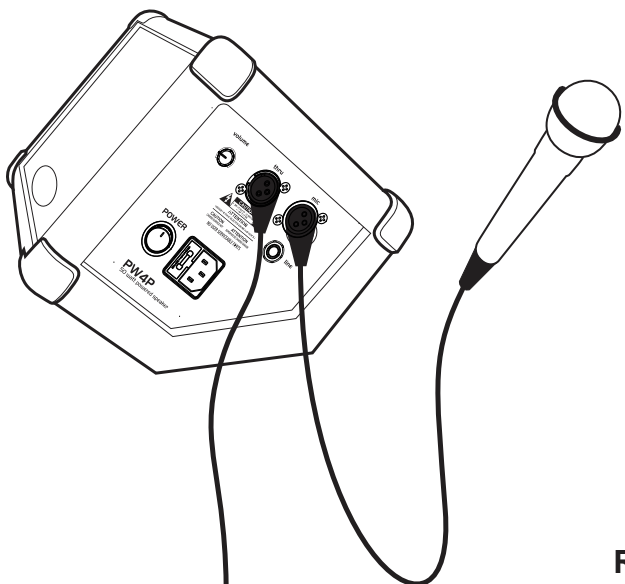

Additional Information: The PW4P has a mic stand adapter socket on the bottom of the cabinet. This allows the product to be placed on a microphone stand for optimum monitoring. Do not use with round base mic stand. Tripod stands only.

RECOMMENDED SET UP

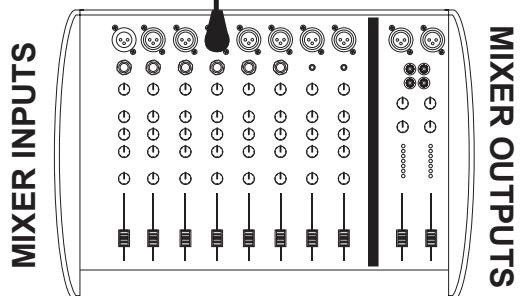

Plug microphone directly into the PW4P. Connect **THRU** jack to mic input on mixer. Your mixer outputs can then be connected to your main PA speakers and/or additional monitors.

If you are using a microphone that requires phantom power, the voltage supplied by your mixer will pass through the THRU input jack to the microphone.

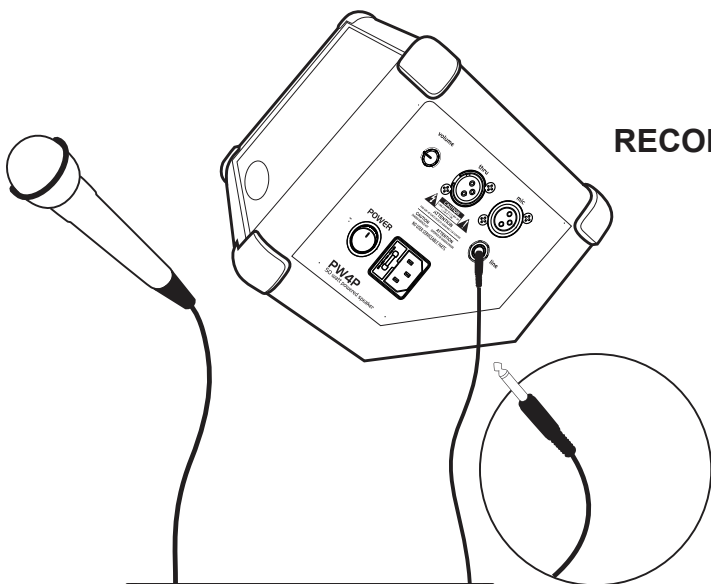

RECOMMENDED SET UP

Use an unbalanced line cable for the **LINE** input jack.

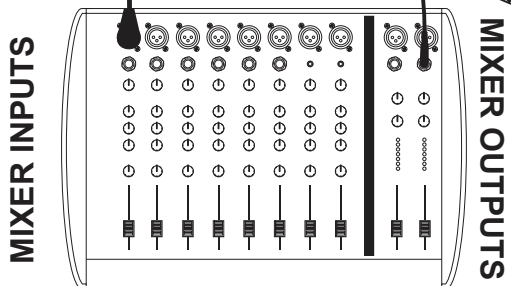

If you are connecting the PW4P to a mixer, use the 1/4" **LINE** input jack.

Connect an unbalanced line cable (also called a guitar or instrument cable) to an unbalanced output jack on your mixer.

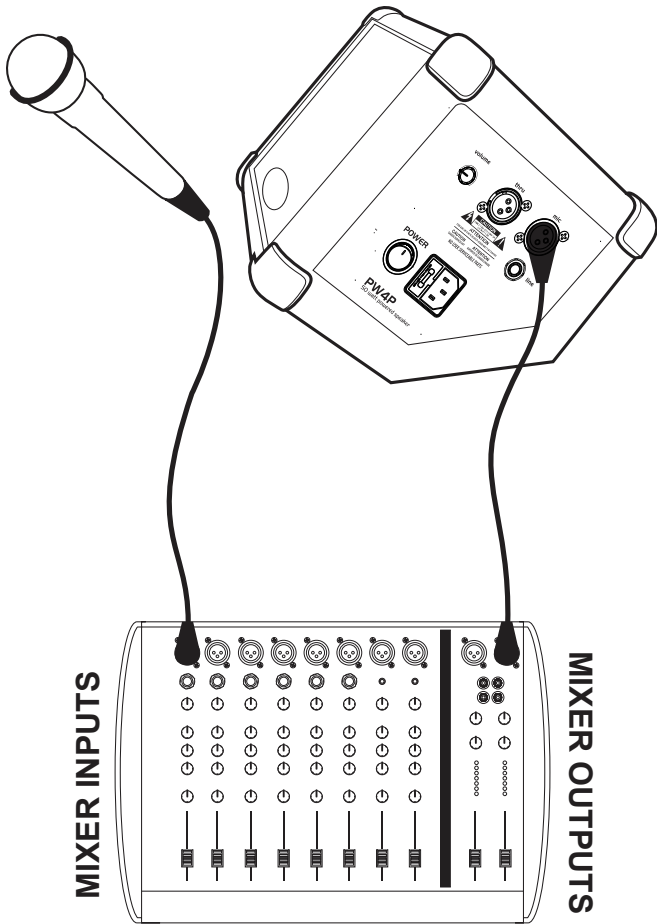

NOT RECOMMENDED SET UP

There may be an occasion where it is necessary to connect a line level signal to the microphone input. This is not recommended because the **MIC Input** is designed for low level signals.

If you must connect a line level signal to the mic input, make sure the volume controls on the PW4P and your mixer are set very low, and

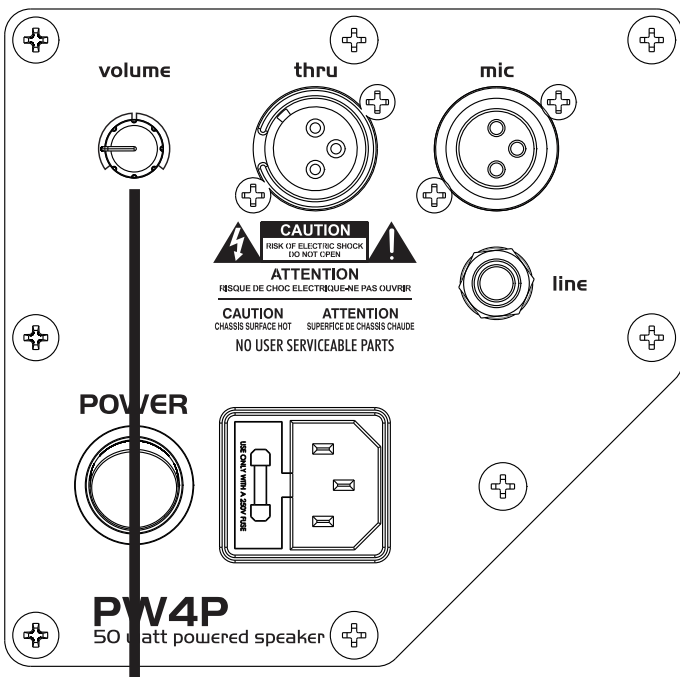

Volume controls on both the PW4P and your mixer should be set very low to minimize distortion.

PW4P Personal Monitor Specifications		
Output Power 1%	50W _{RMS}	8 Ohm load
Jack configuration	MIC	XLR Balanced Mic level input
	THRU	Passes thru signal on MIC input XLR jack
	Line Out	1/4" Balanced Line level input
Frequency Response	80HZ-20kHz	Actual response is tailored to speaker cabinet for accurate acoustical response.
Hum & Noise	-65dB	Residual Noise, all level controls 0% (minimum)
	-48dB	Nominal System Noise, all level controls at 50%
System Gain (1kHz)	+70dB	Mic to Speaker Output
	+56dB	Line to Speaker Output
Power Requirements	USA/Canada	120VAC/60Hz, 80W nominal
	Europe	230VAC/50Hz, 80W nominal
	UK	230VAC/50Hz, 80W nominal
	Australia	240VAC/50Hz, 80W nominal
	Japan	100VAC/50-60Hz, 80W nominal
Speakers	One 4½"	50W 8 Ohm
Horn	3 1/2"piezo driver	
Frequency Response	150HZ-20kHz	at rated SPL
Nominal Impedance	8 Ohms N	ot designed for external speakers
Dimensions & Weight	mm/kg	245 (width), 190 (height), 190 (depth), 4.75 kg
	Inches/Pounds	9.5 (width), 7.5 (height), 7.5 (depth), 10.5 lb

BLOCK DIAGRAM

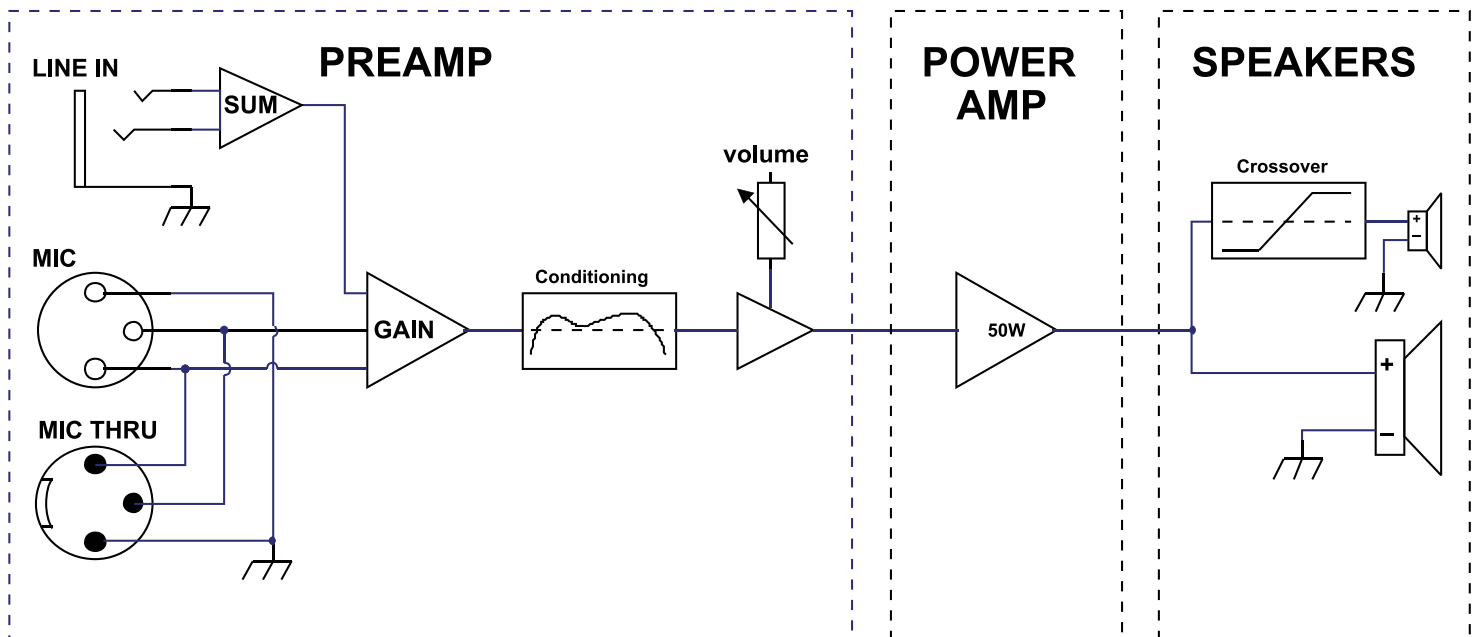

EC Declaration of Conformity

We: Kustom Musical Amplification INC.
3015 Kustom Drive
Hebron, Ky 41048
Tel: 1-859-817-7164 Fax: 1-859-817-7199

Declare that the product

Product name: Powerwerks

Product model number: PW4P

to which this declaration relates is in conformity with the following standards;

EN55013: 2001/+A1:
2003+A2: 2006 Limits and methods of measurement of radio disturbance characteristics of broadcast receivers and associated equipment.

EN55020: 2007 Electromagnetic immunity of broadcast receivers and associated equipment.

EN61000-3-2: 2006/+A1:
2009 + A2: 2009 Limits for harmonic current emissions (equipment input current < 16A per phase).

EN61000-3-3: 2008 Limitation of voltage fluctuations and flicker in low voltage supply systems for equipment with rated currents < 16A.

EN60065: 2002 + A1:2006
+ A11: 2008 + A2:2010
+ A12:2011 Safety requirements for main operated electronic and related apparatus for household and similar general use.

Following the provisions of EU Council Directive(s): 2004/108/EC and 2006/95/EC.

We the undersigned, hereby declare that the equipment specified above conforms to the aforementioned directive(s).

Name of authorized person: Fred Conrad, Manager Engineering services

Signature:  Date: 01 MAY, 2012

Kustom Musical Amplification INC.
3015 Kustom Drive
Hebron, Ky 41048
Tel: 1-859-817-7164 Fax: 1-859-817-7199

Powerwerks™

PW4P
OWNER'S MANUAL
www.powerwerks.com

Powerwerks
c/o Hanser Music Group
Hebron, KY 41048 USA
(859) 817- 7100

