



User Guide

## MI-909T Digital Stereo Rack Transmitter



**MIPRO Electronics Co., Ltd**  
Headquarters : 814 Pei-Kang Road, Chiayi,60096,Taiwan  
Tel : +886.5.238.0809 Fax : +886.5.238.0803  
www.mipro.com.tw mipro@mipro.com.tw

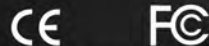

All rights reserved. Do not copy or forward without prior approvals MIPRO.  
Specifications and design subject to change without notice. MN 014/07

## **! IMPORTANT SAFETY INSTRUCTIONS !**

1. Read these instructions.
2. Keep these instructions.
3. Heed all warnings.
4. Follow all instructions.
5. Do not use this apparatus near water.
6. Clean only with a dry cloth.
7. Do not block any ventilation openings. Install in accordance with the manufacturer's instructions.
8. Do not install near any heat sources such as radiators, heat registers, stoves, or other apparatus (including amplifiers) that produce heat.
9. Do not defeat the safety purpose of the polarised or ground plug: A polarised plug has two blades with one wider than the other. The wide blade is provided for your safety. When the provided plug does not fit into your outlet, consult an electrician for replacement of the obsolete outlet.
10. Protect the power cord from being walked on or pinched particularly at plug, convenience receptacles, and the point where they exit from the apparatus.
11. Only use attachments/accessories specified by the manufacturer.
12. Use only with a cart, stand, tripod, bracket, or table specified by the manufacturer, or sold with the apparatus. When a cart is used, use caution when moving the cart/apparatus combination to avoid injury from tip-over.
13. Unplug this apparatus during lightning storms or when unused for long periods of time.
14. Refer all servicing to qualified service personnel. Servicing is required when the apparatus has been damaged in any way, such as power-supply cord or plug is damaged, liquid has been spilled or objects have fallen into the apparatus, the apparatus has been exposed to rain or moisture, does not operate normally, or has been dropped.
15. To reduce the risk of fire or electric shock, do not expose this apparatus to rain or moisture.
16. Apparatus should not be exposed to dripping or splashing and no objects filled with liquids, should be placed on the apparatus.
17. Use only with the battery which specified by manufacturer.
18. The power supply cord set is to be the main disconnected device.



## **WARNING**

1. **FOR OUTDOOR USE:**  
To reduce the risk of fire or electric shock, do not expose this apparatus to rain or moisture.
2. **UNDER WET LOCATION:**  
Apparatus should not be exposed to dripping or splashing and no objects filled with liquids, such as vases should be placed on the apparatus.
3. **SERVICE INSTRUCTIONS:**  
CAUTION - These servicing instructions are for use by qualified service personnel only. To reduce the risk of electric shock, do not perform any servicing other than that contained in the operating instructions unless you are qualified to do so.

	This symbol indicates that dangerous voltage constituting a risk of electric shock is present within this unit.
	This symbol indicates that there are important operating and maintenance instructions in the literature accompanying this unit.

### FCC

THIS DEVICE COMPLIES WITH PART 74 AND PART 15 SUBPART B OF THE FCC RULES OPERATION IS SUBJECT TO THE FOLLOWING TWO CONDITIONS:

- (1) This device may not cause interference.
- (2) This device must accept any interference, including interference that may cause undesired operation of the device.

This equipment complies with FCC RF radiation exposure limits set forth for an uncontrolled environment.

### IC

This device complies with Industry Canada licence-exempt RSS-123 ISSUE 2 / RSS-310 ISSUE 3 standards. Operation is subject to the following two conditions:

- (1) this device may not cause interference, and
- (2) this device must accept any interference, including interference that may cause undesired operation of the device.

Le présent appareil est conforme aux CNR d'Industrie Canada applicables aux appareils radio exempts de licence. L'exploitation est autorisée aux deux conditions suivantes :

- (1) l'appareil ne doit pas produire de brouillage, et
- (2) l'utilisateur de l'appareil doit accepter tout brouillage radioélectrique subi, même si le brouillage est susceptible d'en compromettre le fonctionnement.

**Contents**

- 1 Profile
- 2 Front Panel Controls and Indicators
- 3 Rear Panel Connectors
- 4 Operating Instructions
- 6 LCD Panel Operating Instructions
- 25 MIPRO's Proprietary ACT Sync Function
- 27 Network Connection
- 28 Rackmount Kit
- 29 Cautions & Recommendations

**Disposal** Dispose of any unusable devices or batteries responsibly and in accordance with any applicable regulations.



Disposing of used batteries with domestic waste is to be avoided!

Batteries / NiCad cells often contain heavy metals such as cadmium(Cd), mercury(Hg) and lead(Pb) that makes them unsuitable for disposal with domestic waste. You may return spent batteries/ accumulators free of charge to recycling centres or anywhere else batteries/accumulators are sold.

2005-08-13

By doing so, you contribute to the conservation of our environment!

**Profile**

Thank you for choosing a MIPRO IEM product.

This industry's first digital IEM system is engineered to meet the stringent requirements demanded in professional touring and installation applications. Featuring digitally encrypted technology and unparalleled digital audio performance and transmission reliability, superior frequency response characteristics from 20Hz low-frequency sound clearly exceeds analog IEM systems currently on the market.

**Included Parts**

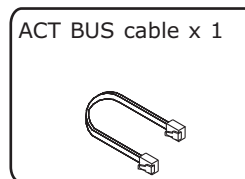
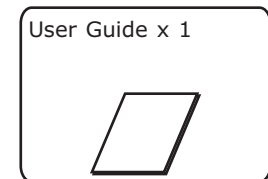
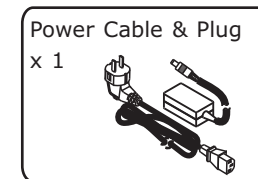
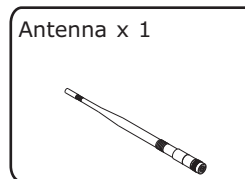

## Rack Transmitter

### Front Panel Controls and Indicators

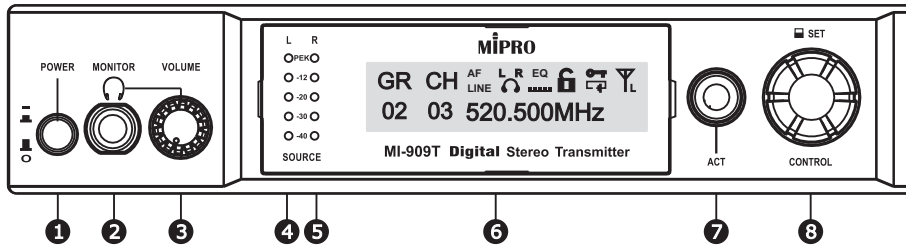

- ❶ **Power Button:** Press to turns the unit on and off.
- ❷ **Headphone Monitoring:** Insert a 6.3  $\phi$  mm headphone here.
- ❸ **Headphone Volume:** Adjust for volume loudness.
- ❹ **Left Audio Indicators:** The red Peak LED indicates the inputs are overdriven.
- ❺ **Right Audio Indicators:** The red Peak LED indicates the inputs are overdriven.
- ❻ **Front Panel Screen:** Display settings and parameters.
- ❼ **ACT Sync Button & Window:** Press ACT button to sync frequency from transmitter to bodypack receivers.
- ❽ **Control Knob:** For setting changes.

## Rack Transmitter

### Rear Panel Connectors

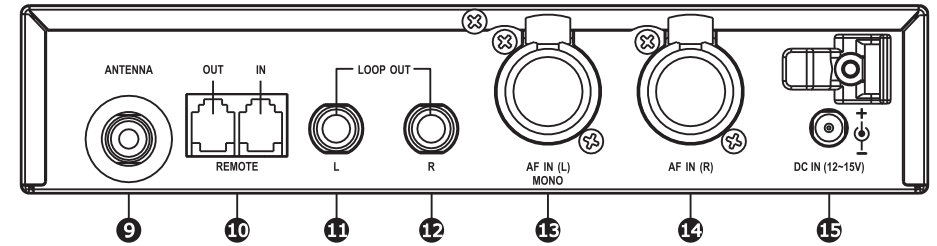

- ❹ **Antenna Connector (TNC):** Attach supplied antenna.
- ❺ **ACT Bus:** Attach supplied ACT Bus cable for remote control option.
- ❻ **LOOP OUT Left:** Sends a copy of the audio signal going into the transmitter to another device.
- ❼ **LOOP OUT Right:** Sends a copy of the audio signal going into the transmitter to another device.
- ❽ **Audio Inputs Left (Mono):** Connect to balanced or unbalanced outputs. Accepts both 1/4-inch or male XLR connectors.
- ❽ **Audio Inputs Right:** Connect to balanced or unbalanced outputs. Accepts both 1/4-inch or male XLR connectors.
- ❽ **12~15V DC Power:** Connect the transmitter to a power outlet using the supplied power plug & cable.

The MI-909 system consists one MI-909T digital rack unit stereo transmitter and will transmit to one or more MI-909R digital stereo bodypack receivers.

## Operating Instructions

### 1. Rear Antenna Installation

Attach supplied antenna to the transmitter. Ensure the antenna and transmitter have the same frequency band for optimal transmitting efficiency

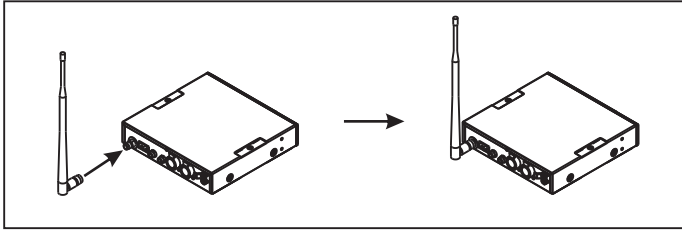

### 2. Front Antenna Installation

Install an option FB-71 rear-to-front rackmount kit with cable. Attach supplied antenna to the front for improved optimal transmitting efficiency.

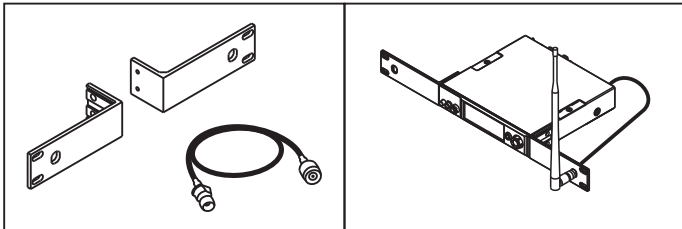

### 3. External Antenna Installation

Install optional MIPRO AT-100 & MS-90 antennas with microphone stands and high quality coaxial cable for improved performance. Ensure antennas are installed and positioned higher than the crowds and away from obstructions.

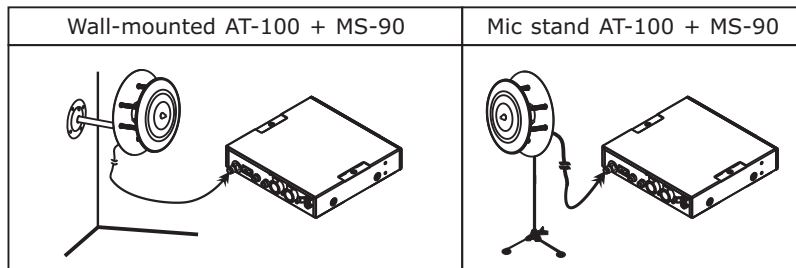

### 4. Power

Connect the transmitter to a power outlet using the supplied power plug & cable.

### 5. Power Button

Press to turns the unit on and off.

### 6. Audio Inputs

Stereo or Mono outputs. Left audio input for Mono. Accepts both 1/4-inch or male XLR connectors.

### 7. Headphone Monitoring

Insert a 6.3  $\phi$  mm headphone here.

### WARNING:

To prevent possible hearing damage, do not listen at high volume levels for long periods.

### LCD Panel Operating Instructions

1. Main LCD Screen provides access to menus and displays a summary of transmitter settings

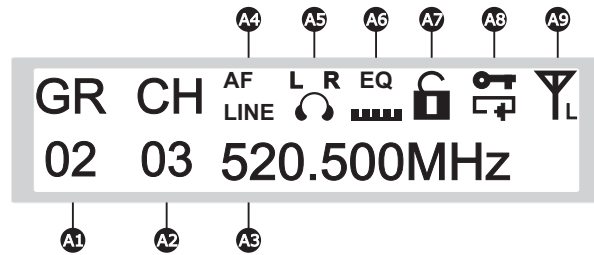

- A1** GR: Group
- A2** CH: Channel
- A3** Working Frequency in MHZ
- A4** AF: Audio Frequency
- A5** Left Right Channel
- A6** EQ icon: Equalizer
- A7** Lock Icon
- A8** Encryption key Icon
- A9** RF output Icon

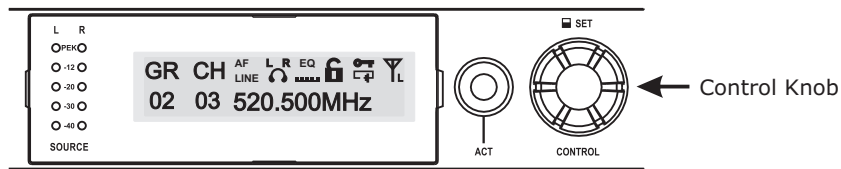

### 2. Control Knob: Menu Settings

- A. Operating Instructions:
  - a. Press & release Control Knob to access menus.
  - b. Turn right or left to access specific menus. Press to confirm setting changes.

### 3. Listed Menus

> GROUP & CHANNEL  
USER FREQUENCY



> RF POWER  
AF SENSITIVITY



> AF INPUT  
SOUND MODE



> EQUALIZER  
NAME SETTING



> NET ADDRESS  
SET LOCK



> ENCRYPTION  
SECURE KEY



> FREE SCAN  
EXIT & SAVE

(1) GR CH: GROUP & CHANNEL Settings

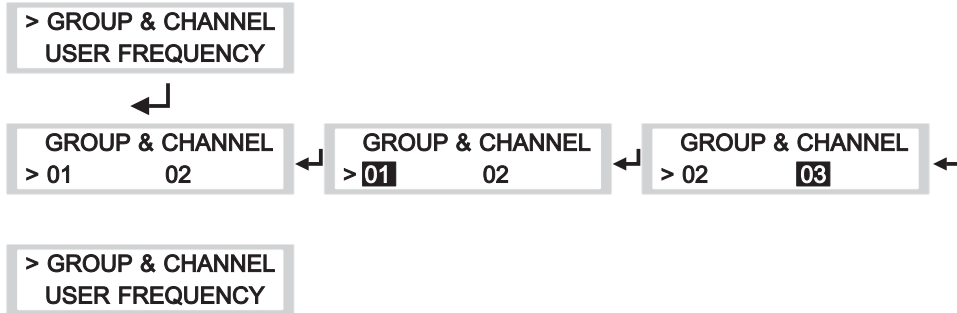

A. Operating Instructions:

- a. Locate GROUP & CHANNEL menu, press to activate setting.
- b. Turn left or right for desired GROUP. Press to save.
- c. Turn or right for desired CHANNEL. Press to save.
- d. Once saved, indicator returns to listed menus.

Control Knob Operating Instructions



(2) USER FRQUENCY Settings

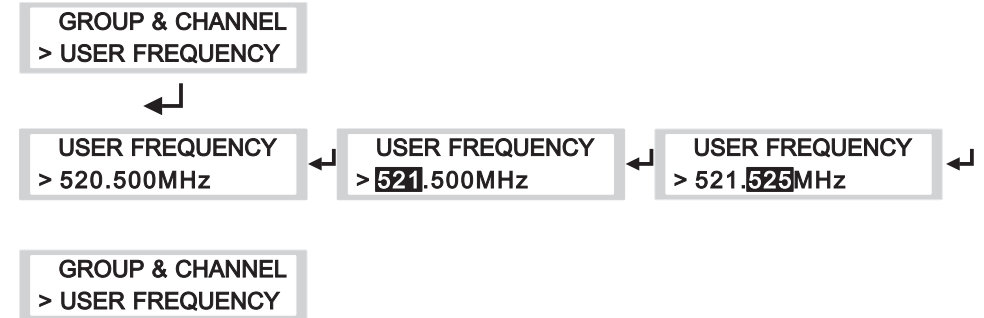

A. Operating Instructions:

- a. Locate USER FREQUENCY menu, press to activate setting.
- b. Press to enter setting (highlighted in black). Press to save.
- c. Frequency selection: adjustable in increments of 1 MHz or 25 kHz.
- d. Once saved, indicator returns to listed menus.

**Notes:**

- ① Factory pre-set Group and Channel have corresponding user frequencies. " \* \* " signs appear in GR & CH if user frequency are set-up manually.
- ② Once a new frequency is set-up, do not forget to align and sync with a bodypack receiver by performing sync protocol by pressing ACT sync button.

(3) RF POWER: Radio Frequency (RF) POWER Settings

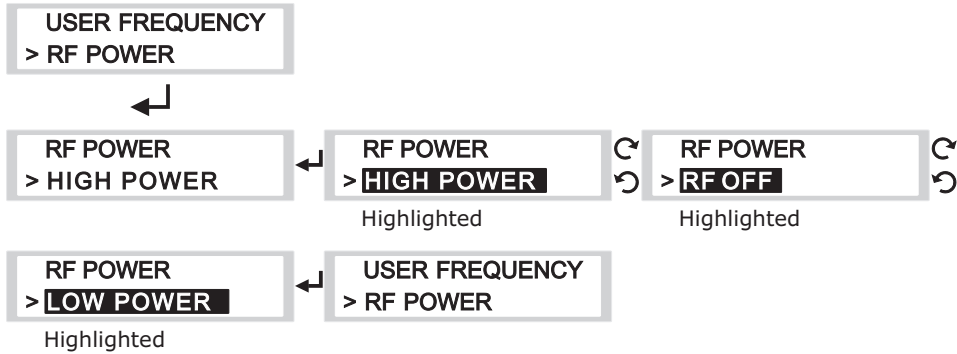

A. Operating Instructions:

- Locate RF POWER menu, press to activate setting.
- Press to enter setting (highlighted in black). Turn for HIGH POWER, RF OFF or LOW POWER. Press to save.
- Once saved, indicator returns to listed menus.

Notes:

- High power is country dependent. Power levels vary by region or country.
- RF OFF enables no RF power emitting without powering off the transmitter.
- icon: RF POWER setting is OFF.  
 icon: RF POWER setting is LOW.  
 icon: RF POWER setting is HIGH.

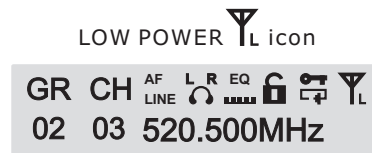

(4) AF SENSITIVITY: Audio (AF) SENSITIVITY Settings

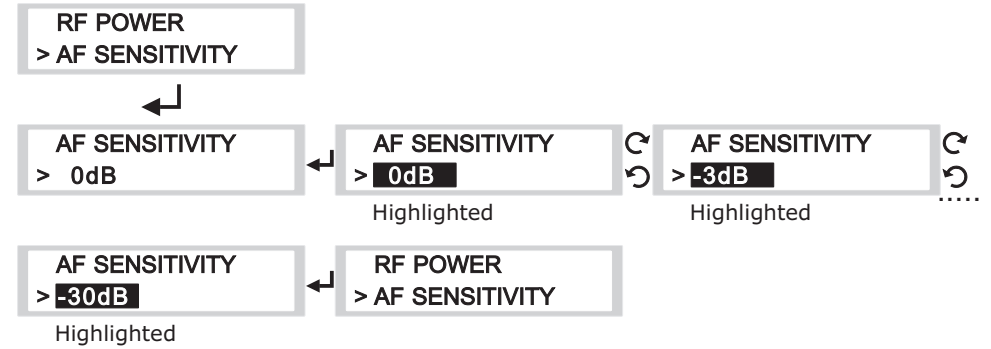

A. Operating Instructions:

- Locate AF SENSITIVITY menu, press to activate setting.
- Press to enter setting (highlighted in black). Turn for desired parameters. Press to save.
- Once saved, indicator returns to listed menus.

Notes:

- Three bar indicators from the SOURCE are optimal. The red clip PEAK LED indicates the inputs are overdriven. Reduce the level at the audio source or change the AF sensitivity setting if 0 dB is still too high.
- If less than two bar indicators from the SOURCE with -30 dB setting, change AF INPUT to MIC LEVEL to improve AF input sensitivity level.



(5) AF INPUT: Audio (AF) INPUT Settings

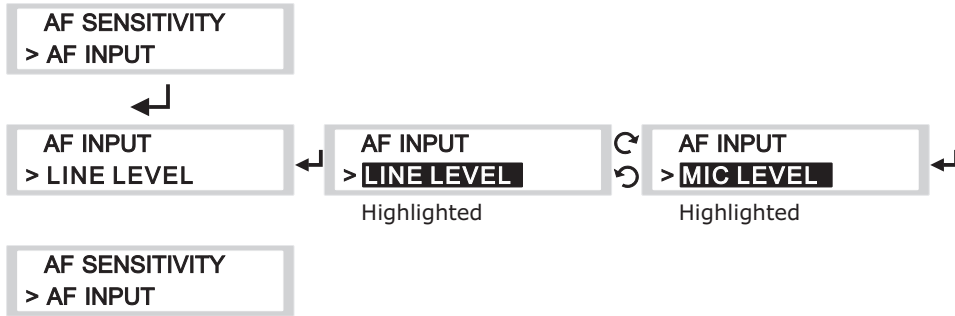

A. Operating Instructions:

- a. Locate AF INPUT menu, press to activate setting.
- b. Press to enter setting (highlighted in black). Turn for LINE LEVEL or MIC LEVEL. Press to save.
- c. Once saved, indicator returns to listed menus.

**Notes:**

- ① Select appropriate output device with proper audio input signal strength to avoid distortion when it is set too high and deteriorated S/N ratio when it is set too low.
- ② <sup>AF</sup><sub>MIC</sub> icon: MIC LEVEL.  
<sup>AF</sup><sub>LINE</sub> icon: LINE LEVEL.

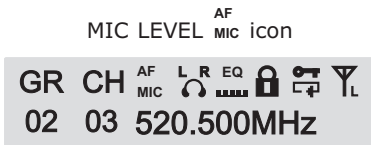

(6) SOUND MODE: SOUND MODE Settings

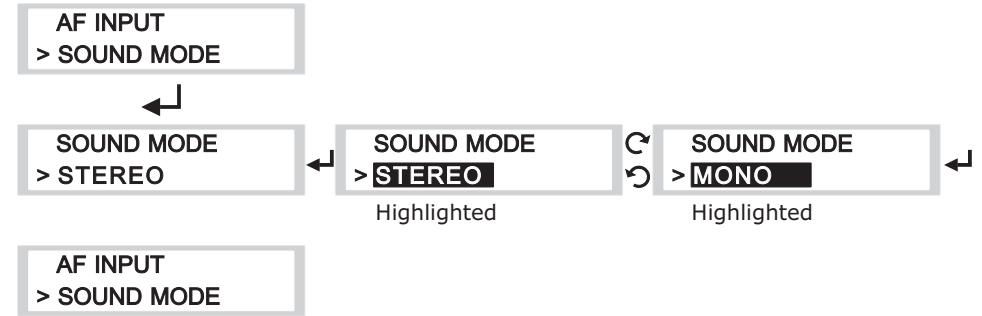

A. Operating Instructions:

- a. Locate SOUND MODE, press to activate setting.
- b. Press to enter setting (highlighted in black). Turn for STEREO or MONO. Press to save.
  - ① <sup>L R</sup> icon: STEREO.
  - ② <sup>L X</sup> icon: MONO.
- c. Once saved, indicator returns to listed menus.

**Note:**

- ① Plug AF IN (L) only for MONO sound.



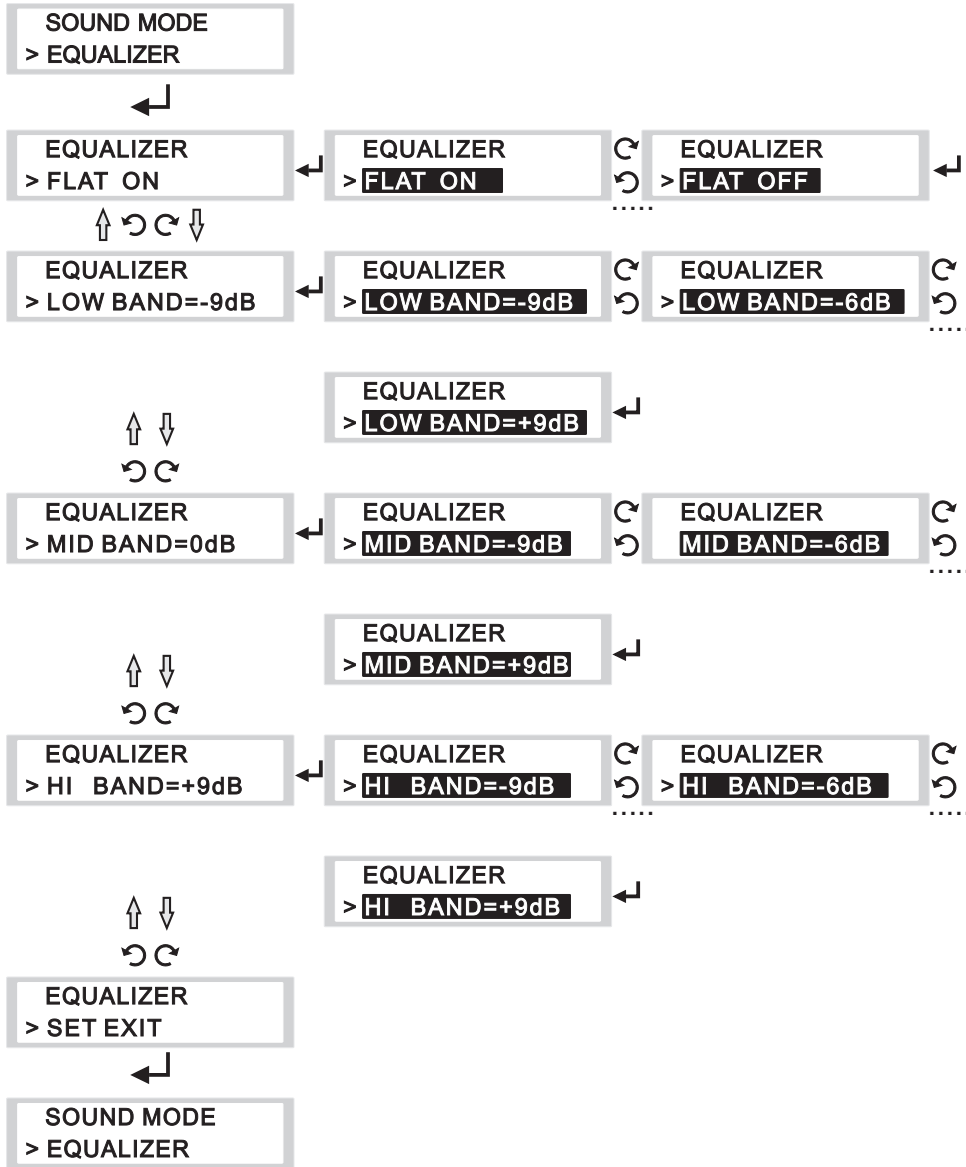

(7) EQUALIZER: EQUALIZER Settings



A. Operating Instructions

- a. Locate EQUALIZER, press to activate setting.
- b. Press to enter setting (highlighted in black). Turn for FLAT→LOW BAND→MID BAND→HI BAND→SET EXIT. Press to save.
  - ① FLAT: FLAT ON or FLAT OFF.
  - ② LOW BAND/ MID BAND/ HI BAND:
    - 9dB to +9dB: adjustable in increments of 3 dB.
  - ③ SET EXIT: Press SET EXIT to return to main LCD screen.
- c. Once save, press SET EXIT to return to listed menus.

Notes:

- ①  icon: FLAT ON.
- ②  icon: FLAT OFF.

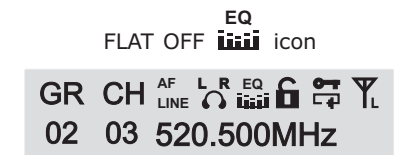
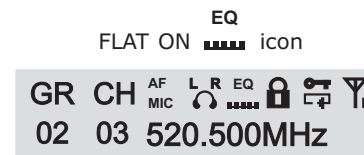

(8) NAME SETTING: NAMM SETTING Settings

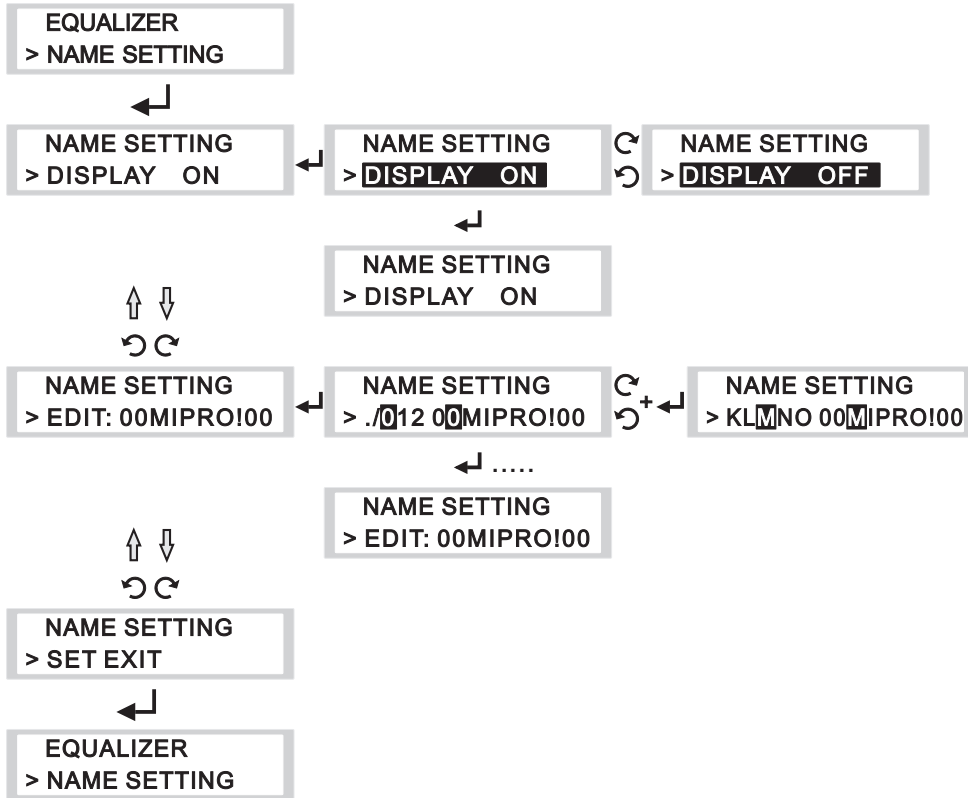

A. Operating Instructions

- Locate NAME SETTING menu, press to activate setting.
- Press to enter setting (highlighted in black). Turn for DISPLAY ON →EDIT: 00MIPRO!00 →SET EXIT.
  - DISPLAY: Turn for DISPLAY ON or DISPLAY OFF.
  - EDIT: Up to 10 alphanumeric characters and symbols.
  - SET EXIT: Press SET EXIT to return to main LCD screen.
- Once save, press SET EXIT to return to listed menus.

**Note:**

- DISPLAY ON – Alphanumeric characters are shown.

DISPLAY "ON"



Displays alphanumeric characters

DISPLAY "OFF"



Display User Frequency

## Digital Stereo Rack Transmitter

(9) NET ADDRESS Settings: For PC control network

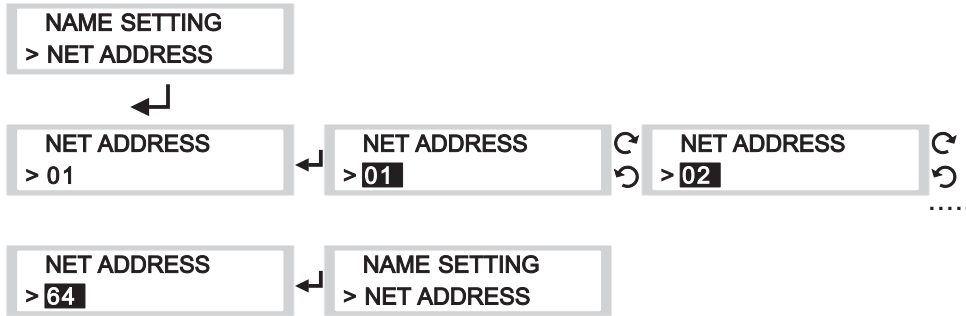

A. Operating Instructions:



- Interface with ACT-BUS for pc-control network. Can monitor up to 64 channels.
- 01~64 transmitter addresses can be setup and monitor via an optional PC-control software remotely. All transmitters must be connected to a dedicated address for network identification.
- Locate NET ADDRESS menu, press to activate setting.
- Press to enter setting (highlighted in black). Press to save.
- Once saved, indicator returns to listed menus.

## Digital Stereo Rack Transmitter

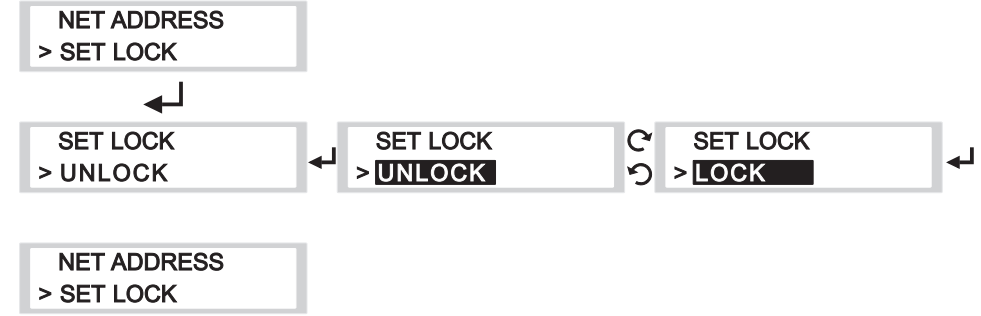
(10) SET LOCK Settings : For front panel lock



A. Operating Instructions:

- Locate SET LOCK menu, press to activate setting.
- Press to enter setting (highlighted in black) for UNLOCK or LOCK. Press to save.
  -  icon: UNLOCK.
  -  icon: LOCKED.
- Once save, press to return to listed menus.
- Once  icon appears the panel is locked. No new settings can be changed. Need to unlock the panel first prior to make new setting changes.

 icon: LOCKED

GR CH AF L R EQ     
02 03 520.500MHz



 icon: UNLOCK

GR CH AF L R EQ     
02 03 520.500MHz

(11) ENCRYPTION  : To add encryption or decryption



A. Operating Instructions:

- a. Locate ENCRYPTION menu, press to activate setting.
- b. Press to enter setting (highlighted in black) for ON or OFF. Press to save.
  - ①  icon: Encryption key is ON
  - ② No  icon: Encryption key is OFF (not activated)
- c. Once save, press to return to listed menus.
 

\*\* Be sure to press ACT button for synchronization from transmitter to bodypack receiver after each time an Encryption is activated.
- d. After a new encryption key is added to the transmitter, the transmitter frequency is no longer valid and compatible with existing bodypack receivers. To be compatible, perform the ACT sync function.

 icon: ENCRYPTION ON

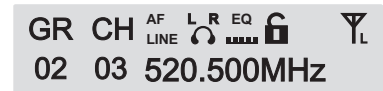
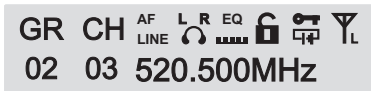

No  icon: ENCRYPTION OFF



(12) SECURE KEY Settings: Adding encryption key option



A. Operating Instructions:



- a. Locate SECURE KEY menu, press to activate setting.
- b. Press to enter setting (highlighted in black) for STATIC or SCROLL. Press to save.
  - ① STATIC  icon: No new encryption key is generated each time the ACT sync button is pressed.
  - ② SCROLL  icon: A new encryption key is generated each time the ACT sync button is pressed.
- c. Once save, press to return to listed menus.
- d. 128bit encryption key is generated randomly and very difficult to break or crack for eavesdropping occurrences.

**Notes:**

- ① STATIC encryption method is ideal for one transmitter to multiple receivers.
- ② SCROLL encryption method is ideal for one transmitter to one receiver.

## Digital Stereo Rack Transmitter

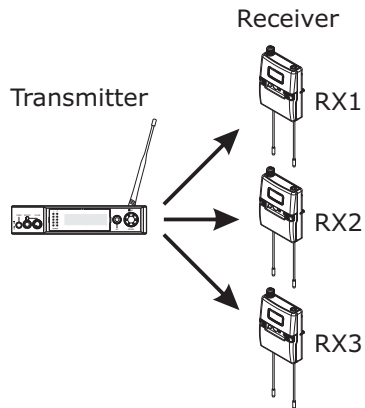

STATIC: existing encryption

GR CH AF L R EQ     
02 03 520.500MHz



STATIC encryption mode is ideal for multiple receivers

SCROLL: new encryption

GR CH AF L R EQ     
02 03 520.500MHz

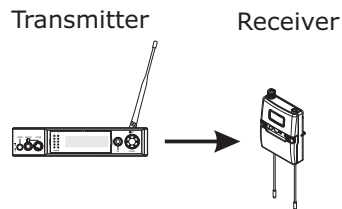

SCROLL encryption mode is ideal for a single receiver

## Digital Stereo Rack Transmitter

(13) FREE SCAN Settings: SCAN for an interference-free transmitter channel

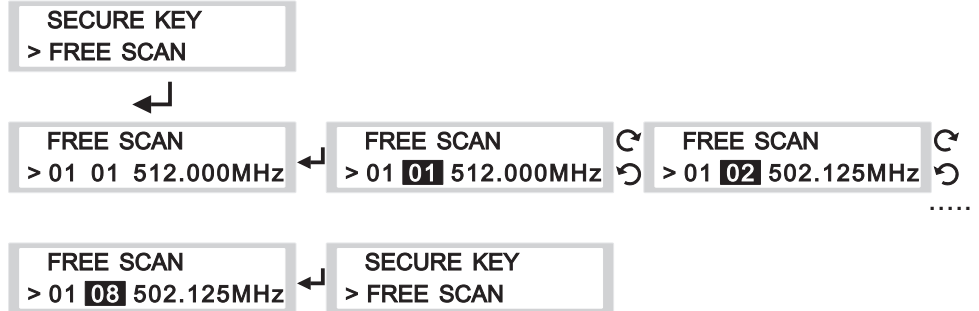

### A. Operating Instructions:

- Locate FREE SCAN menu, press to activate setting.
- Press to enter setting (highlighted in black). Turn left or right to scan for an open Channel within the specified Group. Press to save.
- Once save, press to return to listed menus.
- FREE SCAN scans for an interference-free channel within the specified Group only.
- Use FREE SCAN to analyze the RF environment for interference and identify available frequencies. During scanning process the transmitter stops transmission. When no interference-free channel is located, it reverses automatically back to the original channel.

**Note:** When performing a FREE SCAN

- Turn on potential sources of interference such as other wireless systems or devices, computers, CD players, large LED panels, effects processors, and digital rack equipment so they are operating as they would be during the presentation or performance (so the scan will detect and avoid any interference they generate).

(14) EXIT & SAVE Settings: Save changes and exit



A. Operating Instructions:

- a. Press to exit and return to the main LCD screen.

## MIPRO's Proprietary ACT Sync Function

### What is ACT ?

1. ACT is short for Automatic Channel Targeting. ACT is a proprietary sync technology developed first by MIPRO in the professional audio industry. Consequently, ACT sync has become an industry-standard for fast, easy and precise frequency synchronization between transmitter and receiver.

### Features

1. Frequency do not require an external tool for adjustment.
2. Precise and fast synchronization.
3. Frequency is synchronized and saved and ready for repeat usage.

### Operating Instructions?

1. Press the ACT sync button on the rack transmitter to start the synchronization.
2. ACT SYNC word with moving "... " appears on the rack transmitter screen.
3. Align the ACT sync windows of both receiver & transmitter within 30cm.
4. ACT SYNC word with moving "... "disappears during a successful sync and returns back to main LCD screen.
5. ACT FAIL appears during a failed sync.
6. Repeat step 1 to 5.

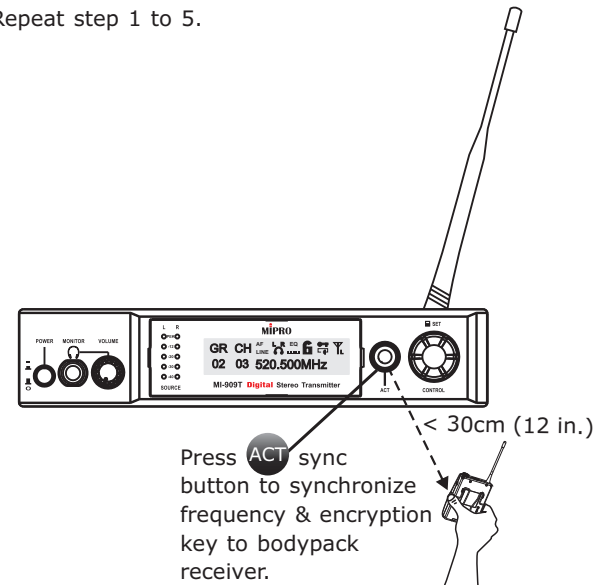

(14) ACT Synchronization

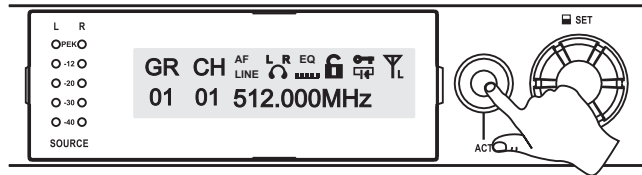

Press ACT sync button

ACT SYNC . . . . .  
> 01 01 512.000MHz

During Synchronization...

ACT FAIL  
> 01 01 512.000MHz

ACT FAIL appears during a failed synchronization

A. Operating Instructions:

- a. Press the ACT sync button on the transmitter to activate the synchronization.
- b. Align the ACT sync windows of both transmitter and receiver within 30cm (12-inch) and 10 seconds.
- c. During syncing, the transmitter LCD screen display is flashing "ACT SYNC ...".
- d. If synchronization is done successfully, the transmitter LCD return to the main screen.
- e. If synchronization is done unsuccessfully, it displays SYNC FAIL. Repeat steps 1-4 until is done successfully.

\*\* During ACT sync, the frequency is synchronized from transmitter to receiver. Other setting as an encryption key (SCROLL or STATIC) is also synchronized during the transfer.

Network Connection

Network Interface

1. See connection diagram below for connection from REMOTE connectors located at the rear panel of the transmitter via RS-232 or USB connection to RS-232 COM PORT or USB PORT.

Wiring Instructions

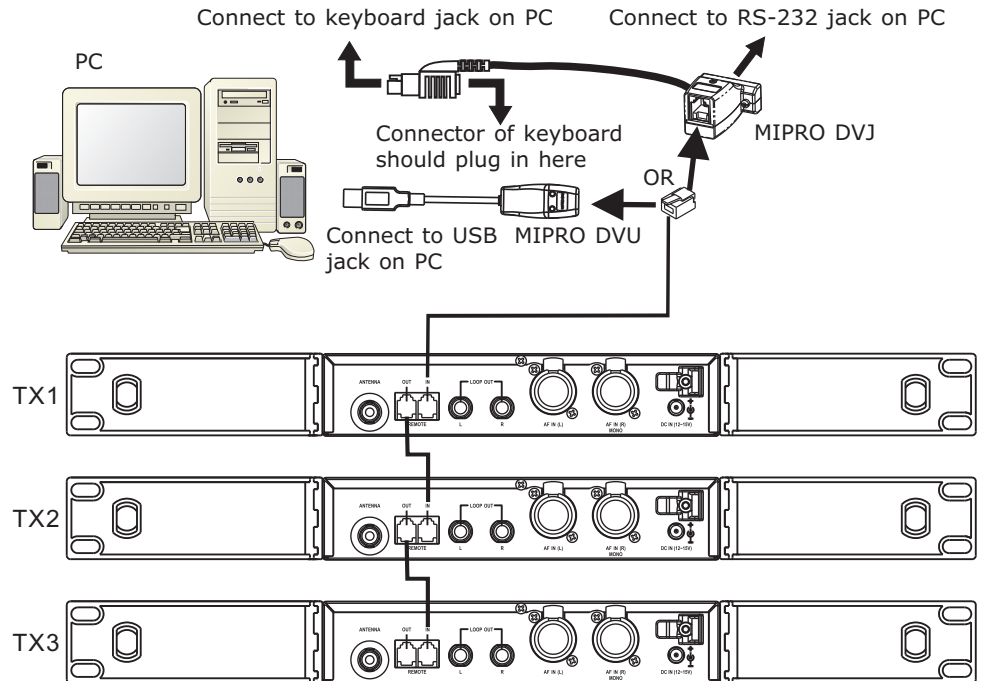

1. Connect REMOTE OUT to REMOTE IN of another transmitter for interconnection of other transmitters. First transmitter (TX) 1, connect REMOTE IN to a MIPRO-DV.
2. Up to 64 transmitters can be linked and connected.
3. Up to 300 meters of internet connection is possible. However, we recommend for up to 100 meters to ensure optimal performance and quality of high-speed transmission.



## Rackmount Kit

Rack-mounting a 1/2 rack unit

- Rack-mount with an optional FB-71 rack-mount kit and fasten accordingly.

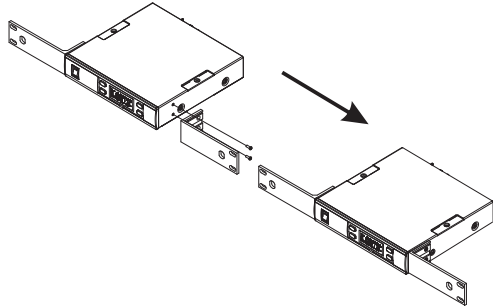

Rack-mounting two 1/2 rack units side-by-side

- Remove top & bottom screws.
- Insert top and bottom plates to joint two transmitters. Fasten screws.
- Rack-mount with an optional FB-72 rack-mount kit.

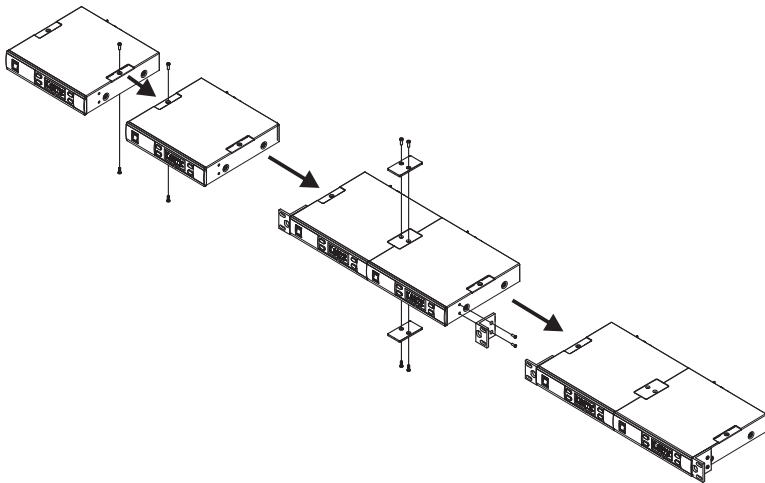

## Cautions & Recommendations

- Do not use the same frequency bands when mixing MIPRO IEM and MIPRO wireless microphone systems to avoid potential interferences.
- When using RG-58 or 3D cable, do not exceed 5 meters and use 50Ω coaxial cable to transmit signals to the external antenna.
- If possible, maintain line-of-sight between transmitter and receivers for optimal reception quality during outdoor or indoor performances. Indoor reception quality tend to degrade due to obstacles and objects absorbing radio waves making the reception distance shorter compared with outdoor performances.
- Power supply voltage should not be less than 12V and not higher than 15V. Ensure at least 500mA or more output current. Deficient current causes operating voltage instability or malfunction and exceeding current causes shorter the product life cycle and possible short or damaging circuits.

### Note

- Refer to actual product in the event of product description discrepancy.
- Frequency range and maximum deviation comply with the regulations of different countries.