



# MAS 1 MAS 133

Quick Guide  
 Kurzanleitung  
 Guide de démarrage rapide  
 Guida rapida  
 Instrucciones resumidas  
 Instruções resumidas  
 Beknopte gebruiksaanwijzing  
 Krótka instrukcja obsługi  
 Snabbguide

Kort vejledning  
 Pikaohje  
 Γρήγορος οδηγός  
 Kısa Kılavuz  
 Краткая инструкция  
 快速指南  
 快速使用指南  
 クイックガイド  
 퀵 가이드

**SENNHEISER**



[www.sennheiser.com/download](http://www.sennheiser.com/download)

Sennheiser electronic GmbH & Co. KG

Am Labor 1, 30900 Wedemark, Germany  
[www.sennheiser.com](http://www.sennheiser.com)

Printed in Germany, Publ. 11/23, 549116/A03

## In the box

### MAS 133

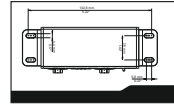
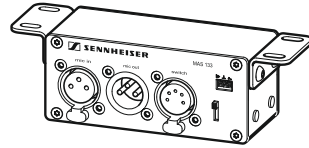

### MAS 1

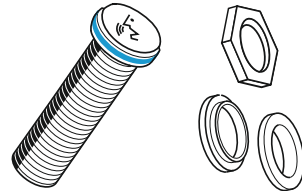

## Microphone behavior

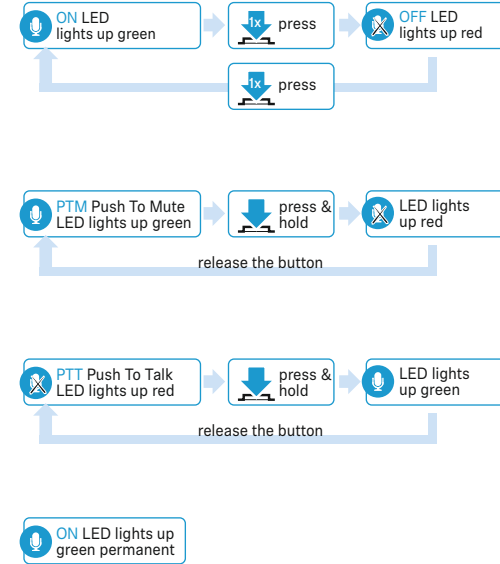
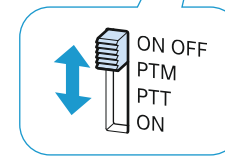
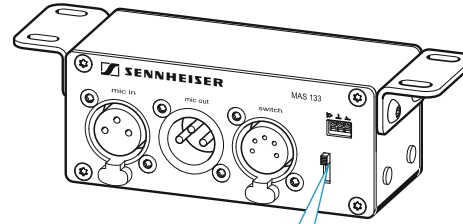

## Setup MAS 133

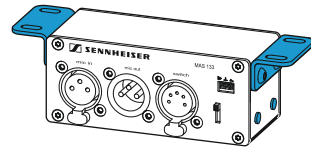

OR

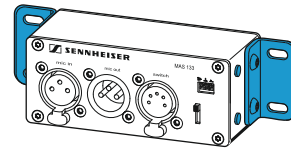

OR

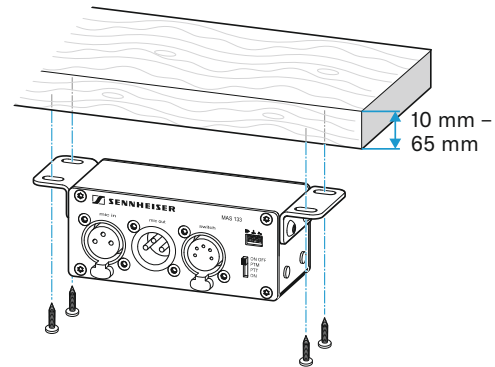
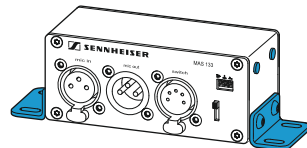

10 mm – 65 mm

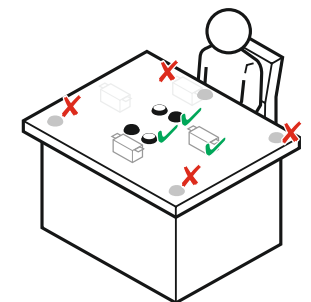
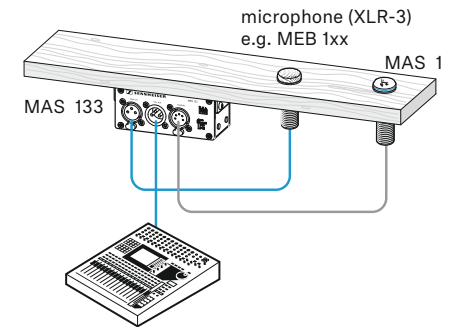

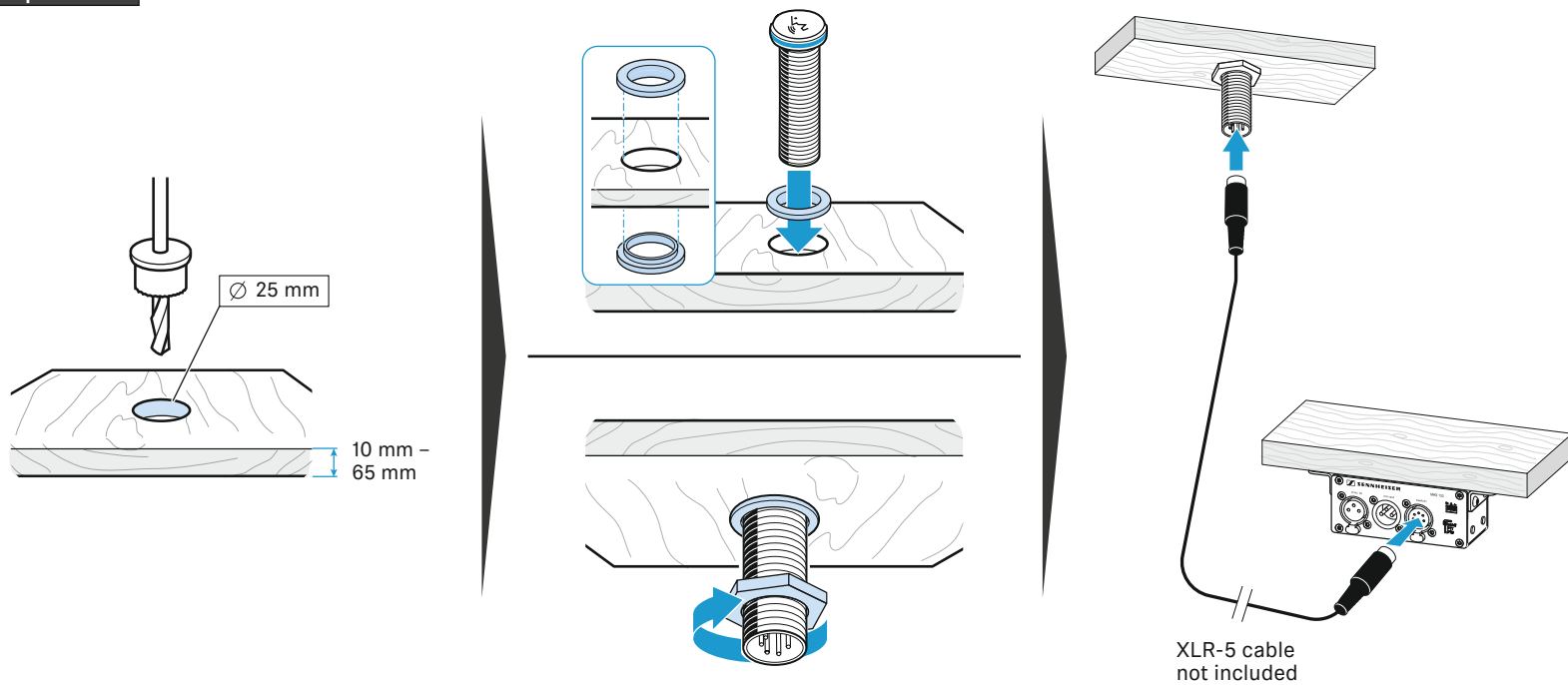

## Setup MAS 1

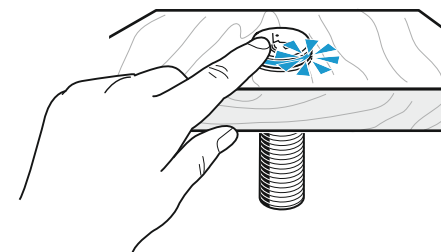

## LED status



-  lights up green: microphone active
-  lights up red: microphone muted

## Specifications

	MAS 1	MAS 133
Power supply	12 V phantom power (max. 1.5 mA)	48 V phantom power (P48) via <b>MIC IN</b>
Current consumption	LED ring 3 mA	
Logic output		high level output voltage > 2.4 V low level output voltage < 0.4 V
Connector	XLR-5M	<b>MIC IN:</b> XLR 3F <b>MIC OUT:</b> XLR 3M <b>SWITCH:</b> XLR 5F 3x terminal
Temperature	operation: -10 °C – +50 °C storage: -25 °C – +70 °C	
Dimensions	total height: approx. 81 mm installation height: approx. 8 mm head of button: Ø approx. 29 mm thread: Ø approx. 20 mm rubber rings: Ø approx. 23 mm thread: M20 x 1.5	approx. 150 x 44 x 44 mm
Weight	approx. 60 g	approx. 212 g