

MIPRO®

User Guide

MA-100DB | MA-100SB

Personal Wireless PA System



MA-100DG | MA-100SG

2.4 GHz Personal Wireless PA System



MIPRO®
MICROPHONE PROFESSIONALS

MIPRO Electronics Co., Ltd

Headquarters: 814 Pei-Kang Road, Chiayi, 60096, Taiwan
Tel : +886.5.238.0809 Fax : +886.5.238.0803
www.mipro.com.tw mipro@mipro.com.tw



2CE598B

All rights reserved. MN 019/06

Do not copy or forward without prior approvals MIPRO.

Specifications and design subject to change without notice.

! IMPORTANT SAFETY INSTRUCTIONS !

1. Read these instructions.
2. Keep these instructions.
3. Heed all warnings.
4. Follow all instructions.
5. Do not use this apparatus near water.
6. Clean only with a dry cloth.
7. Do not block any ventilation openings. Install in accordance with the manufacturer's instructions.
8. Do not install near any heat sources such as radiators, heat registers, stoves, or other apparatus (including amplifiers) that produce heat.
9. Do not defeat the safety purpose of the polarised or ground plug: A polarised plug has two blades with one wider than the other. The wide blade is provided for your safety. When the provided plug does not fit into your outlet, consult an electrician for replacement of the obsolete outlet.
10. Protect the power cord from being walked on or pinched particularly at plug, convenience receptacles, and the point where they exit from the apparatus.
11. Only use attachments/accessories specified by the manufacturer.
12. Use only with a cart, stand, tripod, bracket, or table specified by the manufacturer, or sold with the apparatus. When a cart is used, use caution when moving the cart/apparatus combination to avoid injury from tip-over.
13. Unplug this apparatus during lightning storms or when unused for long periods of time.
14. Refer all servicing to qualified service personnel. Servicing is required when the apparatus has been damaged in any way, such as power-supply cord or plug is damaged, liquid has been spilled or objects have fallen into the apparatus, the apparatus has been exposed to rain or moisture, does not operate normally, or has been dropped.
15. To reduce the risk of fire or electric shock, do not expose this apparatus to rain or moisture.
16. Apparatus should not be exposed to dripping or splashing and no objects filled with liquids, should be placed on the apparatus.
17. Use only with the battery which specified by manufacturer.
18. The power supply cord set is to be the main disconnected device.



WARNING

1. **FOR OUTDOOR USE:**
To reduce the risk of fire or electric shock, do not expose this apparatus to rain or moisture.
2. **UNDER WET LOCATION:**
Apparatus should not be exposed to dripping or splashing and no objects filled with liquids, such as vases should be placed on the apparatus.
3. **SERVICE INSTRUCTIONS:**
CAUTION - These servicing instructions are for use by qualified service personnel only. To reduce the risk of electric shock, do not perform any servicing other than that contained in the operating instructions unless you are qualified to do so.



 This symbol indicates that dangerous voltage constituting a risk of electric shock is present within this unit.

 This symbol indicates that there are important operating and maintenance instructions in the literature accompanying this unit.

FC & IC - ID

THIS DEVICE COMPLIES WITH PART15 OF THE FCC RULES AND RSS-123 ISSUE2 OF CANADA. OPERATION IS SUBJECT TO THE FOLLOWING TWO CONDITIONS:

- (1) This device may not cause interference.
- (2) This device must accept any interference, including interference that may cause undesired operation of the device. This equipment complies with FCC RF radiation exposure limits set forth for an uncontrolled environment.



"This product can only be used at the area that the altitude is lower than 2000m for safety purpose."



"This product can be used in non-tropical locations only for safety purpose."

Disposal Dispose of any unusable devices or batteries responsibly and in accordance with any applicable regulations.



2006-08-13

Disposing of used batteries with domestic waste is to be avoided!

Batteries / NiCad cells often contain heavy metals such as cadmium(Cd), mercury(Hg) and lead(Pb) that makes them unsuitable for disposal with domestic waste. You may return spent batteries/ accumulators free of charge to recycling centres or anywhere else batteries/accumulators are sold.

By doing so, you contribute to the conservation of our environment!

I. Part Names, Fig. 1

1. MA-100DB

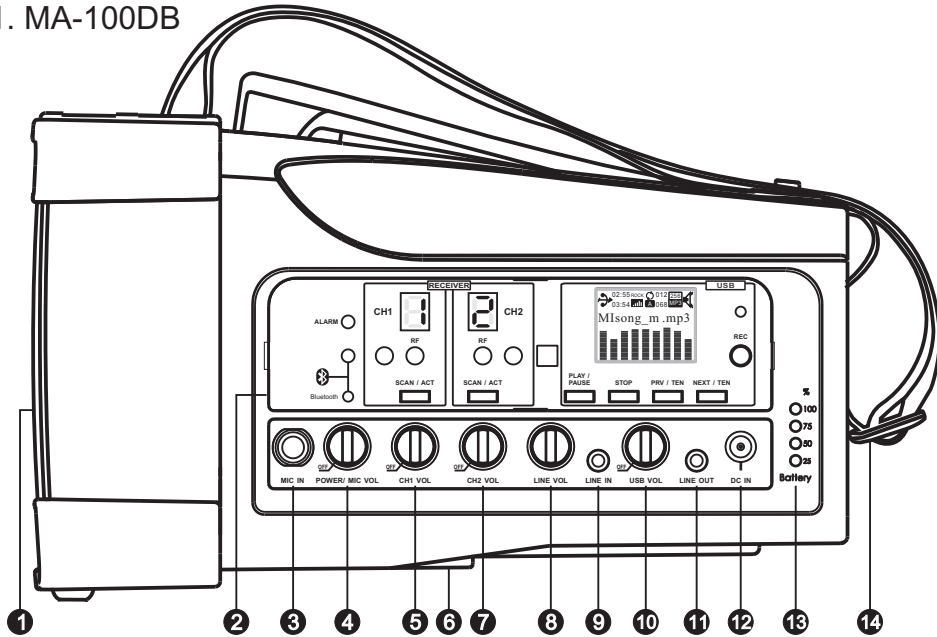

2. MA-100SB

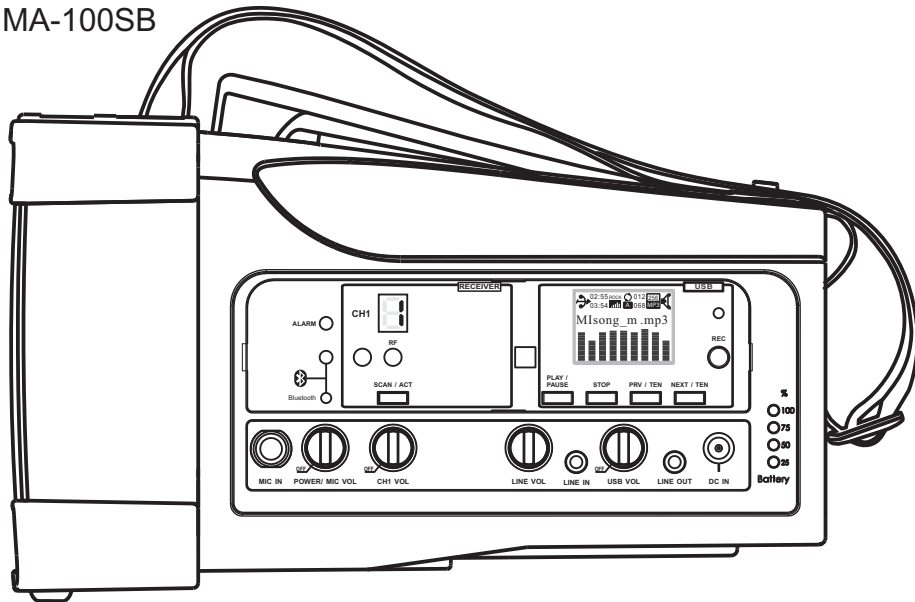

3. MA-100DG

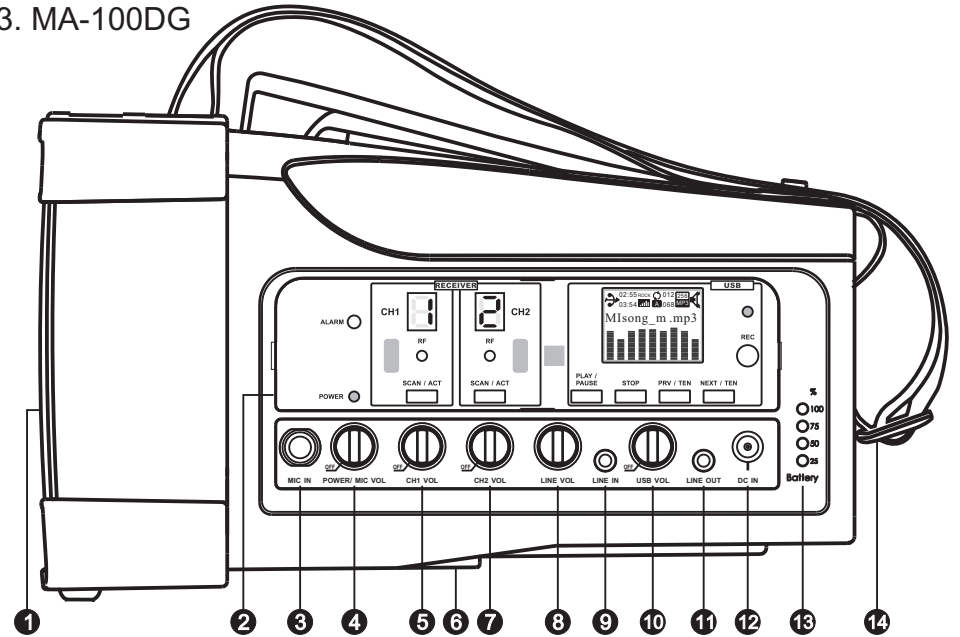

4. MA-100SG

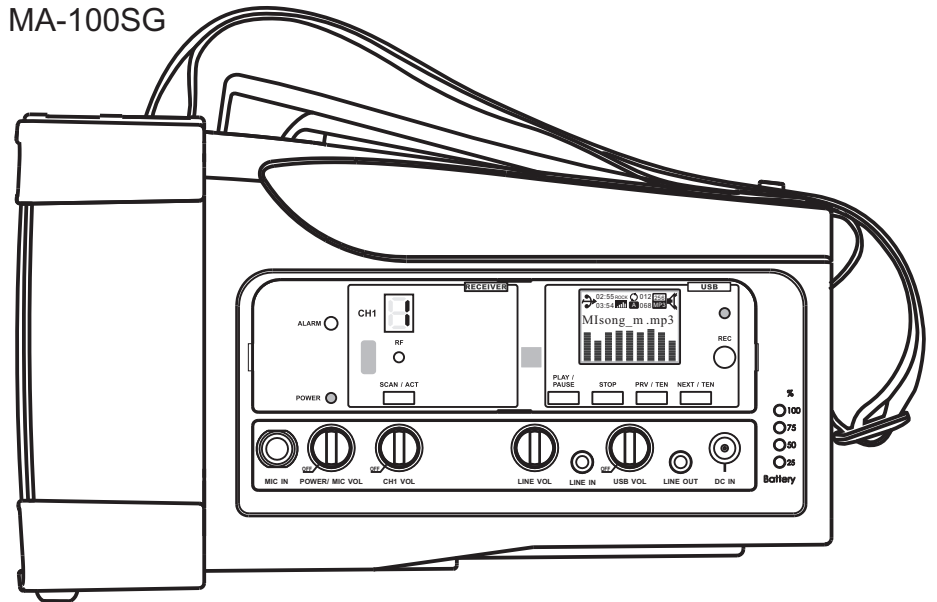

5. Exterior

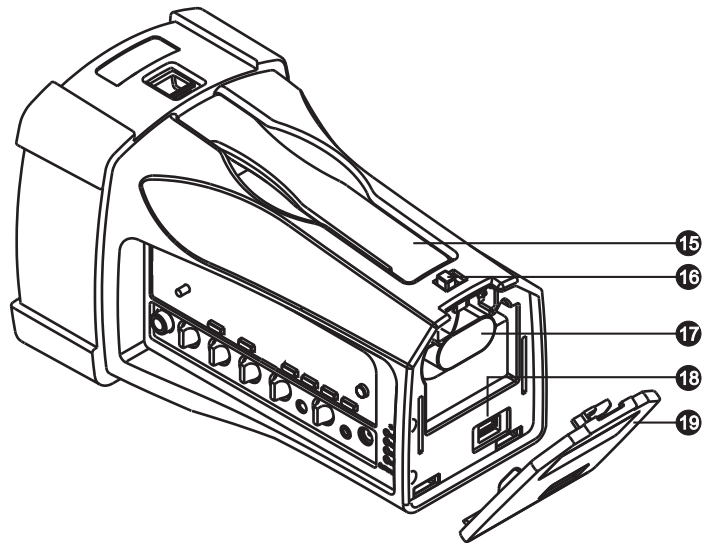

Fig. 1

- ❶ Speaker.
- ❷ Function Control Panel & Display.
- ❸ MIC IN: 6.3 Ø Wired Microphone Input.
- ❹ POWER/MIC VOL: Power/Volume Control.
- ❺ CH1 VOL: Channel 1 Wireless Mic Volume Control.
- ❻ Microphone Stand Adapter.
- ❼ CH2 VOL: Channel 2 Wireless Mic Volume Control.
- ❽ LINE VOL: Line Input Volume Control.
- ❾ LINE IN: 3.5 Ø Line Input Jack.
- ❿ USB VOL: USB Volume Control.
- ⓫ LINE OUT: Line Output Jack.

- ⓫ DC IN: DC Input Jack.
- ⓬ Battery Gauge & Battery Charging Indicator.
- ⓭ Adjustable Shoulder Belt.
- ⓮ Retractable Carry Handle.
- ⓯ Battery Cover release button.
- ⓰ Rechargeable Battery Compartment.
- ⓱ USB Player Slot.
- ⓲ Battery Compartment Cover.

II. Control Panel Part Names, Fig. 2

1. MA-100DB Dual-Channel

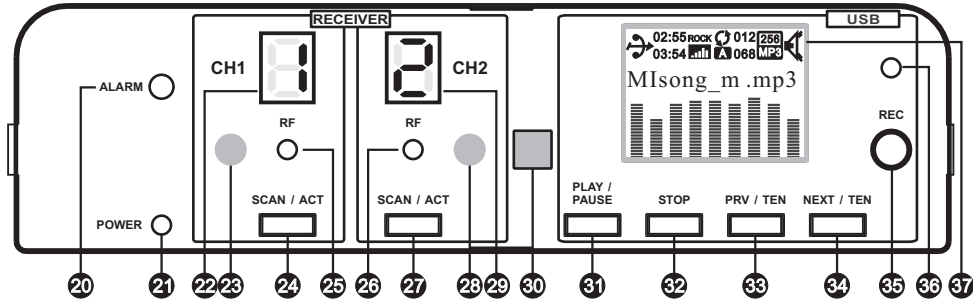

 38 MA-100DB/SB has Bluetooth version options

2. MA-100SB Single-Channel

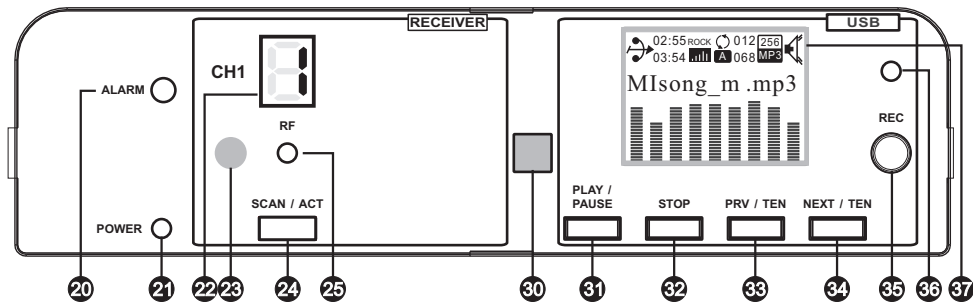

3. MA-100DG Dual-Channel

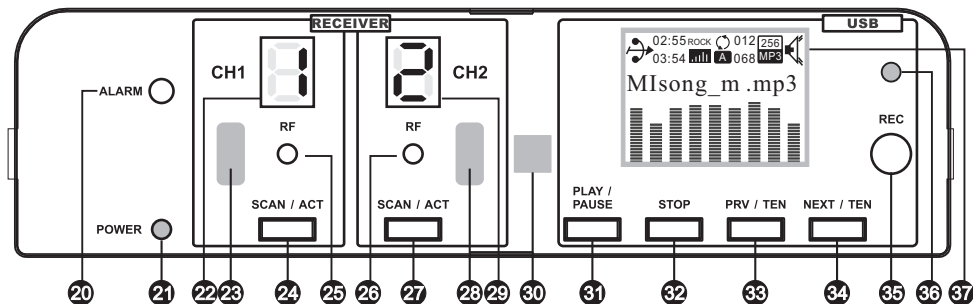

4. MA-100SG Single-Channel

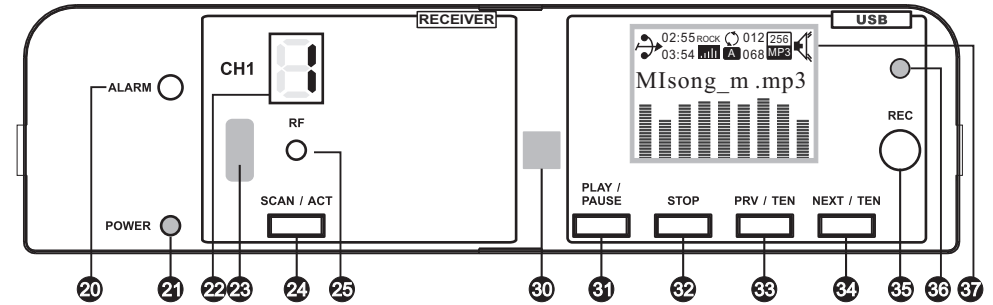

Fig. 2

- 20 ALARM: Alarm Siren Button.
- 21 Power Indicator.
- 22 Receiver 1 Channel Display.
- 23 Receiver 1 Infrared (IR) Sync Window.
- 24 Receiver 1 Channel Scan & Sync Button.
- 25 CH1 RF Indicator.
- 26 CH2 RF Indicator.
- 27 Receiver 2 Channel Scan & Sync Button.
- 28 Receiver 2 Infrared (IR) Sync Window.
- 29 Receiver 2 Channel Display.
- 30 USB Player Infrared (IR) Window.
- 31 PLAY/PAUSE Button.
- 32 STOP Button.
- 33 PRV/TEN: Previous/Previous Ten Button.
- 34 NEXT/TEN: Next/Next Ten Button.
- 35 Recording Button.
- 36 Recording Indicator.
- 37 USB Player Display.
- 38 Bluetooth Power & Indicator. (Optional)

III. Operating Instructions

1. Wired Microphones:

- (A) Turn on the Power/Volume Control ④ . Power Indicator glows red.
- (B) Plug the microphone into MIC IN ③ .
- (C) Adjust the Power/Volume Control ④ to desired volume.
- (D) Mic Volume Control and other audio inputs can be used concurrently.
- (E) To end the usage of wired microphones, turn off the Power/Volume Control ④ . Power Indicator ⑳ dims.

2. Wireless Microphones:

- (A) Turn on the Power/Volume Control ④ . Power Indicator glows red.
- (B) Turn on CH1 / CH2 Power and Volume Control ⑤ / ⑦ , CH1 / CH2 Indicator ㉒ / ㉓ glows red.
- (C) Power on CH1 / CH2 transmitter, RF Indicator ㉔ / ㉕ lights.
- (D) Adjust CH1 / CH2 Power and Volume Control ⑤ / ⑦ to desired volume.
- (E) Wireless Mic Volume Controls and other audio inputs can be used concurrently.
- (F) It is not possible to transmit two wireless microphones on the same channel to MA-100 system. Only one transmitter can be used at a time on that channel. Be sure to turn off one of the two transmitters to avoid interference. Same wireless microphone can transmit to multiple MA-100 systems on the same channel for a wider and expanded coverage.
- (G) To end the usage of wireless microphones, turn off the CH1 / CH2 Power and Volume Control and Power/Volume Control ④ . Power Indicator ㉑ dims.

3. Line-input:

- (A) Turn on the Power/Volume Control ④ . Power Indicator glows red.
- (B) Connect the external audio source to LINE IN jack ⑨ and adjust the audio source to adequate volume.
- (C) Adjust LINE VOL ⑧ to desired volume.

4. Line-output:

During power-on status, all mixed audio signal can be output via LINE OUT jack ⑪ .

5. USB Operating Instructions:

(A) Music Playback:

- (1) Turn on the Power/Volume Control ④ . Power Indicator glows red.
- (2) Turn on USB Volume Control ⑩ . LCD Screen ㉖ glows. Adjust the volume to adequate position.
- (3) Press PLAY/PAUSE Button ㉗ ㉘ to pause. Press it again for playback.
- (4) Press STOP Button ㉙ to stop playback. Press PLAY/PAUSE for playback.
- (5) Short press ㉚ ㉛ for the next track; long press to fast forward to the next ten tracks.
- (6) Short press ㉜ ㉝ for the last track; long press to fast backward to the last ten tracks.
- (7) To end the music playback, turn off USB Volume Control and Power/Volume Control.

(B) Record Tracks:

- (1) Insert a USB into USB Player Slot 18. Turn on Power/Volume Control 4 and USB Volume Control 10. LCD screen 37 glows and starts to play music.
- (2) Press STOP Button 32 or Recording Button 35 during playback will stop the playback. The screen shows STOP. Then press Recording Button and Recording Indicator 36 glows and is ready to record. Press PLAY/PAUSE Button to start recording and Recording Indicator blinks.
- (3) Press STOP Button to stop recording and turn the recorded file into MP3 format. The recorded file will play automatically after being saved.

(C) Two options for the order of playing music:

- (1) Copy the desired songs into USB storage unit one by one until copying all the desired songs. By this way, the play sequence will be based upon the order of music being programmed into USB storage unit.
- (2) Number the desired songs when copying them into folders. Then copy the folders into USB storage unit. Please note the songs must be numbered by the same digit like 00, 01, 02 or 000, 001, 002 or 0000, 0001, 0002.. and so on.

6. Bluetooth Connection:

Pair Bluetooth receiver with the mobile devices and play the music via the devices. (MA-100DB/SB has Bluetooth version options)

- (A) Turn on Power/Volume Control 4. Power Indicator 21 glows.
- (B) Activate the Bluetooth function on the mobile device and bring the device close to the MA-100.
- (C) Press & hold the Bluetooth Power & Indicator 33 for 3-5 seconds until blue/red light is flashing intermittently.
- (D) If indicator is not flashing intermittently or not flashing, repeat by press & hold for 3~5 seconds until blue/red indicator is flashing intermittently.
- (E) Enter "0000" when prompted to enter a PIN code.
- (F) Once paired and connection is made, the Bluetooth Indicator turns into blue and flashes intermittently.
- (G) To cancel Bluetooth function, press & hold Bluetooth Power & Indicator for 3 seconds.
- (H) Power off and on the Bluetooth receiver for changing connected device. Repeat the directions above to connect a different device. Blue/red light is flashing intermittently indicates the receiver is ready to be paired.

IV. Advanced Operating Instructions

1. Wireless Mic System:

(A) Channel Set-up:

- (1) To Scan for a Clear Receiver Channel: Press & hold the SCAN/ACT button  until current channel blinks. Release the button, blinks will last for 10 times and stop on the current channel. During blinking, press & release the SCAN/ACT button again and the receiver scans and sets at a clear channel automatically. Then the new channel will be stored, Fig. 3.

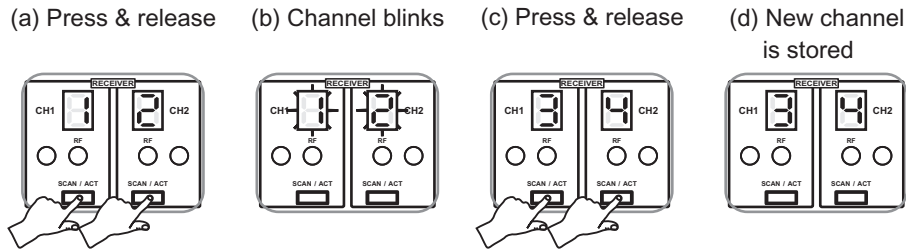

Fig. 3

- (2) Manually Forcing a Channel Change: Press & hold the SCAN/ACT button until current channel blinks. Release the SCAN/ACT button until a desired channel is reached. This will force the receiver to change to the next available clear channel, Fig. 4.

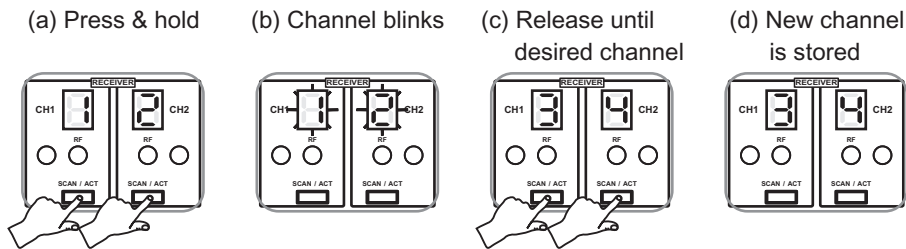

Fig. 4

(B) When to Change Channel:

- (1) Interference occurs during performance.
- (2) When two or more MA-100 systems need to be used at the same venue.

(C) Cautions:

- (1) Do not select a new channel while another system is operating as it may cause interference.
- (2) If “_” is displayed during channel scanning this indicates the current channel in this frequency band is experiencing interference. If problem persists, it is recommended to change and use a different frequency band.

(D) Corresponding Channel Display: MA-100 Receiver and Transmitter, Fig. 5:

MA-100	1	2	3	4	5	6	7	8	9	0	A	B	C	D	E	F
Transmitter LCD	01 01	01 02	01 03	01 04	01 05	01 06	01 07	01 08	01 09	01 10	01 11	01 12	01 13	01 14	01 15	01 16

MA-100 (2.4G)	1	2	3	4	5	6	7	8	9	0
Transmitter LCD	01 01	01 02	01 03	01 04	01 05	01 06	01 07	01 08	01 09	01 10

Fig. 5

- #### (E) MA-100DG/SG ID CODE set-up: ID CODE helps avoid the same channel interference from each other at the same venue. It is recommended where multiple channels are used concurrently. This system provides 16 ID codes (0, 1, 2, 3, 4, 5, 6, 7, 8, 9, A, B, C, D, E, F).

- (1) Press and hold SCAN button and concurrently, turn on the Power Switch. Release SCAN button when LED display glows to indicate ID CODE is activated. Press & release SCAN button once move one number up. Turn off the power to save the change when a number is selected.

- (2) Turn on the system power again and perform the ACT synchronization (refers to “ACT Synchronization (Sync) between Receiver and Transmitter Channels.”) to ensure transmitter and receiver ID CODE are synchronized and working properly.

(F) ACT Synchronization (Sync) between Receiver and Transmitter Channels, Fig. 6:

- (1) Press and release SCAN/ACT button, the current channel blinks and is ready for ACT synchronization.
- (2) Power on handheld or bodypack transmitter. Bring the transmitter sync port (red indicator) within 30 cm (12-inch) of CH 1 or CH 2 receiver sync port.
- (3) Once ACT synchronization is done, the channel screen will stop blinking and RF indicator glows green to indicate a successful RF link.
- (4) To cancel an accidental activation of ACT function, just press SCAN/ACT button again.

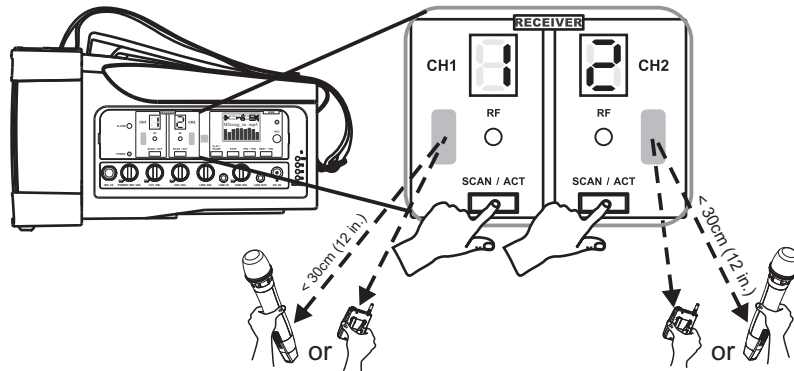

Fig. 6

(G) Cautions for MA-100DG/SG:

- (1) Position the MA-100DG/SG at least 5-meter away from WiFi, Bluetooth or other 2.4 GHz transmitting devices.
- (2) Line-of-sight between the transmitter and MA-100DG/SG provides the ideal reception range.
- (3) User can scan environment for WiFi devices with smartphone app, normally WiFi channel selections are 1, 6, 11.
 - (a) When there is WiFi channel selection 1, receiver channels can be set at 01 and 10 for non-interfering channels. Or select a lesser interference channels like 02, 03, 04, 05, 06, 07, 08, 09.
 - (b) When there is WiFi channel selection 6, receiver channels can be set at 01 and 11 for non-interfering channels. Or select a lesser interference channels like 02, 03, 04, 05, 06, 07.
 - (c) When there is WiFi channel selection 11, receiver channels can be set at 01 and 12 for non-interfering channels. Or select a lesser interference channels like 02, 03, 04, 05, 06, 07, 08, 09.

(4) Wi-Fi Channel Distribution, Fig. 7:

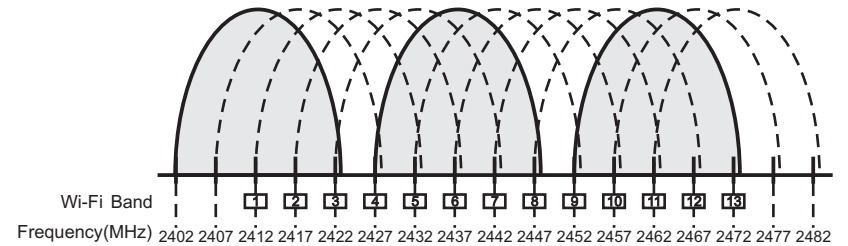

Fig. 7

2. Music Playback:

(A) USB Display Screen, Fig. 8:

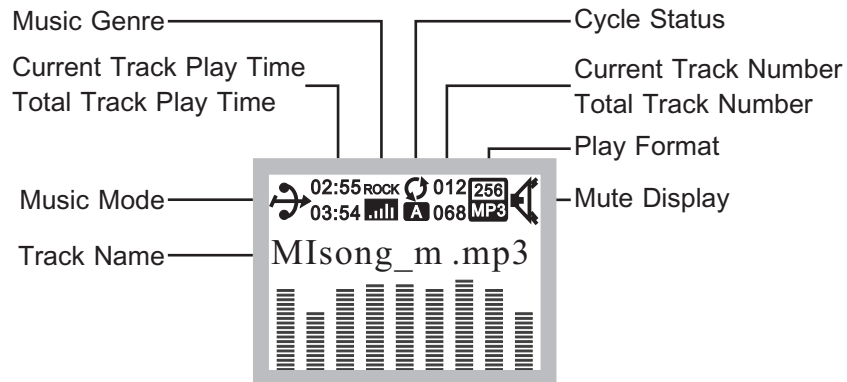

Fig. 8

(B) Press PLAY/PAUSE button to pause track, Fig. 9:

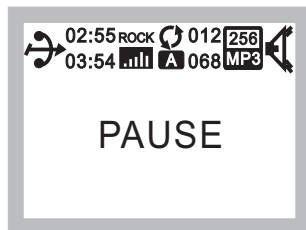

Fig. 9

(C) USB flash drive is not inserted, Fig. 10:



Fig. 10

(D) Panel Operating Instructions: During track playing, press & hold PLAY/PAUSE button to enter music parameter selection for changes. Press PLAY/PAUSE button and then press PRV/TEN or NEXT/ TEN to locate the desired parameter. Press PLAY/PAUSE to confirm change and save, Fig. 11.



Fig. 11

(E) Remote Operating Instructions: During track playing, press Mode button to enter music parameter selection for change. Press or to highlight selection. Press to confirm.

(F) Repeat Mode: Press PRV/TEN or NEXT/TEN to select parameter, Fig. 12.

- Repeat All:
- Repeat Folder:
- Repeat One:
- Random:

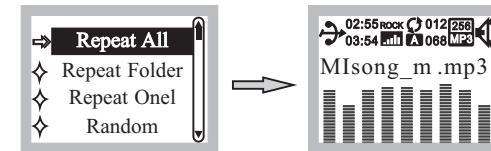

Fig. 12

(G) Equalizer Mode, Fig. 13:

- (1) Press PRV/TEN ◀◀ or NEXT/ TEN ▶▶ to select parameter.
- (2) Press PLAY/PAUSE ⏸ to confirm.
- (3)
 - NOR Natural: Normal → POP Pop: Popular → ROCK Rock: Rock →
 - JAZZ Jazz: Jazz → CLAS Classic: Classical → SOFT Soft: Soft →
 - DBB DBB: Deep Bass.

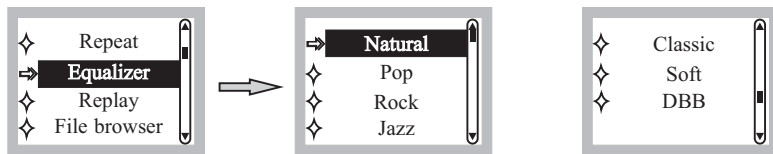

Fig. 13

(H) Replay Mode, Fig. 14:

- (1) Reply A- / -B mode.
- (2) In Replay Mode, press PLAY/PAUSE ⏸ to enter.
- (3) Press NEXT/TEN ▶▶ to select A- ; press NEXT/TEN ▶▶ again to select -B. Then it will replay A-B.
- (4) Press PLAY/PAUSE ⏸ to stop Replay Mode and return to playback mode.

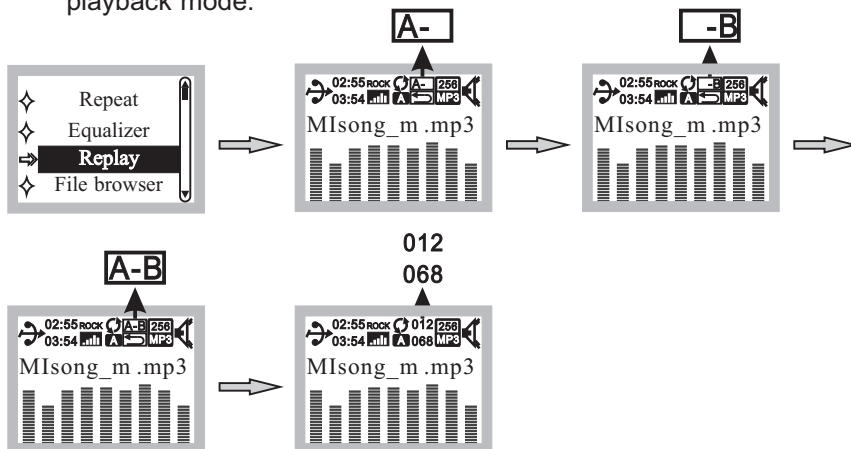

Fig. 14

- (I) File Browser Mode: Press PLAY/PAUSE ⏸ to enter track directory. Press PRV/TEN ◀◀ or NEXT/ TEN ▶▶ to select the desired song. Press PLAY/PAUSE to play the song tracks, Fig. 15.

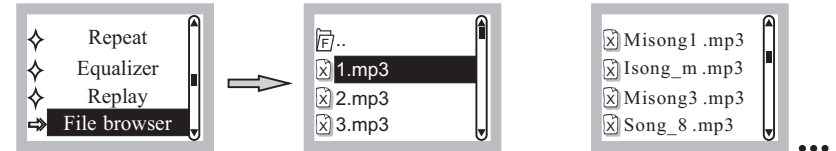

Fig. 15

- (J) Exit: In exit option, press PLAY/PAUSE ⏸ to return to the playback mode, Fig. 16.

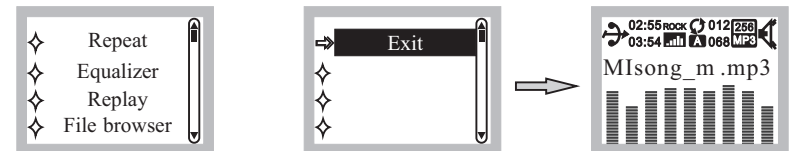

Fig. 16

- (K) Enter the Main Mode: USB flash drive not inserted or press & hold STOP button during playback.

- (1) Music Mode: Insert USB flash drive and press PLAY/PAUSE ⏸ to play music, Fig. 17.

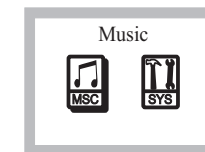

Fig. 17

- (2) System Settings Mode: Press PRV/TEN ◀◀ or the NEXT/TEN ▶▶ to change functions, press PLAY/PAUSE ▶▶ to confirm and enter system settings, Fig. 18.

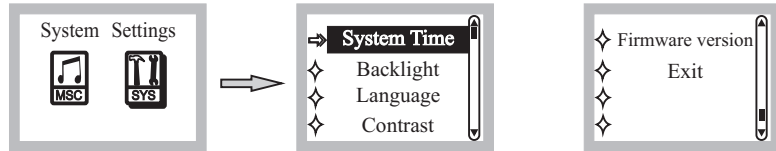

Fig. 18

- (3) Changing Date & Time: Press PLAY/PAUSE ▶▶ to enter the System Time setting mode, press PRV/TEN ◀◀ or NEXT/TEN ▶▶ to change. Press PLAY/PAUSE to confirm, Fig. 19.

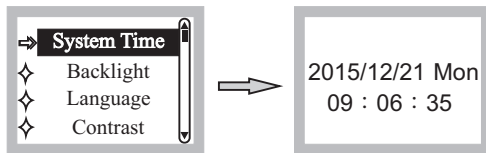

Fig. 19

- (4) Changing Backlight Brightness Time: 00 is constant. The parameter can be set by an interval of 10 seconds between 00 and 240, Fig. 20.

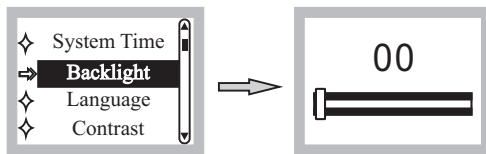

Fig. 20

- (5) Changing Language, Fig. 21.

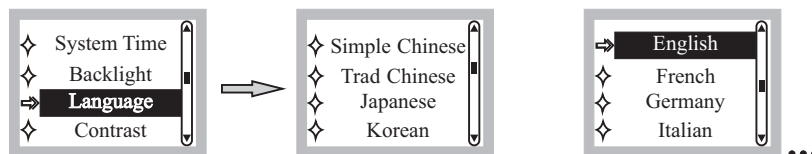

Fig. 21

- (6) Changing LCD Contrast, Fig. 22.

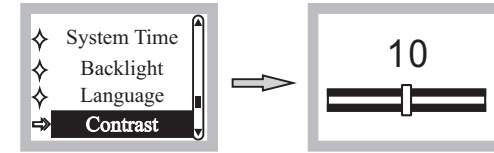

Fig. 22

- (7) Firmware Version, Fig. 23.

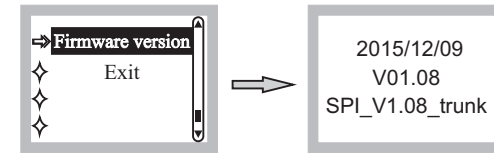

Fig. 23

- (8) Exit: Return to Music & System Settings (Main Mode), Fig. 24.

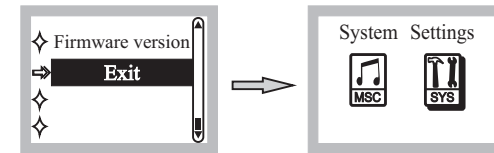

Fig. 24

- (L) Directory Selection:

- (1) File Browser: Press ▶▶ during playback and screen displays PAUSE. Press & hold ▶▶ to enter the directory option. Press ◀◀ or ▶▶ to sequentially select the directory option, Fig. 25.

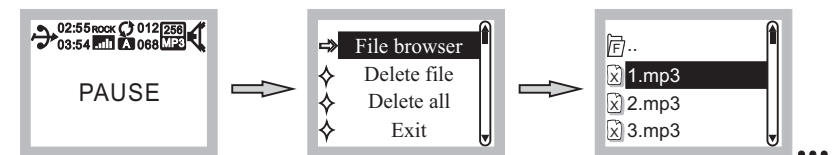

Fig. 25

- (2) Delete File: Press **▶||** to enter the “Delete file” screen. Press **◀◀** or **▶▶** to select “NO” or “YES”. Press **▶||** to confirm, Fig. 26.

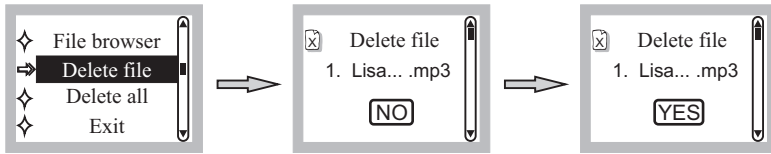

Fig. 26

- (3) Delete All: Press **▶||** to enter the “Delete all” screen. Press **◀◀** or **▶▶** to select “NO” or “YES”. Press **▶||** to confirm, Fig. 27.

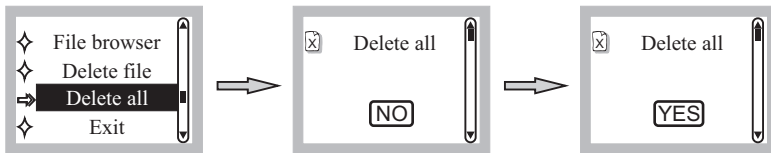

Fig. 27

- (4) Select “EXIT” to return to the PAUSE screen. Press **▶||** to return to playback mode.



Fig. 28

3. USB Remote Controls and Indicators, Fig. 29:

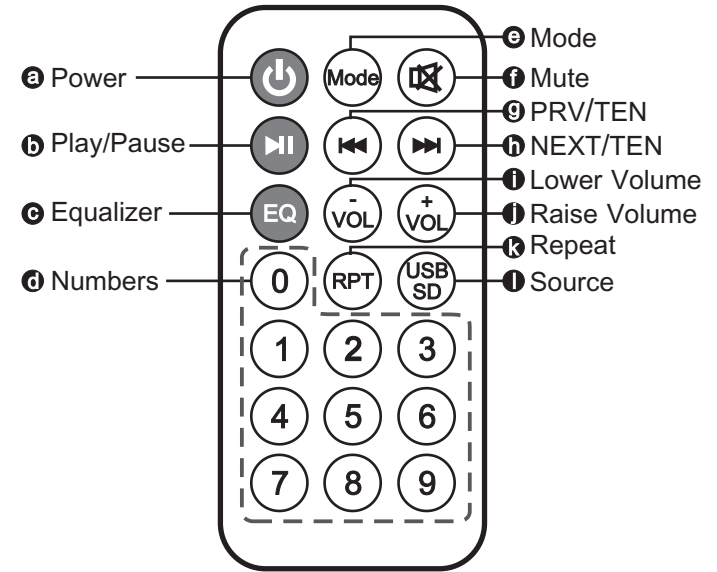

Fig. 29

4. Replacing USB Remote Battery, Fig. 30:

- (A) Press and hold the tenon on the bottom of the remote control and then slide out the battery tray.
- (B) Remove the old battery and insert the new battery in, making sure that the battery's positive (+) side is facing up.
- (C) Slide the battery tray back into the remote control until it clicks.
- (D) The remote control can function at distances of up to 5 meters. The remote control uses CR2032 lithium 3V coin battery.

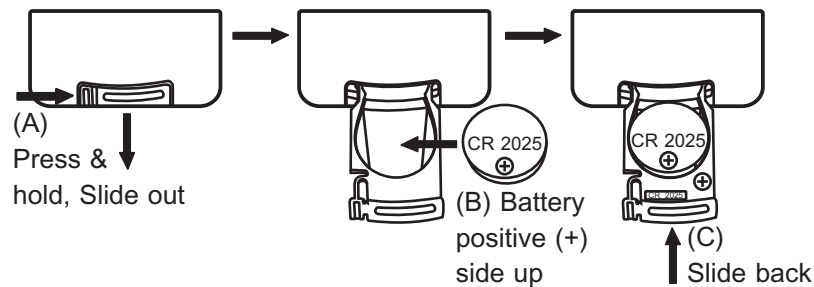

Fig. 30

V. Rechargeable Battery

1. Instruction of Charging the Rechargeable Battery.

- (A) Charge the battery completely in its first use to obtain its maximum capacity.
- (B) Connect to any available AC power outlet using the included DC adapter to the DC IN jack.
- (C) The Battery Charging Indicator **B** LED blinks while charging. Blinking LED may start later if the battery suffers from excessive battery drain. The battery may be damaged if the LED does not blink after charging for a while.
- (D) The battery is low when only the red LED is on. Please recharge the battery for at least 4 hours (the time of charging depends on the type of battery).
- (E) All LED blinking means the battery is charging. Charging completes when all LEDs glow.
- (F) Fully charge the battery for storage if it will not be used for an extended period of time. Battery may lose some capacity overtime. Over-discharged occurs and may damage the battery if not recharged for a long period of time. Thus, it is recommended to recharge often or every 3 months.
- (G) This device has 2 automatic power cut-off functions. Battery display will drop to red color for a period of time during low power status. Power will automatically shut-off to prevent battery operation. Recharge the battery immediately to avoid damage due to over-discharging.
- (H) Change to a new, fresh battery when battery hours are shortened after recharges due to battery aging.

- (I) All rechargeable batteries are consumables and have a limited lifespan, and eventually need to be replaced. A standard 14.8V lithium battery from MIPRO is recommended to ensure compatibility and performance.

2. Steps of Changing the Rechargeable Battery:

- (A) Lay the PA system on a flat surface. Remove the USB disk, Fig. 31.

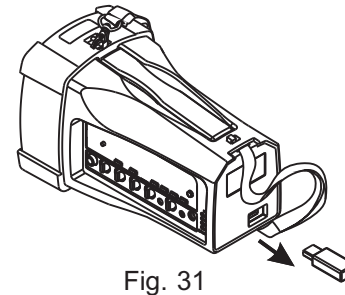

- (B) Remove the battery compartment cover by push latch to OPEN position, Fig. 32.

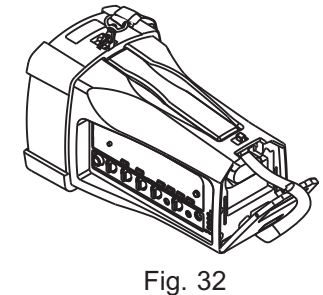

- (C) Pull out the battery gently and detach the connecting latch cable to remove the battery module, Fig. 33.

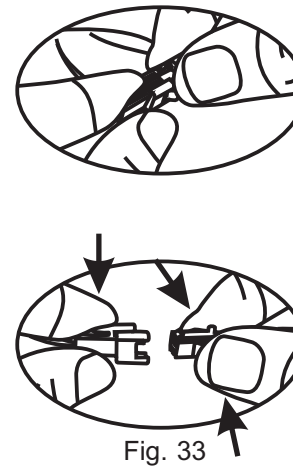

- (D) Remove and replace with a new battery module. Reconnect latch cable together and insert into the battery compartment, Fig. 34.

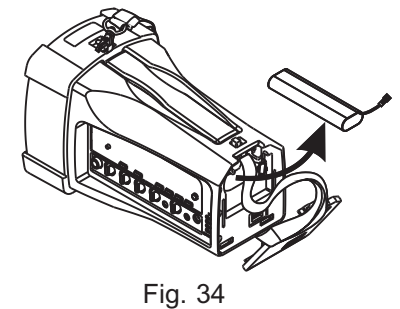

(E) Push latch to OPEN position and simultaneously align the shoulder belt between the groove of battery compartment cover, Fig. 35.

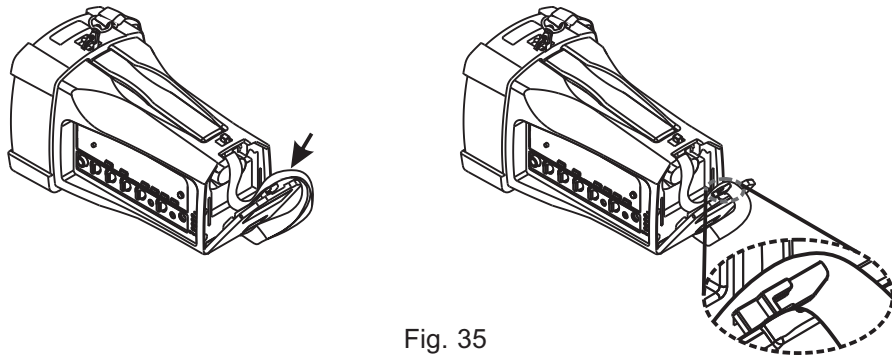

Fig. 35

(F) Push latch to OPEN position with left hand and simultaneously replace the battery cover into place with right hand. Push latch to left to close and for a secured lock, Fig. 36.

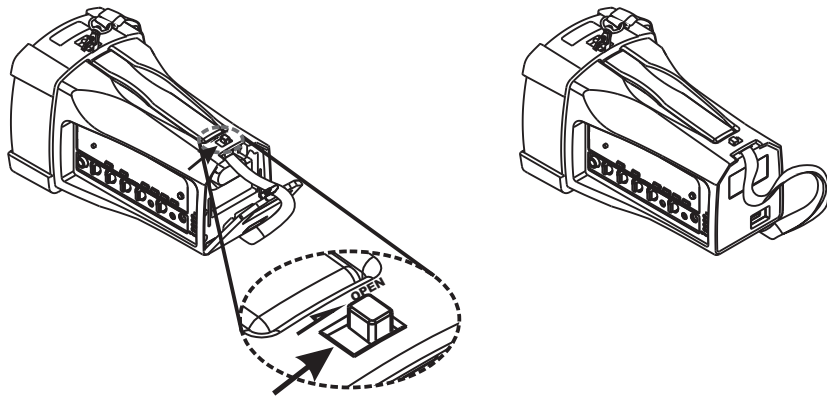

Fig. 36

VI. Connection to External Audio Sources, Fig. 37

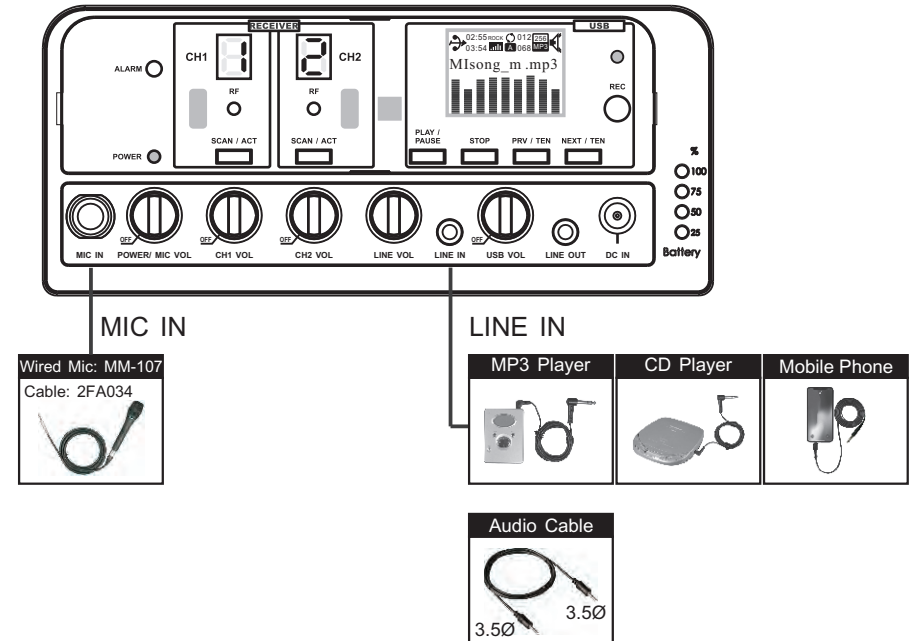

Fig. 37

VII. Adjustable Carry Handle, Fig. 38

1. Simply pull up the hidden carry handle for hand carry.
2. The adjustable, yet spring control enables spring fatigue.

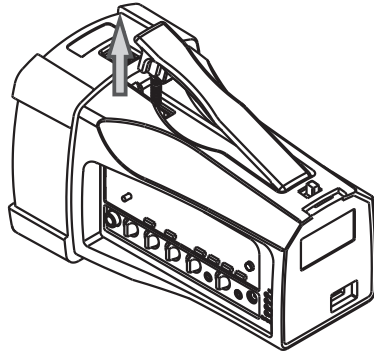

Fig. 38

VIII. Installation

Can be hand or shoulder carried and on a flat surface or microphone tripod.

IX. Note

1. Design and specifications are subject to change without prior notice. Refer to actual product in the event of product discrepancy.
2. Frequency range, output power and maximum deviation to adhere to local telecom regulations.