

IP REMOTE MICROPHONE**IP-A1RM**

Thank you for purchasing TOA's IP Remote Microphone.
Please carefully follow the instructions in this manual to ensure long, trouble-free use of your equipment.

TABLE OF CONTENTS

1. SAFETY PRECAUTIONS	3
2. GENERAL DESCRIPTION AND FEATURES	5
3. ABOUT SECURITY MEASURES	5
4. HANDLING PRECAUTIONS	5
5. SYSTEM EXAMPLES AND FUNCTION TABLE	6
5.1. Individual Broadcasts	6
5.2. Group Broadcasts	6
5.3. Function Table	6
6. DIMENSIONAL DRAWINGS	7
7. NOMENCLATURE AND FUNCTIONS	7
Operating Panel	7
Left Side	9
Bottom	9
8. LCD SCREEN AND TRANSITION	11
8.1. Transition	11
8.2. Home Screen	12
8.3. Settings Screen	17
9. OPERATION	20
9.1. Manual Broadcasting	20
9.2. Recording and Confirmation	21
9.3. How to Delete Recording Data	22
9.4. Speaker Volume Setting	23
10. INSTALLATION THE IP-A1RM ON A WALL	24
10.1. Changing the Orientation of the Microphone	24
10.2. Installing the Remote Microphone on a Wall	24
11. CONNECTIONS	25
11.1. Network Connection	25
11.2. AUX Input Connection	25
11.3. Connections to Control Input, Control Output, and Mute Terminals	26

12. SETTINGS	28
12.1. System Settings Summary	28
12.2. System Requirements	29
12.3. Connection with Browser	29
13. INITIALIZATION OF SETTINGS	30
14. CAUTIONS REGARDING THE AVC/H.264 PATENT LICENSE	31
15. OPEN SOURCE SOFTWARE	31
16. SPECIFICATIONS	31
Accessories	31
Optional product	31

1. SAFETY PRECAUTIONS

- Before installation or use, be sure to carefully read all the instructions in this section for correct and safe operation.
- Be sure to follow all the precautionary instructions in this section, which contain important warnings and/or cautions regarding safety.
- After reading, keep this manual handy for future reference.



WARNING

Indicates a potentially hazardous situation which, if mishandled, could result in death or serious personal injury.



CAUTION

Indicates a potentially hazardous situation which, if mishandled, could result in moderate or minor personal injury, and/or property damage.



WARNING

When Installing the Unit

- Do not expose the unit to rain or an environment where it may be splashed by water or other liquids, as doing so may result in fire or electric shock.
- Avoid installing or mounting the unit in unstable locations, such as on a rickety table or a slanted surface. Doing so may result in the unit falling down and causing personal injury and/or property damage.
- Since the unit is designed for indoor use, do not install it outdoors. If installed outdoors, the aging of parts causes the unit to fall off, resulting in personal injury. Also, when it gets wet with rain, there is a danger of electric shock.

When the Unit is in Use

- Should the following irregularity be found during use, immediately cut off the power supply from a PoE switching hub and contact your nearest TOA dealer. Make no further attempt to operate the unit in this condition as this may cause fire or electric shock.
 - If you detect smoke or a strange smell coming from the unit

- If water or any metallic object gets into the unit
- If the unit falls, or the unit case breaks
- If the LAN cable is damaged (exposure of the core, disconnection, etc.)
- If the speaker suddenly stops producing sound
- To prevent a fire or electric shock, never open nor remove the unit case as there are high voltage components inside the unit. Refer all servicing to qualified service personnel.
- Do not place cups, bowls, or other containers of liquid or metallic objects on top of the unit. If they accidentally spill into the unit, this may cause a fire or electric shock.
- Do not insert nor drop metallic objects or flammable materials in the ventilation slots of the unit's cover, as this may result in fire or electric shock.
- Do not touch the unit and LAN cable during thunder and lightning, as this may result in electric shock.
- To prevent the electromagnetic wave from badly influencing medical equipment, make sure to switch off the unit's power when placing it in close proximity to the medical equipment.

CAUTION

sunlight, near the heaters, or in locations generating sooty smoke or steam as doing otherwise may result in fire or electric shock.

When Installing the Unit

- Avoid installing the unit in humid or dusty locations, in locations exposed to the direct

FCC REQUIREMENTS

Note

This equipment has been tested and found to comply with the limits for a Class A digital device, pursuant to Part 15 of the FCC Rules. These limits are designed to provide reasonable protection against harmful interference when the equipment is operated in a commercial environment. This equipment generates, uses, and can radiate radio frequency energy and, if not installed and used in accordance with the instruction manual, may cause harmful interference to radio communications.

Operation of this equipment in a residential area is likely to cause harmful interference in which case the user will be required to correct the interference at his own expense.

Modifications

Any modifications made to this device that are not approved by TOA Corporation may void the authority granted to the user by the FCC to operate this equipment.

DECLARATION

Any modification to the unit, unless expressly approved by TOA Electronics, Inc., could void your authority to operate the equipment.

DECLARATION OF CONFORMITY

TOA Electronics, Inc.

1 Harmon Plaza, Suite 700 Secaucus, New Jersey 07094, USA

TEL 650-452-1200

declares under its sole responsibility that the product

IP REMOTE MICROPHONE IP-A1RM

complies with Part 15 of FCC Rules.

Operation is subject to the following conditions: (1) this device may not cause harmful interference, and (2) this device must accept any interference received, including interference that may cause undesired operation.

Warning: Operation of this equipment in a residential environment could cause radio interference.

This equipment is not suitable for use in locations where children may be present.

2. GENERAL DESCRIPTION and FEATURES

The IP-A1RM is an IP Remote Microphone that is designated to make audio broadcasts to IP-A1 series receiving devices via network.

- Power is supplied by way of PoE (IEEE 802.3af) switching hubs.
- The IP Remote Microphone supports the following broadcasting functions:

Microphone broadcasting	Realtime broadcasts of microphone audio.
Recorded audio broadcasting	Microphone audio is temporarily prerecorded, allowing broadcast contents to be confirmed before actual broadcast.
AUX broadcasting	A microphone or other external sound source device can be connected to the AUX input jack for broadcast.
Built-In sound source broadcasting (Pattern Broadcasting)	Playback patterns can be created for later broadcast, using as many as 20 built-in sound source files. Broadcasts can be started and ended by key operation. Additionally, the Scheduler function, control input or Remote API (HTTP) can be enabled as events.

- By setting the scheduler function on the WEB browser, it can easily create chimes, background music, and event action programs.
- Orders of priority can be set among the various sound source, meaning higher priority broadcasts can interrupt and override lower priority broadcasts.
- The Remote Microphone also features a built-in speaker for easy confirmation of recorded microphone audio, playback of internal sound source files, or monitoring of broadcast audio while in progress.
- The command list function can be used to send multiple HTTP commands at once.
- Connected external equipment can be controlled by control outputs in synchronization with broadcasting.

3. ABOUT SECURITY MEASURES

- Ensure that sufficient security measures are taken on the customer's own responsibility.
- TOA Corporation takes no responsibility for damage or loss caused by security-related problems, such as illegal access.
- To help prevent illegal access to the unit, be sure to change the user ID and password from those used for initial setup.
For setting methods and other details, please refer to the separate transmitting device setup manual which can be downloaded from the TOA DATA Library (<https://www.toa-products.com/international/>).
- Take utmost care in the management of the unit's communications password.

4. HANDLING PRECAUTIONS

- Please apply the latest firmware version to this product. The latest version is available at the TOA DATA Library (<https://www.toa-products.com/international/>).
- As this product is IP-based, a slight time lag between actual and broadcast may happen.
- Broadcast audio may sometimes break up due to packet loss or network failure.
- Periodic inspection and manual rebooting are needed to extend the product life.
- This product may reboot automatically to keep the stable operation.

5. SYSTEM EXAMPLES AND FUNCTION TABLE

5.1. Individual Broadcasts

Individual SIP broadcasts to a single IP audio device can be performed through the P2P connection (servers can also be connected).

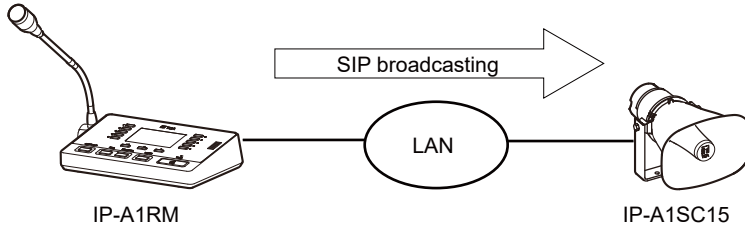

5.2. Group Broadcasts

Group broadcasts to multiple IP audio devices can be performed by way of multicast audio transmission.

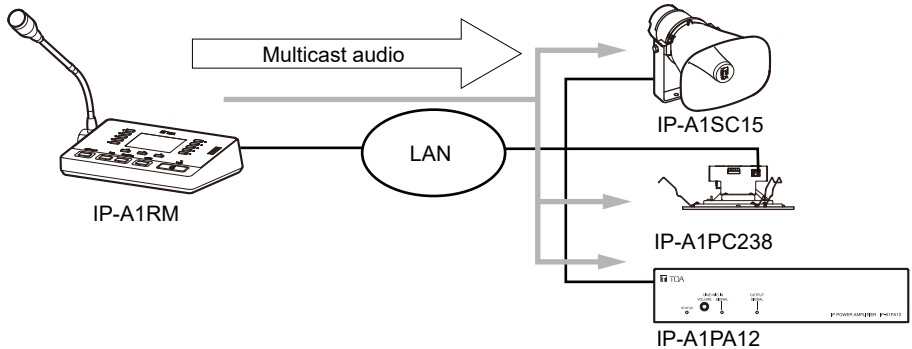

5.3. Function Table

Action	Event trigger				Broadcast destination	
	Key operation	Control input	Scheduler	Remote API	Individual broadcasts (SIP)	Group broadcasts (Multicast)
Microphone broadcast	✓	—	—	✓	✓	✓
Recorded audio broadcast	✓	—*1	—*1	—*1	✓	✓
AUX broadcast	✓	✓	✓	✓	✓	✓
Pattern broadcast (Internal sound source file)	✓	✓	✓	✓	✓	✓
Command transmission	✓	✓	✓	✓	—	—
Control output	✓	—*2	✓	✓	—	—

*1 Recorded audio files can be used in pattern broadcasts by assigning them to patterns.

*2 By using the control input to execute broadcast functions, control inputs can be output as broadcast conditions.

6. DIMENSIONAL DRAWINGS

[Operating Panel]

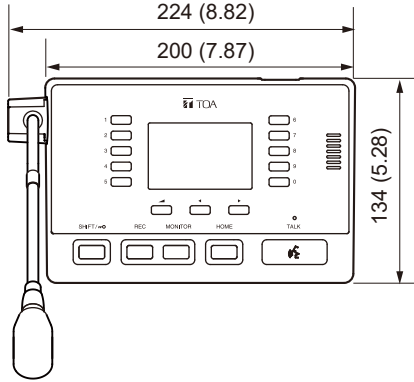

[Left Side]

Unit: mm (in)

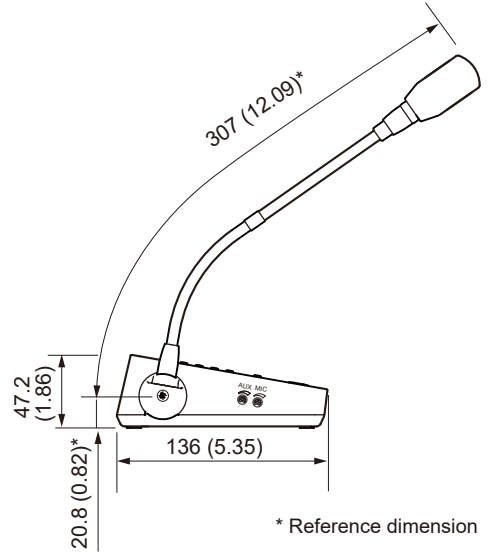

7. NOMENCLATURE AND FUNCTIONS

[Operating Panel]

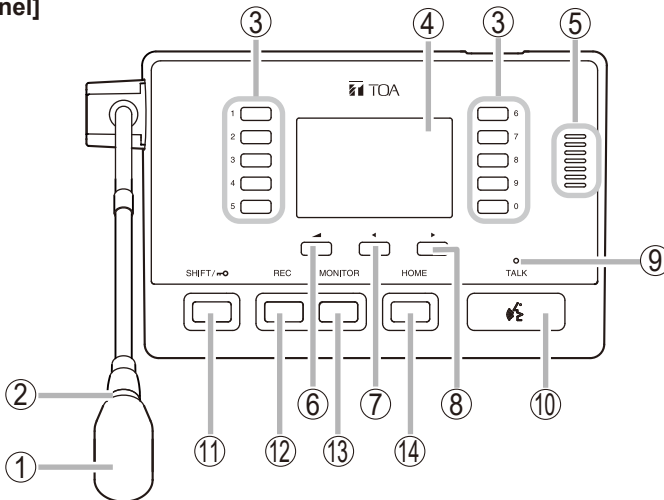

1. Microphone

Speak into this microphone when performing microphone broadcasts or recording microphone broadcasts.

2. Microphone indicator (blue)

Lights when the microphone (1) is enabled. The microphone (1) can be spoken into when this indicator is lit.

3. Selection keys (0 – 9)

These keys can be selected to execute the functions assigned to them in the key settings. Key numbers correspond to the numbers shown on the LCD screen (4). Changing the screen page makes it possible to assign different functions.



4. LCD screen

Displays key names or Remote Microphone operating conditions. For further details, please refer to "Transition" on p. 11.

5. Monitor speaker

Allows monitoring of broadcast audio or confirmation of recorded audio during microphone recordings or built-in audio playback.

6. key (Volume key)

Displays monitor speaker (5) output volume at the bottom of the LCD screen (4) when pressed. Output volume can be changed using the  and  keys (7 & 8). Press the Volume key again to return to the previous screen mode. Also used to perform the operation displayed at the bottom of the LCD screen (4).



7. key

Press this key to move to the previous page from the current page displayed on the LCD screen (4). Also used to perform the operation displayed at the bottom of the LCD screen (4) or to move the cursor visible on the screen to the left.

8. key

Press this key to move to the next page from the current page displayed on the LCD screen (4). Also used to perform the operation displayed at the bottom of the LCD screen (4) or to move the cursor visible on the screen to the right.

9. Status indicator (green, blue, yellow, red)

Indicates the unit's operating status.

Unit Operation	Status Indicator
System startup	Flashing green
Broadcast standby	Continuously lit green
Broadcasting	Continuously lit blue
System mute*	Flashing red
Initialization or firmware updating	Continuously lit yellow

* "System mute" represents the state that the broadcast audio sent out from the transmitting device is suspended and at the same time, IP speakers in the same network are muted by the signal from the transmitting device. "System mute" is activated by mute terminal or control input terminal.

10. Broadcast key

Starts or stops the broadcast selected with a Selection key (3).

11. Shift key/Keylock key

Used to display the function menu (VOLUME, REC MENU, SETTING) at the bottom of LCD screen (4). Press the home key (14) to return to the home screen.



The Keylock function can be enabled or disabled by holding down this key for 1 second or more at the Home screen. A key symbol appears on the screen while the Keylock function is enabled.

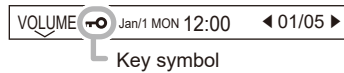

12. Recording key

Holding down this key for 1 or more seconds enables microphone (1) recording. Up to 2 minutes of microphone audio can also be temporarily recorded while this key is held down. Recording stops when the key is released. The microphone symbol appears on the screen during microphone recording.

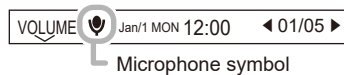

13. Monitor key

Normally, recorded audio is checked by holding down this key and playing it back

through the monitor speaker (5). Playback stops when the key is released. When a Selection key (3) preset for execution of pattern broadcast is pressed, pattern audio is played back through the monitor speaker (5).

When a Selection key (3) preset for execution of AUX broadcast is pressed, audio input to the AUX input jack (23) is played back through the monitor speaker (5).

The speaker symbol appears during audio playback after the depression of this key.

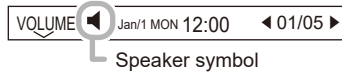

14. Home key

Returns the LCD screen (4) display to the home screen.

[Left Side]

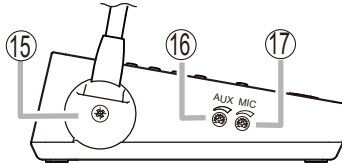

15. Microphone fixing cover

A cover to fix the microphone. For wall hanging installation, remove this cover and change the orientation of the microphone. (See "Changing the orientation of the microphone" on p. 24.)

Note

Use an appropriately sized screwdriver to adjust the volume. Do not push too hard when rotating the screwdriver. Pushing too hard may damage the volume control.

16. AUX volume control

Adjusts the sound volume of the audio input from the AUX input jack (24). Use the DIP switch (29) to match the output volume for each connected device, and make fine volume level adjustments using this volume control. Adjust the volume while listening to the output from the monitor speaker (5).

17. Microphone volume control

Adjusts the output volume of the microphone (1). Use the Recording function or the like to make adjustments while listening to the output from the monitor speaker (5).

Note

Use an appropriately sized screwdriver to adjust the volume. Do not push too hard when rotating the screwdriver. Pushing too hard may damage the volume control.

[Bottom]

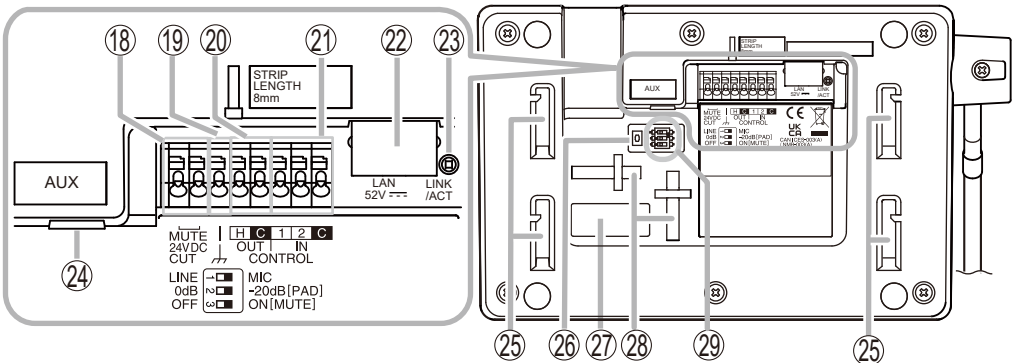

18. Mute terminal (24 V DC CUT)

By the control signal of cutting 24 V DC, this unit is in the "System mute" state. "System mute" means the audio transmission from this unit is forcibly disabled, and this

unit sends mute control signal to mute IP speakers in the same network segment. When using this terminal, turn on the Mute switch of DIP switch (29).

19. Functional ground terminals

Hum noise may be generated when external equipment is connected to the unit. Connecting this terminal to the functional ground terminal of the external equipment may reduce the hum noise.

Note

This terminal is not for protective ground.

20. Control output terminal

Allows control of external equipment in synchronization with the unit operation.

21. Control input terminals

Allows input of control signals from connected external equipment to enable actions set in the Event settings.

22. LAN port

Connect to a PoE switching hub using a LAN cable.

23. LINK/ACT indicator (green)

Flashes when data is being sent or received over a network.

24. AUX input jack

Connect an audio source device or microphone to this jack.
Use a $\varnothing 3.5$ mm miniplug for connection. Input audio is sent out to the network under external control. Set the DIP switch (29) to roughly match the output level of the connected device.

25. Wall mounting bracket mounting holes

Used when installing the IP-A1RM on the wall in conjunction with the optional wall mounting bracket. (See "Installing the remote microphone on a Wall" on p. 24.)

26. Reset key

The unit begins to restart when this key is clicked.

Hold down this key until the Status indicator (9) lights yellow to initialize the unit's settings.

27. Name label

Product number, product name, manufacturer name, and other information are listed.

28. Wiring cable fixing holes

Used to bind the wiring cables. (See "Connections to Control Input, Control Output, and Mute Terminals" on p. 26.)

29. DIP switch

• Line/Mic switch (Switch 1)

Set this switch to MIC when connecting a microphone, and to LINE when connecting a general sound source device to AUX input jack (24).

Default setting: LINE

• PAD switch (Switch 2)

When the input level to AUX input jack (24) is high, set the PAD to 20 dB.

Default setting: 0 dB

• Mute switch (Switch 3)

When using Mute terminal (18), set this switch to on.

Default setting: OFF

Note

Do not set this switch when nothing is connected to the Mute terminal (18). It will be recognized as control signal mute enable (24 V DC cut) and will mute the system.

8. LCD SCREEN AND TRANSITION

8.1. Transition

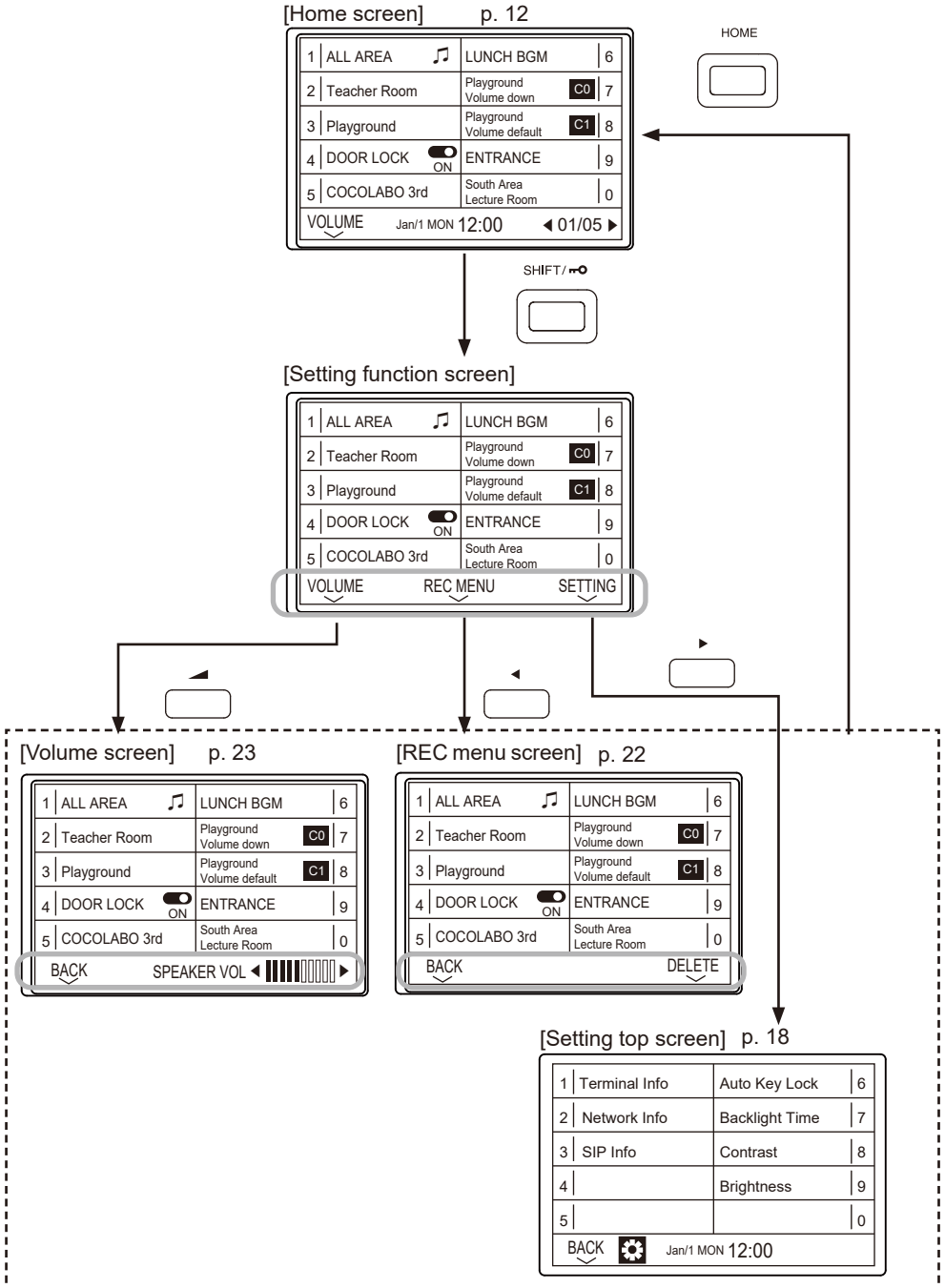

8.2. Home Screen

Normally, the Home screen is displayed. Pressing the Home key reverts the display to the Home screen.

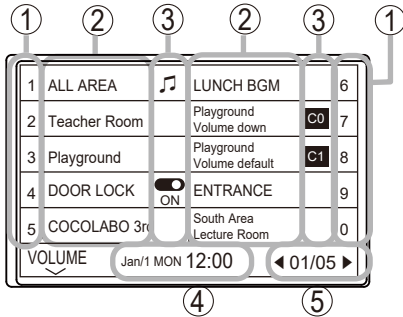

	Appears next to the key that has the chime enabled. The chime will sound when the key is pressed to make a broadcast.
 	Appears next to the key that has the control output enabled. The current control output status is displayed.
	Appears next to the key for which the corresponding command is set. The command set number is also displayed.

(1) Selection key number

Displays the corresponding number of the pressed Selection key.

(2) Key name

Displays the names assigned to the Selection keys.

One-line display: 16 characters

Two-line display: 16 characters × 2 lines

(3) Icon

Displays the icon for the function set to each key.

(4) Current day and time

The current day/date and time is displayed when the IP Remote Microphone is in standby mode.

(5) Page number

Shows the number of the page displayed. The page being displayed can be switched using the ◀ or ▶ keys.

8.2.1. Operating status display

The IP Remote Microphone's currently operating background status is displayed at the bottom of the LCD screen, depending on triggers other than key operations.

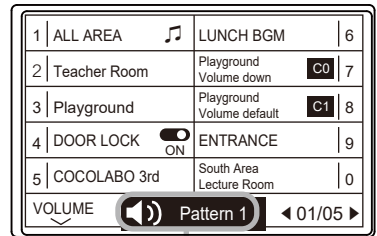

(6)

(6) Operating status display section

The display appears as shown below to indicate the operating status.

Display	Operating Status	Operation
AUX Broadcasting	AUX broadcasting in progress	AUX audio broadcast.
Pattern 1	Pattern (built-in audio) broadcast in progress	Pattern broadcast. Displays the pattern name while in progress.
Broadcast Disable	Broadcast Disable	Broadcast stopped by event.
System Mute	System mute	System muted by event.

8.2.2. Manual broadcasting screen

Pressing a Selection key that has been set for manual broadcasting displays the manual broadcasting screen. Press the key again to return to the Home screen.

[When manual broadcasting is selected]

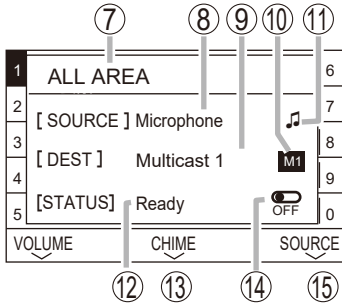

[During manual broadcasting]

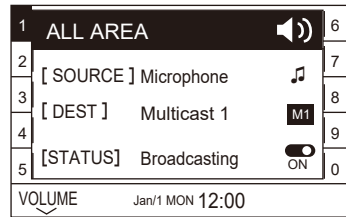

(7) Key name

Displays the names assigned to the Selection keys. Executing manual broadcasting inverts the screen colors and displays the speaker symbol. A maximum of 32 characters can be displayed.

(8) Selected audio source display

Displays the selected audio source.

(9) Broadcast destination display

Displays information about the preset broadcast destination. If multicast, the broadcast destination group name is displayed. If SIP, the broadcast destination's SIP ID or IP address is displayed.

(10) Broadcast destination icon

The following icons are displayed according to the broadcast destination:

	"M1" or some other multicast channel number, is displayed if the broadcast destination is Multicast.
	"SIP" is displayed if the broadcast destination is SIP.

(11) Chime icon

A chime is sounded whenever this icon appears.

(12) Status display

Indicates whether or not the selected broadcast can be executed when the Remote Microphone is broadcasting in the background. "Busy" is displayed whenever a higher priority broadcast is in progress, and "Ready" is displayed whenever the unit

is in standby mode or when a lower priority broadcast is in progress.

(13) Chime selector

Chime operation (before and after a broadcast) can be enabled or disabled by pressing the ◀ key. The chime can also be temporarily switched ON or OFF regardless of whether or not the chime has been enabled in the key settings.

(14) Control output status display

When the control output is initiated in conjunction with a broadcast, the current control output can be checked to confirm that it is ON or OFF. If linked to the broadcast, the display turns on with the start of the broadcast.

(15) Audio source selection

The selected audio source display (8) switches in the following order with each depression of the ▶ key. Select the sound source to be used for manual broadcasting.



MIC: The microphone is selected and broadcasts are made using microphone audio.

REC: Recorded audio is selected and broadcasts are made using recorded audio.

AUX: AUX is selected and broadcasts are made using audio input to the AUX jack.

8.2.3. Pattern broadcast screen

Pressing a Selection key for which pattern broadcasting has been set displays the pattern broadcast screen. Press the key again to return to the Home screen.

[When pattern broadcasting is selected]

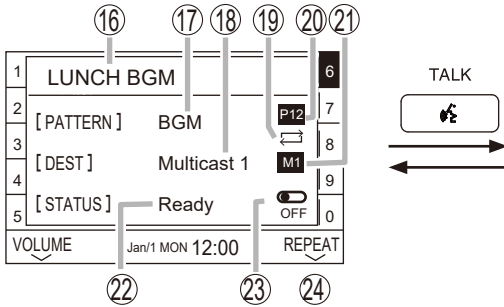

[During pattern broadcasting]

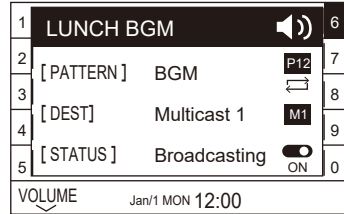

(16) Key name

Displays the names assigned to the Selection keys. When pattern broadcasting is enabled, the color is inverted and the speaker symbol is displayed. A maximum of 32 characters can be displayed.

(17) Pattern name

Displays the name of the set pattern.

(18) Broadcast destination display

Displays information about the preset broadcast destination. If multicast, the broadcast destination group name is displayed. If SIP, the broadcast destination's SIP ID or IP address is displayed.

(19) Repeat icon

Appears if in repeat broadcast mode.

(20) Pattern number icon

Displays the set pattern number as an icon.

(21) Broadcast destination icon

The following icons are displayed according to the broadcast destination:

M1	"M1" or some other multicast channel number, is displayed if the broadcast destination is Multicast.
SIP	"SIP" is displayed if the broadcast destination is SIP.

(22) Status display

Indicates whether or not the selected broadcast can be executed when the IP Remote Microphone is broadcasting in the background. "Busy" is displayed whenever a higher priority broadcast is in progress, and "Ready" is displayed whenever the unit is in standby mode or when a lower priority broadcast is in progress.

(23) Control output status display

When the control output is initiated in conjunction with a broadcast, the current control output can be checked to confirm that it is ON or OFF. If linked to the broadcast, the display turns on with the start of the broadcast.

(24) Repeat switching

Pressing the ► key changes the repeat method. The broadcast is repeated continuously from start to end, regardless of the pattern's set number of repetitions or the repetition period.

8.2.4. SIP status display screen

Displays the SIP status display screen whenever a SIP call is disconnected or cannot be started. Pressing the ► key or Home key returns the display to the home screen. For details about the SIP status display, please refer to the separate transmitting device setup manual.

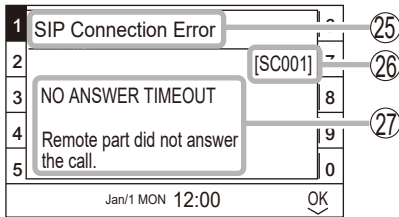

(25) SIP status name

Displays SIP status.

(26) SIP status code

Displays the code number of the current SIP status.

(27) SIP status display

Displays descriptions of SIP status.

8.2.5. Command transmission screen

Pressing a Selection key that has been set for command transmission displays the command transmission screen. Press the key again to return to the Home screen.

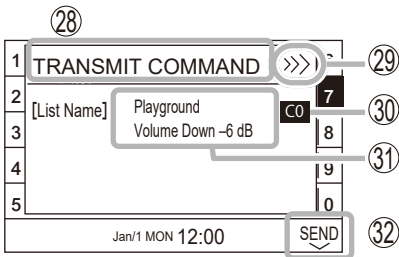

(28) Key name

Displays the names assigned to the Selection keys. A maximum of 32 characters can be displayed.

(29) Command transmission icon

This icon is displayed whenever a command is being transmitted. The display reverts to the home screen after 5 seconds.

(30) Command list number icon

Displays the icon assigned to the number set in the command list.

(31) Command list name

Displays the name set in the command list.

(32) Command transmission

Pressing the ► key executes the command transmission.

8.2.6. Control output screen

Pressing a Selection key that has been set for control output displays the control output screen. Press the key again to return to the Home screen.

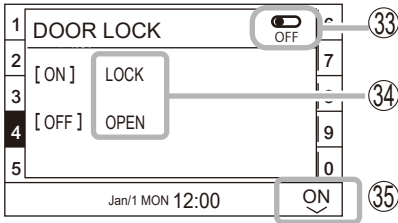

(33) Control output status display

The current control output can be checked to see whether it is enabled or not. The display changes in tandem with the status, whether ON or OFF.

(34) Text display

Displays optional text regarding whether the set status is ON or OFF. A maximum of 32 characters can be displayed.

(35) ON/OFF selection

Turns the control output ON or OFF, each time the ► key is pressed.

8.3. Settings Screen

8.3.1. How to enter settings screen

Step 1. Press the Shift key on the home screen.

Step 2. Press the ► key.
"SETTING" is selected.
The Setting top screen is displaced.

[Home screen]

1	ALL AREA	♪	LUNCH BGM	6
2	Teacher Room		Playground Volume down	C0 7
3	Playground		Playground Volume default	C1 8
4	DOOR LOCK	ON	ENTRANCE	9
5	COCOLABO 3rd		South Area Lecture Room	0
VOLUME Jan/1 MON 12:00 ◀ 01/05 ▶				



[Setting function screen]

1	ALL AREA	♪	LUNCH BGM	6
2	Teacher Room		Playground Volume down	C0 7
3	Playground		Playground Volume default	C1 8
4	DOOR LOCK	ON	ENTRANCE	9
5	COCOLABO 3rd		South Area Lecture Room	0
VOLUME REC MENU SETTING				



[Setting top screen]

1	Terminal Info		Auto Key Lock	6
2	Network Info		Backlight Time	7
3	SIP Info		Contrast	8
4			Brightness	9
5				0
BACK ⚙ Jan/1 MON 12:00				

8.3.2. Setting top screen

Pressing a Selection key displays its corresponding Settings screen.

Use the ◀ or ▶ keys to adjust the Auto Key Lock (6), Backlight Time (7), Contrast (8) and Brightness (9). Use the ▲ key to return to the top screen.

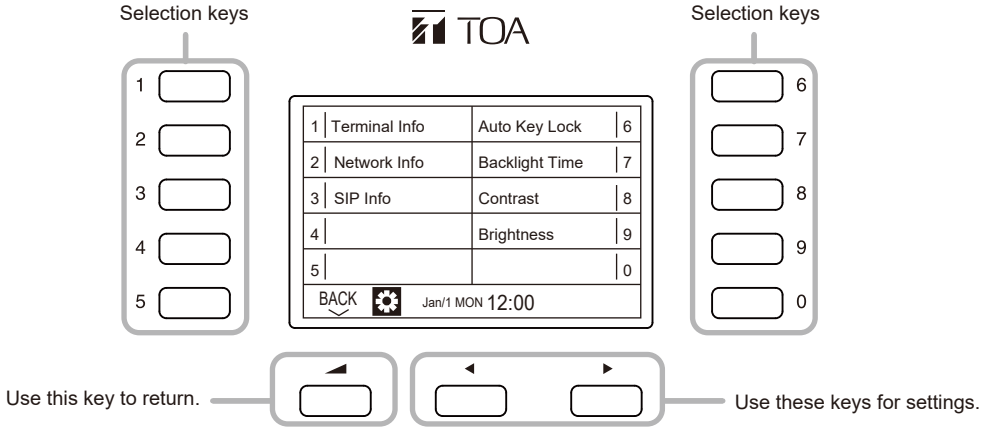

(1) Terminal info

Allows the Remote Microphone's Terminal information to be checked.

Terminal Info	
Terminal Name	IP-A1RM
Firmware Version	3.0.0
MAC Address	00-05-F9-00-00-00

BACK  Jan/1 MON 12:00

(2) Network info

Allows the Remote Microphone's Network information to be checked.

Network Info	
IP Address	192.168.14.1
Subnet Mask	255.255.255.0
Default Gateway	0.0.0.0
Primary DNS Server	0.0.0.0
Secondary DNS Server	0.0.0.0

BACK  Jan/1 MON 12:00

(3) SIP info

Allows the Remote Microphone's SIP information to be checked.

SIP Info	
Account	OFF
Status	Unregistered
Server	0.0.0.0
User ID	

BACK  Jan/1 MON 12:00

(6) Auto key lock

The Keylock function automatically activates if no operation is performed during a set time interval.

Auto Key Lock			
1 min	2 min	3 min	
5 min	10 min	15 min	◀ Never ▶

BACK  Jan/1 MON 12:00

(7) Turn off backlight

The backlight automatically turns OFF if no operation is performed during a set time interval.

Time to Turn Off Backlight				
Always	30 sec	1 min	2 min	◀ 3 min ▶
	5 min	10 min	15 min	Never

BACK  Jan/1 MON 12:00

(8) Contrast

Adjusts the contrast of the LCD screen.

Contrast	
◀  ▶	

BACK  Jan/1 MON 12:00

(9) Brightness

Adjusts the brightness of the LCD screen.

Brightness	
◀  ▶	

BACK  Jan/1 MON 12:00

9. OPERATION

9.1. Manual Broadcasting

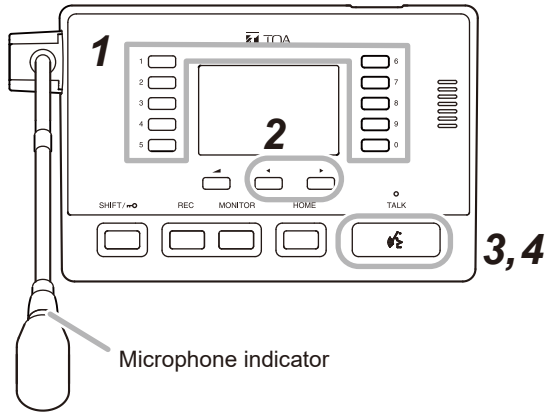

Step 1. Press the Selection key.

Pressing a Selection key that has been set for manual broadcasting displays the following screens.

1	ALL AREA	6
2	[SOURCE] Microphone	7
3	[DEST] Multicast 1	8
4	[STATUS] Ready	9
5		0
	VOLUME CHIME SOURCE	

Step 2. Select the audio source to be broadcast.

The audio source display changes with each depression of the ► key. Select the audio source to be broadcast.



Tip

The audio source can be selected if multiple audio sources are enabled in the key settings menu performed using a PC browser.

Step 3. Press the broadcast key.

Broadcasting begins.

If the microphone is selected as the audio source, the microphone indicator will light blue, indicating that the microphone can be used.

Step 4. Press the broadcast key again.

The broadcast ends and the LCD screen returns to the home screen.

9.2. Recording and Confirmation

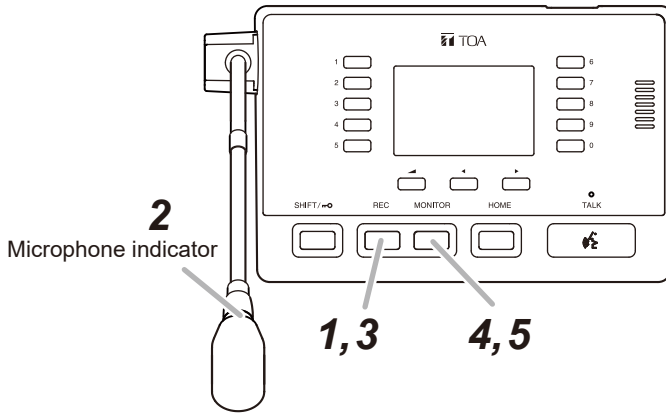

[Recording]

- Step 1.** Hold down the Recording key.
Pressing this key for about 1 sec. turns ON the microphone recording status and changes the display as shown at right.
- The Recording screen is displayed.
 - The microphone symbol is displayed at the bottom of the LCD screen.
 - The microphone indicator lights, indicating that the recording is started.
 - The remaining recording time starts counting down from 2 minutes.

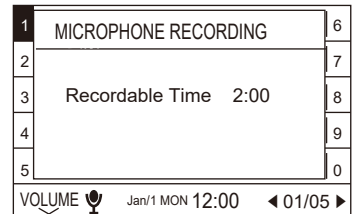

- Step 2.** Speak into the microphone if microphone recording is enabled.
The voice is recorded as long as the Recording key is pressed.

- Step 3.** Release the Recording key to end the recording.
The recording screen, microphone icon and microphone indicator will all extinguish when the recording is terminated.

[Confirmation]

- Step 4.** Hold down the Monitor key.
Recorded audio is played back while the Monitor key is held down.
- The speaker icon is displayed at the bottom of the LCD screen.
 - Recorded audio is played back and can be heard via the Monitor speaker.
- Step 5.** Release the Monitor key to terminate playback.
The recorded audio playback stops and the speaker icon disappears.

9.3. How to Delete Recording Data

Step 1. Press the Shift key.
Displays "REC MENU" at the bottom of the LCD screen.

Step 2. Press the ◀ key.
"REC MENU" is selected.

Step 3. Press the ▶ key.
"DELETE" is selected.

Step 4. Press the ▶ key.
"OK" is selected and deleted a temporary recording file.

Step 5. Press the Home key.
The display returns to the home screen.

Tip

Press the ◀ key, the display returns to the home screen.

1	ALL AREA	♪	LUNCH BGM	6
2	Teacher Room		Playground Volume down	C0 7
3	Playground		Playground Volume default	C1 8
4	DOOR LOCK	ON	ENTRANCE	9
5	COCOLABO 3rd		South Area Lecture Room	0
VOLUME Jan/1 MON 12:00 ◀ 01/05 ▶				

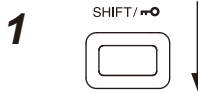

1	ALL AREA	♪	LUNCH BGM	6
2	Teacher Room		Playground Volume down	C0 7
3	Playground		Playground Volume default	C1 8
4	DOOR LOCK	ON	ENTRANCE	9
5	COCOLABO 3rd		South Area Lecture Room	0
VOLUME REC MENU SETTING				



1	ALL AREA	♪	LUNCH BGM	6
2	Teacher Room		Playground Volume down	C0 7
3	Playground		Playground Volume default	C1 8
4	DOOR LOCK	ON	ENTRANCE	9
5	COCOLABO 3rd		South Area Lecture Room	0
BACK DELETE				



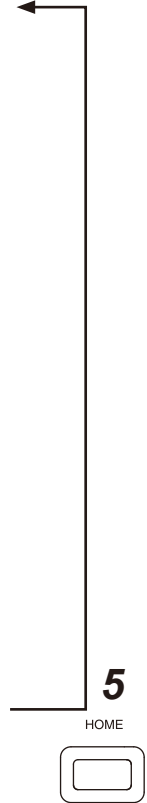

1	DELETE RECORDING FILE	6
2		7
3	Delete a temporary recording file.	8
4	Sure to delete?	9
5		0
CANCEL Jan/1 MON 12:00 OK		



9.4. Speaker Volume Setting

Step 1. Press the  key on the home screen.

Displays "VOLUME" at the bottom of the LCD screen.

Step 2. Press the  or  key, adjusts the output volume of the monitor speaker.

Step 3. Press the  key.

"BACK" is selected.







The display returns to the home screen.

Tip







Press the home key, the display returns to the home screen.

Tip

The volume level can also be changed on the Setting function screen that appears when the function key is pressed.

1	ALL AREA 	LUNCH BGM	6
2	Teacher Room	Playground Volume down 	7
3	Playground	Playground Volume default 	8
4	DOOR LOCK 	ENTRANCE	9
5	COCOLABO 3rd	South Area Lecture Room	0
VOLUME 		Jan/1 MON 12:00	 01/05 



1	ALL AREA 	LUNCH BGM	6
2	Teacher Room	Playground Volume down 	7
3	Playground	Playground Volume default 	8
4	DOOR LOCK 	ENTRANCE	9
5	COCOLABO 3rd	South Area Lecture Room	0
BACK 		SPEAKER VOL 	

10. INSTALLATION THE IP-A1RM ON A WALL

The IP-A1RM IP Remote Microphone can be mounted on wall surfaces if fitted with the optional WB-RM500 Wall Mounting Bracket.

10.1. Changing the Orientation of the Microphone

The IP-A1RM's microphone is installed in the orientation shown on the right figure by default. When mounting the IP-A1RM on the wall, change the orientation of the microphone following the procedure below.

Step 1. Remove 2 screws securing the microphone, then detach the microphone fixing cover.

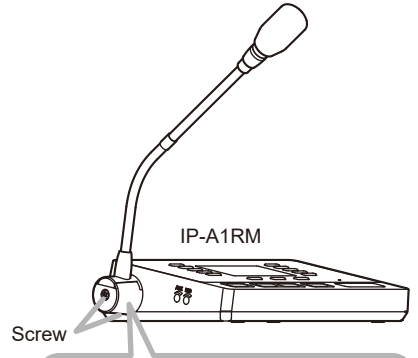

Step 2. Rotate the microphone 90° as shown below.

Note

The microphone can be fixed only at the specified angle.

Be careful not to pinch the cable when rotating it to avoid damage to the cable.

Doing otherwise may result in malfunction.

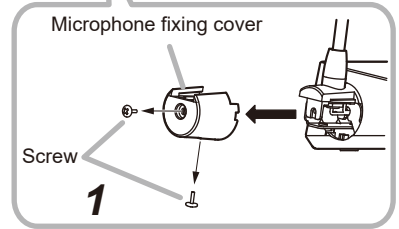

Step 3. Attach the microphone fixing cover so that it fits in place to fix the microphone, then secure the cover with 2 screws removed in **Step 1**.

Notes

- Be sure to install the screws ① first, then ② in the figure.

- When securing the cover, be sure to check the screw holes and tighten the screws correctly.

Step 4. Change the direction of the microphone for an appropriate position.

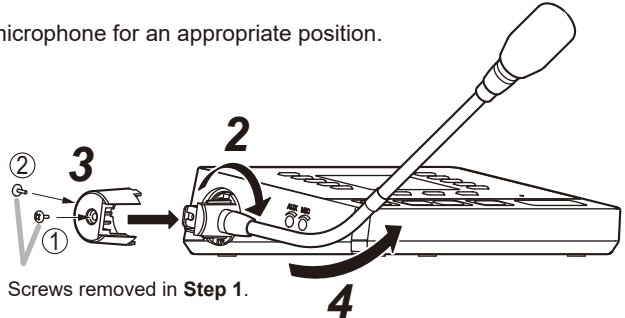

Screws removed in **Step 1**.

10.2. Installing the Remote Microphone on a Wall

Hang the remote microphone onto the WB-RM500 mounted on the wall.

For details, refer to the installation manual supplied with the WB-RM500.

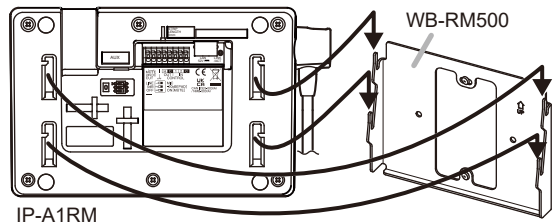

11. CONNECTIONS

11.1. Network Connection

Connect the IP-A1RM to the PoE switching hub using a LAN cable (straight UTP or STP cable, both rated at Category 5). Power is supplied by the PoE switching hub.

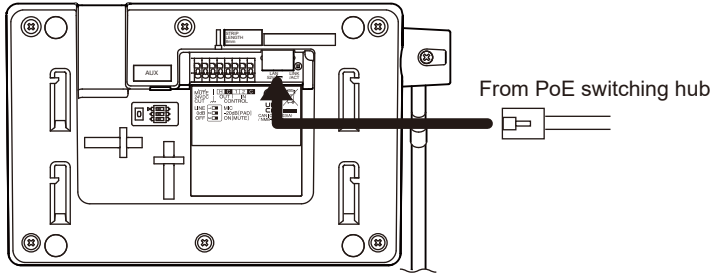

Compatible switching hubs: Switching hubs conforming to PoE (IEEE802.3af Class 3) specifications

11.2. AUX Input Connection

To connect an external sound device, plug a ø3.5 mm miniplug from the device directly into the AUX input jack. Set the DIP switch to roughly match the output level of the sound device being connected.

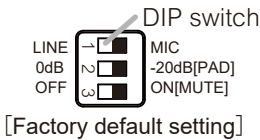

Devices that can be connected to the AUX input jack	DIP switch (1 and 2) setting	
Line output audio source devices		1: LINE 2: 0 dB [PAD]
Dynamic microphone		1: MIC 2: 0 dB [PAD]
PC or audio player earphone output		1: MIC 2: -20 dB [PAD]

Note

Ensure that the power supply is turned OFF before changing DIP switch settings.

11.2.1. AUX volume control adjustment

Set the DIP switch to roughly match the output of the connected device, then use the AUX volume control on the left-side panel for fine volume level adjustment.

Note

Use an appropriately sized screwdriver to adjust the volume. Do not push too hard when rotating the screwdriver. Pushing too hard may damage the volume control.

11.3. Connections to Control Input, Control Output, and Mute Terminals

Connect the external device control lines to the press-fit control input, control output or mute terminal. Referring to the strip gauge located on the bottom surface of the unit, strip the wire ends and connect the wires. Either AWG 24 – 14 ($\varnothing 0.5 - 1.6\text{mm}$) solid wire or $0.2 - 2.0\text{mm}^2$ stranded wire may be used.

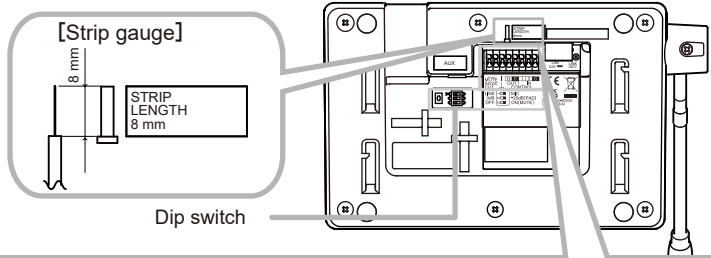

From external control device's control input terminals

From external control device's 24 V DC cut output terminal.

From external control device's control output terminals

Tip
Set Mute switch (Switch 3 of the DIP switch) ON to enable the Mute function.

LINE		MIC
0dB		-20dB[PAD]
OFF		ON[MUTE]

DIP switch

[Control output (1 channel)]
Open collector output
Withstand voltage: 30 V DC
Allowable current: 150 mA or less

[Control input (2 channels)]
No-voltage make contact input
Open circuit voltage: 5 V DC
Short-circuit current: 2 mA or less

Secure the cables to the IP-A1RM's bottom surface as shown below so that the IP-A1RM will not be pushed up by the cables.

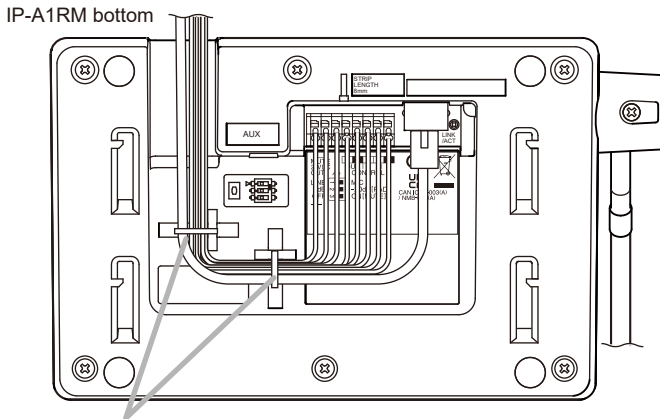

Bundle the cables and secure them to the fixing holes for wiring with the zip ties supplied with the IP-A1RM.

The following functions can be assigned to the control input and control output terminals by browser settings:

Terminals	Assignable Functions
Control input terminals	<ul style="list-style-type: none"> • Internal sound source broadcasting (Pattern) • AUX input broadcasting • Command set execution • Broadcast disable (Stop audio streaming) • System mute (Stop audio streaming and Mute other IP speakers)
Control output terminal	<ul style="list-style-type: none"> • Control output performed using the selection keys. • Control output performed by the Scheduler's Date and Time control. • Output during manual broadcasts (assigned to the manual broadcast key). • Output during microphone broadcasts • Output during AUX broadcasts • Output during built-in audio broadcasts

For settings, please refer to the separate transmitting device setup manual.

The latest version of the setup manual is available on the TOA DATA Library (<https://www.toa-products.com/international/>).

12. SETTINGS

12.1. System Settings Summary

The following settings can be performed using a PC browser connected to the same network as the IP paging gateway.

Setting Name	Setting Item
Scheduler	Registration, editing, and deletion of programmed repeat broadcast schedules and event actions, display of schedules for one week, check the annual schedule
Status	Confirmation of current firmware version, network settings, volume setting
Key Settings	Settings of the function to be assigned to a Selection key
Network	Network settings such as the IP address
SIP	Settings of SIP connection enable/disable, SIP server address, authentication information, and audio codec
Destination	Settings of multicast destination group name, multicast address and port number
Audio	Settings of Line/Mic input sensitivity and mute
Media	Uploading/downloading or deletion of sound source files such as messages to or from the internal memory
Chime	Settings of the chime output before and after broadcasts
Pattern	Registration of sound source playback to be associated with events as patterns
Event	Settings of operations to be synchronized with the control input and control output
Priority	Settings of priority order for broadcast audio sources; microphone, recorded audio, internal sound source, and AUX input
Command List	Settings of HTTP commands in command sets
User	Changing username and password
Maintenance	Download and upload the configuration file, initialization, firmware update, hardware reboot, and downloading action logs
System	Date and time settings, NTP server settings, language selection, time zone settings

For more information, please refer to the separate transmitting device setup manual. The latest version of the setup manual is available on the TOA DATA Library (<https://www.toa-products.com/international/>).

12.2. System Requirements

Connectable system requirements are as follows:

Display	Resolution: 1920 × 1080 or greater
OS	Windows 10 Pro (64-bit), Windows 10 Home (64-bit), Windows 11 Pro, Windows 11 Home
Browser	Microsoft Edge, Google Chrome

Notes

- Windows and Microsoft Edge are registered trademarks of Microsoft Corporation of the United States in the United States and other countries.
- Google Chrome is a trademark of Google LLC of the United States in the United States and other countries.

12.3. Connection with Browser

12.3.1. Connection presets

The IP Remote Microphone is factory-preset as follows:

Username: admin
Password: guest
IP address: 192.168.14.1
Subnet mask: 255.255.255.0
Default gateway: 0.0.0.0

Before connecting a PC to the IP Remote Microphone and changing its setting, it will be necessary to set the PC's network settings so that it can operate on the same network as the IP Remote Microphone. Take care that no IP addresses are duplicated in the same network.

For example, if the IP Remote Microphone's IP address is 192.168.14.1, set the PC's IP address to 192.168.14.10.

12.3.2. Making connection

Notes

- Avoid simultaneously connecting to the IP Remote Microphone from multiple PCs.
- Avoid simultaneously connecting to the IP Remote Microphone from a single PC using multiple browsers.

Step 1. Start the browser and enter the speaker's IP address in the address field.
The Login screen is displayed.

Step 2. Enter the username and password, and click the LOGIN button.
The Status screen is displayed, enabling a range of settings.

Note

For details regarding the setting method, please refer to the separate transmitting device setup manual.

The latest version of the setup manual is available on the TOA DATA Library (<https://www.toa-products.com/international/>).

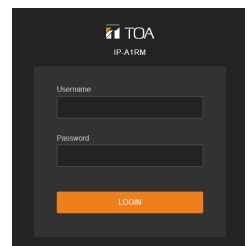

13. INITIALIZATION OF SETTINGS

Follow the procedure below to return all unit settings to their default.

Tip

When initialized with the reset key, the unit's sound source files are left in "Media," not deleted. Initialization to factory defaults, including deletion of sound source files, should be performed using the browser settings menu.

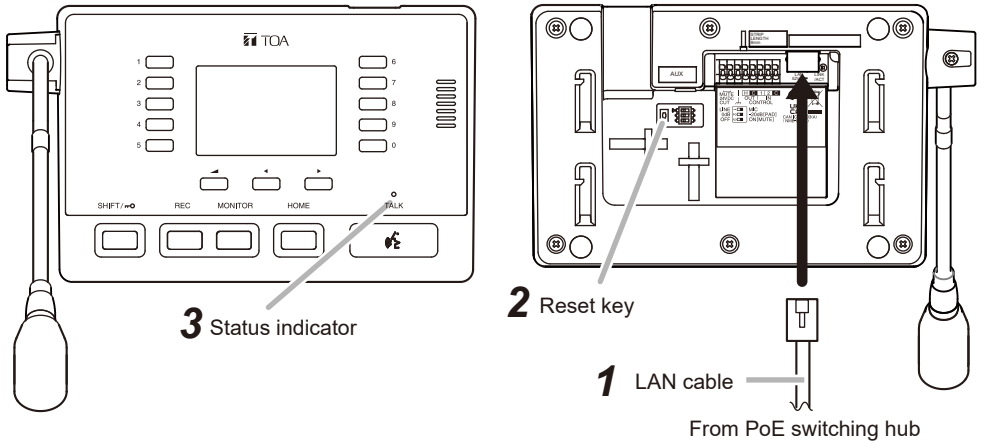

Step 1. Connect the IP Remote Microphone to the PoE switching hub using a LAN cable. The IP Remote Microphone will be started.

Step 2. Hold down the reset key located on the bottom panel using a pointed tool. The IP Remote Microphone automatically restarts and settings initialization begins.

Tip

Clicking on the reset key causes the unit to be restarted.

If pressure on the reset key is released part way through the initialization process, only unit restart will be performed, and the settings will not be initialized.

Step 3. When the status indicator lights yellow, release the reset key. When initialization is complete, the status indicator lights green and all settings will be initialized to their default settings.

[Default Settings]

Username: admin
Password: guest
IP address: 192.168.14.1
Subnet mask: 255.255.255.0
Default gateway: 0.0.0.0

14. CAUTIONS REGARDING THE AVC/H.264 PATENT LICENSE

TOA's IP-A1RM IP Remote Microphone employs MPEG technology (AVC/H.264 Standard) regarding the handling of image information. TOA Corporation has received approval to use this technology from MPEG LA, LLC, the patent management group.

Please note that the use of this product is prohibited except the following cases:

The use of the product is intended for personal use of a user of the MPEG technology and also for non-profit use, which includes (i) video encoding conforming to the AVC/H.264 Standard (hereinafter referred to as "AVC/H.264") and/or (ii) personal use and decoding of AVC/H.264 encoded by an MPEG technology user engaged in non-profit activities and/or AVC/H.264 furnished by a video provider who is granted a license by MPEG LA, LLC.

Regarding use for sales promotion or commercial purposes, or additional licensing information, please contact MPEG LA, LLC (<https://www.mpegla.com>).

15. OPEN SOURCE SOFTWARE

This product uses software based on open source software license(s).

If you need further information about the original open source software including source code, please download it from the TOA DATA Library (<https://www.toa-products.com/international/>).

Please note that we cannot answer any questions about the contents of the original source code.

This product includes software developed by the OpenSSL Project for use in the OpenSSL Toolkit (<http://www.openssl.org>).

This product includes cryptographic software written by Eric Young (eay@cryptsoft.com).

16. SPECIFICATIONS

The specifications of this product are available in TOA DATA Library (<https://www.toa-products.com/international/>).

Scan the QR Code at right with your mobile phone camera to access the WEB site and search for this product number (IP-A1RM).



• Accessories

Cable tie 2

• Optional product

Wall mounting bracket: WB-RM500

Traceability Information for USA

TOA Electronics, Inc.
1 Harmon Plaza, Suite 700 Secaucus, New Jersey 07094,
USA
<https://www.toaelectronics.com/>