



The HydraPanel is a battery-powered LED panel for film, studio and stage lighting. Included with the HydraPanel are six light modifiers consisting of various Diffusors, EggCrates and a GelHolder. The HydraPanel can be mounted with its FlexBase accessory, Babypin and backside magnet. With the ConnectorPlates, up to four panels can be connected to form one bigger panel. For longer installations it can be wired for power and data via an Astera PowerBox.



**Max 20h**



**Wireless DMX**



**IP65**



**App**

## SPECIFICATIONS

	HydraPanel
Order Code	FP6
LED Engine	Titan LED Engine
Colors	RGBMintAmber
Total LED Power	25 W
LED Power Draw	17 W
Luminous Flux 3200K	1102 Lumens
Luminous Flux 4000K	1287 Lumens
Luminous Flux 5500K	1298 Lumens
Light Output 3200 K @ 1m	443 Lux
Light Output 4000 K @ 1m	512 Lux
Light Output 5500 K @ 1m	516 Lux
CRI (Ra)/ TLCI 3200- 6500 K*	≥96
Beam Angle	110° x 100°
Field Angle	150° x 145°
Strobe	0 - 25 Hertz
Pixels	6
Battery Runtime	up to 20 hours
Battery Runtime (max. Brightness)	1 h 45 m
Battery Lifetime	70 % after 300 cycles
Charging Time (nominal)	3 hours
DC Input	24 VDC - 0.85 A
DC Connector	5.5 mm x 2.1 mm
Wired DMX	Yes (via FP1-PWB / FP3-DTL / PWB-2-86)
CRMX Receiver	Built-in
BluetoothBridge BTB	Built-in
Wireless Protocols	CRMX, UHF, Bluetooth, WiFi
Wireless Range	CRMX/UHF up to 300 m / 330 yds Bluetooth up to 3 m / 3.3 yds
Infrared Control	Yes
ControlSync	Yes
TouchSlider	Yes
Housing Material	Polymer & Metal

IP Rating unwired	IP65 (only with PB15-PLG)
IP Rating wired with PWB-CAB-5/-10/-15/-0.2	IP65
Ambient Operating Temperature	0 - 40 °C / 32 - 104 °F
Weight	604 g / 1.3 lb
Dimensions (L x W x D)	166 mm x 85 mm x 43.5 mm / 6.53" x 3.34" x 1.71"
Mounting Options	2 x ColdShoe, 3 x M5 thread, 1 x SafetyWire Eyelet

\*Typical value

## RF CHARACTERISTICS

Wireless Modules	EU: UHF*** (863-870MHz)	USA: UHF (917-922.20MHz)	AUS: UHF (922.30-927.50MHz)	SGP: UHF (920.50-924.50MHz)	KOR: UHF (917.9-921.5MHz)
Modulation	FHSS	FHSS	FHSS	FHSS	FHSS
ERP (Transmitter)	<25mW	<25mW	<25mW	<25mW	<25mW
Channel Count	47	53	53	41	10

Wireless Modules	RUS: UHF (868.75-869.12MHz)	JPN: UHF (922.80-926.40MHz)	CRMX (2402-2480MHz)	Bluetooth 5.0 LE (2402-2480MHz)	WiFi (2412-2472MHz)
Modulation	FHSS	FHSS	FHSS	FHSS	DSSS, OFDM
ERP (Transmitter)	<25mW	<25mW	-	10mW (BLE)	<100mW
Channel Count	6	19	79	40	13

\*\*\*General allocation of frequencies for use by short-range radio applications

## HYDRAPANEL AS BLUETOOTH BRIDGE

Connect the App directly to a HydraPanel via Bluetooth. This light will then transmit commands from the AsteraApp to all other HydraPanels and other Astera lights via the UHF band.

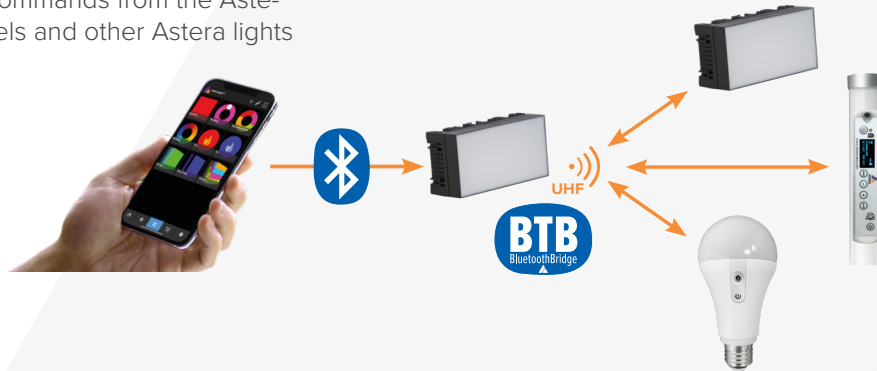

## DRAWINGS

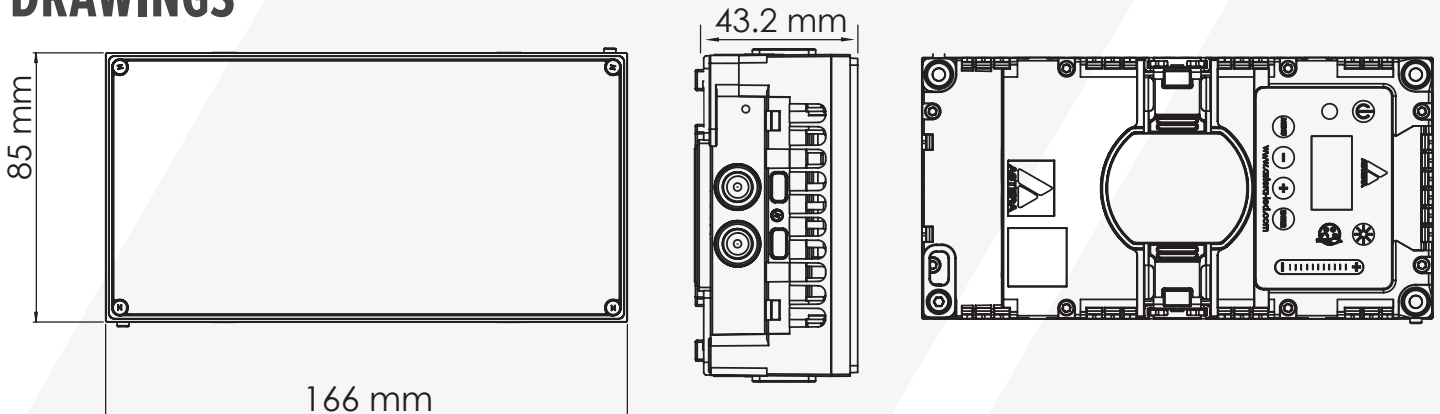

# BUILT-IN FEATURES

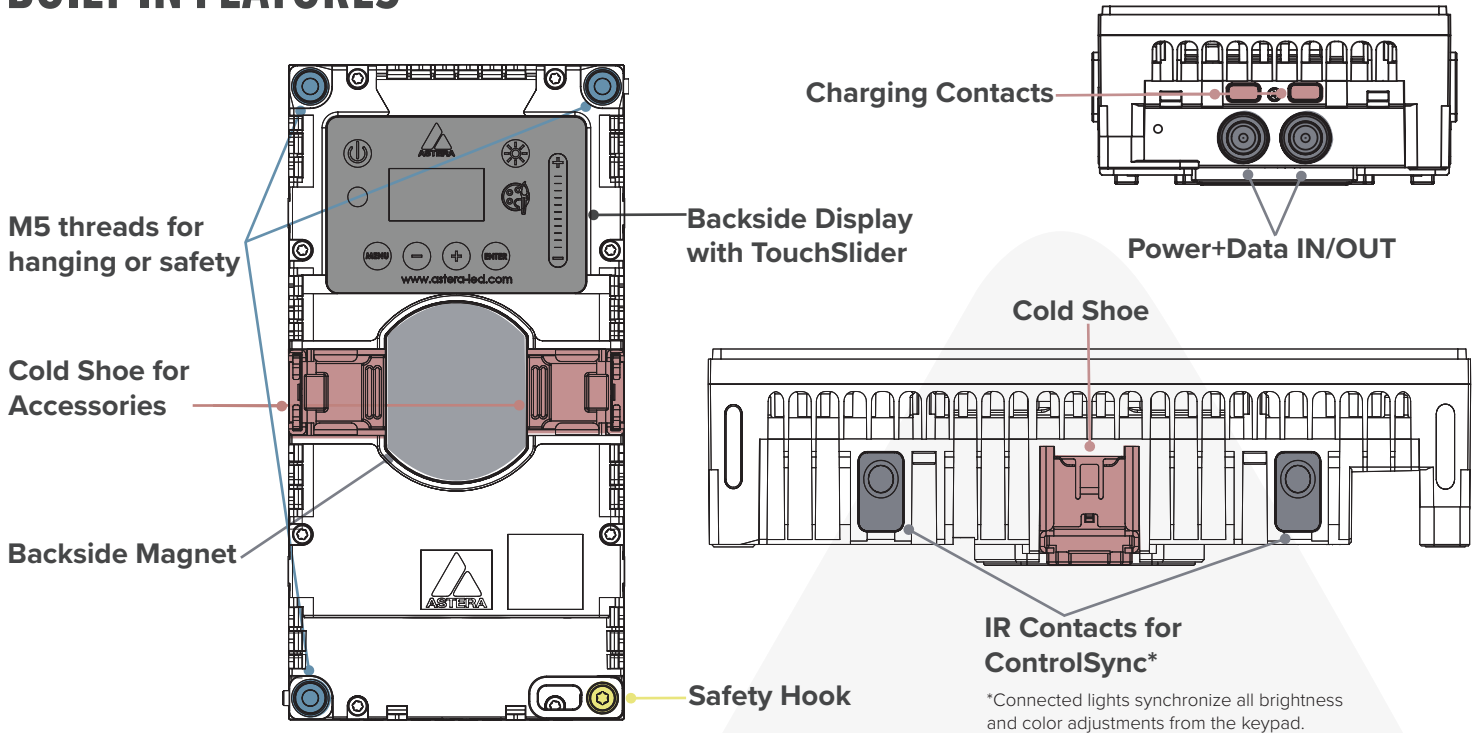

# ACCESSORIES

**FlexBase**  
FP6-FB

included



**Mounting points**

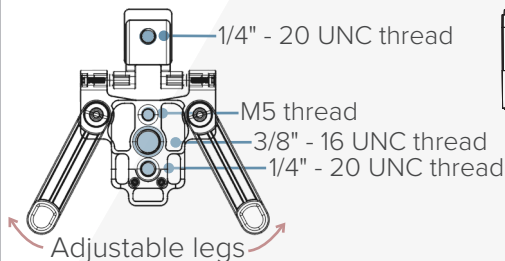

**Slide into Cold Shoe**

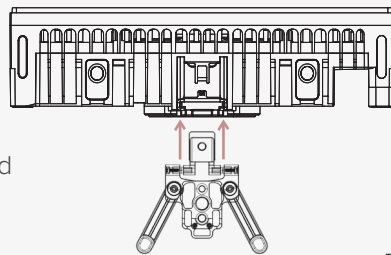

**Tiltable**

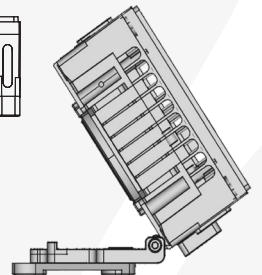

**ConnectorPlate**  
FP6-CP

included

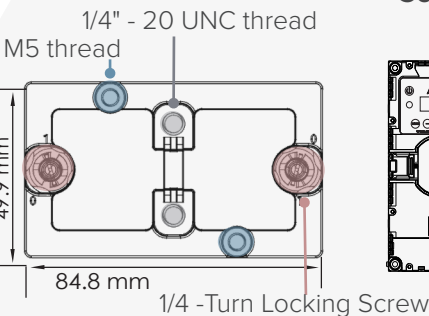

**Connect up to 4 HydraPanels**

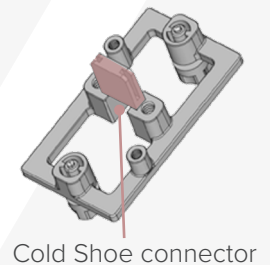
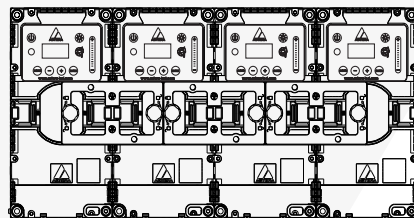

**BabyPin 1/4"**  
AX-BBP-1/4

included



**200 mm Power / DataCombination Cable**  
PWB-CAB-0.2



**Power Supply for Helios/ Titan Tube**  
FP1-CHR



**Power Supply for Hyperion Tube**  
FP3-CHR



**EyeBolt**  
FP1-EBLT



**SNAPBAG by DoPchoice**  
SBATHY11



**LIGHT MODIFIERS** all included

**SoftFrame 100**  
FP6-SF-100



**Intensifier 80**  
FP6-INT-80



**CASES EMPTY**  
**Single Unit Case**  
FP6-CSE-1



**KITS FULL**  
**Single Unit Kit**  
FP6-SET-1



**EggCrate 40**  
FP6-EGC-40



**EggCrate 60**  
FP6-EGC-60



**Charging Case for 4**  
FP6-CHRCSE-4



**Kit for 4**  
FP6-SET-4



**DiffusorSheet 100**  
FP6-DS-100

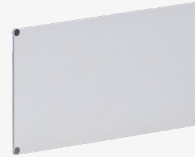

**GelHolder**  
FP6-GH



# CHARGING & CONNECTING

With PowerBox 2x86 (PWB-2-86) up to four HydraPanels can be connected per output

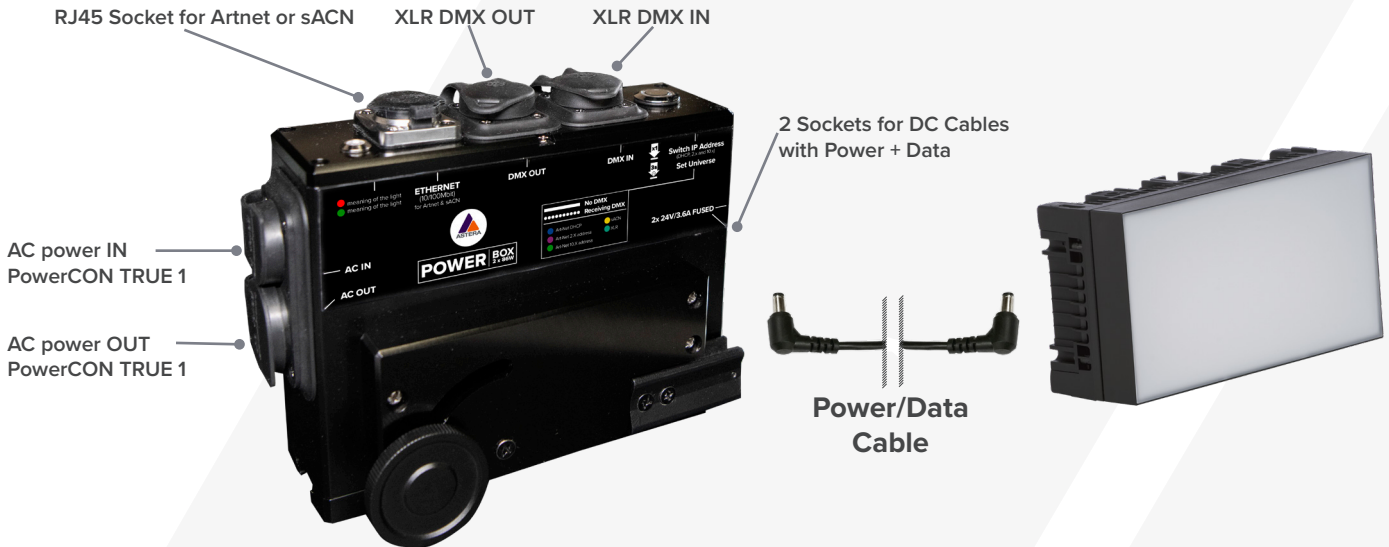

With Titan PowerBox (FP1-PWB) up to two HydraPanels can be connected per output

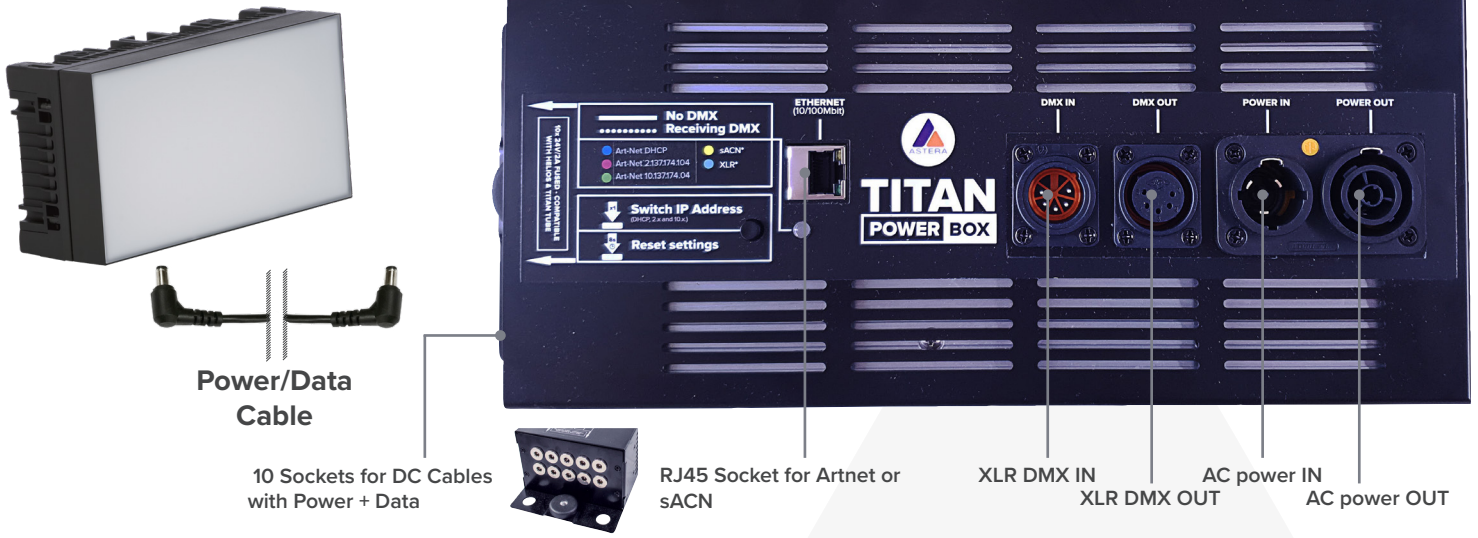

## TYPICAL SPECTRAS

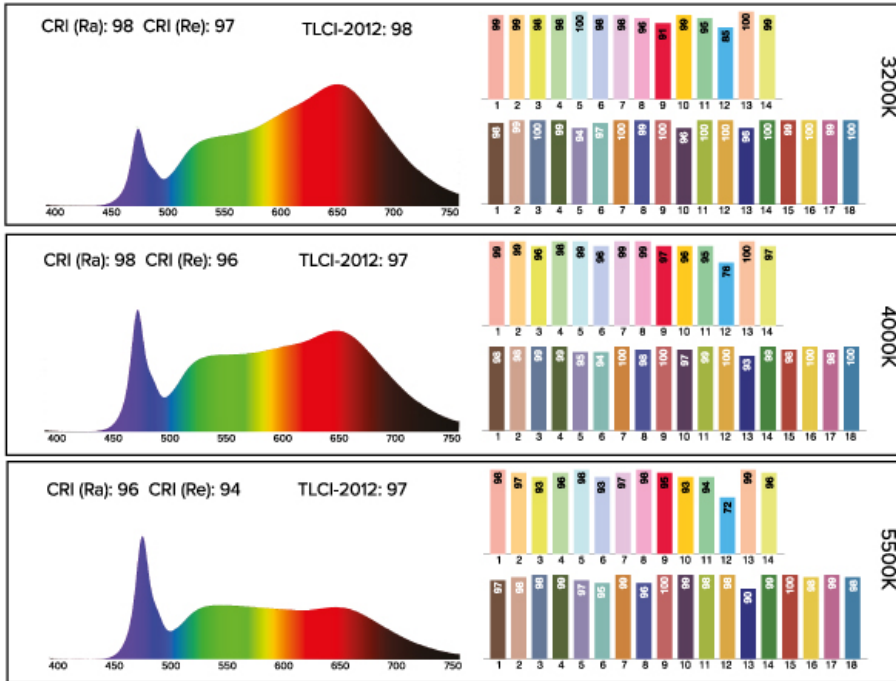

\*Typical values