

# EVU-2062/95

## Dual 6.5" Two-Way 90° x 50° Full-Range Loudspeaker System



### Key Features:

- 1.3" (33 mm) diaphragm, 1.4" (36 mm) exit pure titanium compression driver
- Dual 6.5" (165 mm) LF transducers
- Advanced third-order crossover network with HF protection
- Coverage pattern: 90° x 50° Constant Directivity™ rotatable waveguide
- 94 dB sensitivity, 125 dB maximum SPL
- System rating: 300 W continuous, 1200 W peak
- Universal U-bracket included
- 70.7/100-V transformer accessory optional
- NL4 cover plate accessory optional
- (6) M8 threaded suspension points

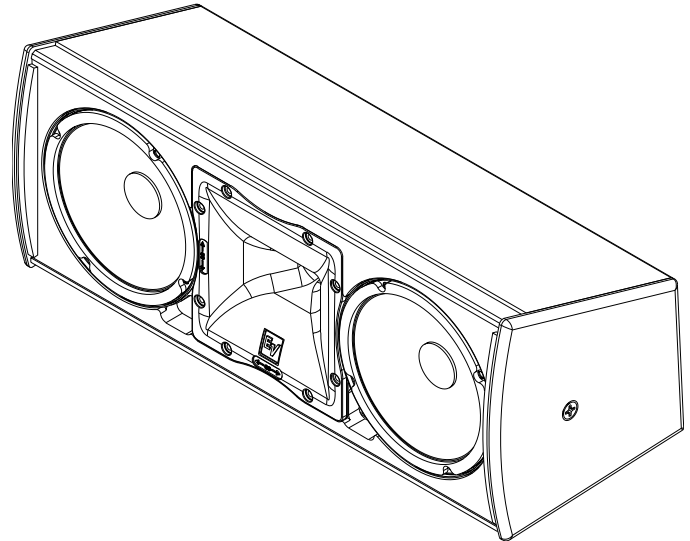

### General Description:

The Electro-Voice EVU-2062/95 is a compact two-way loudspeaker system that can be used in a variety of applications where high quality sound reinforcement is required in an ultra-compact lightweight enclosure. The enclosure design utilizes asymmetric angles to maintain tight clearances to wall and ceilings while providing optimal coverage patterns making it ideal to blend into surroundings. This design was optimized for wall, stage lip and under balcony applications.

The EVU-2062/95 incorporates the ICT-1-8, a high-output 1.3" diaphragm titanium compression driver coupled to a Constant Directivity™ 90° x 50° rotatable waveguide. The ICT-6.5-16 woofer was developed using FEA optimization to provide the highest sensitivity while achieving the highest level of speech intelligibility. The crossover design uses 18-dB-per-octave slopes with equalization for very smooth response in the vocal range, linear off-axis response and a protection circuit for long term reliability.

The EVU series is constructed of 9-ply hardwood plywood enclosures with six integral M8 suspension points to support a wide variety of mounting positions. The EVU system is finished in textured paint, available in either white or black. Each EVU system includes a universal U-bracket to facilitate mounting. The U-bracket provides full unobstructed rotation of the loudspeaker (330° unobstructed rotation if the transformer kit is installed). Additional mounting points are located on the rear of the enclosure for use with an Omnimount™ type bracket. An available 70.7/100-V transformer kit may be easily mounted over the input panel for use in distributed systems. All of these features give you the flexibility to address a large range of venues, while quickly and precisely supporting customer requirements.

### Technical Specifications:

Freq. Response <sup>1</sup> (-3 dB):	100 Hz - 16 kHz
Freq. Range <sup>1</sup> (-10 dB):	70 Hz - 20 kHz
Rotatable Coverage:	90° x 50°
Rec. High-Pass Frequency:	90 Hz
Passive Crossover Freq.:	2400 Hz
Axial Sensitivity <sup>1</sup> :	94 dB (1 W/1 m)
Max. Calculated SPL <sup>1</sup> :	125 dB
Passive Power Handling <sup>2</sup> :	300 W continuous, 1200 W peak
Impedance:	8 ohms (nominal), 6.0 ohms (min.)
LF Transducers:	Dual ICT-6.5-16, 6.5" (165mm) drivers
HF Transducer:	ICT-1-8, 1.3" (33mm) diaphragm compression driver
Connectors:	Single four-pin 12 AWG Phoenix/Euro Block screw-terminals
Enclosure:	9-ply hardwood plywood with textured paint
Grille:	18 GA steel with cloth
Environmental:	IEC 60529
Suspension:	(6) M8 threaded suspension points
Dimensions (H x W x D):	8.21" x 20.98" x 8.14" (208.4 mm x 532.9 mm x 206.7 mm)
Net Weight:	25.0 lb (11.3 kg)
Shipping Weight:	31.2 lb (14.2 kg)

<sup>1</sup> Half-space measurement.

<sup>2</sup> EIA RS-426A, tested for eight hours.



# EVU-2062/95 Loudspeaker System

## Frequency Response & Impedance:

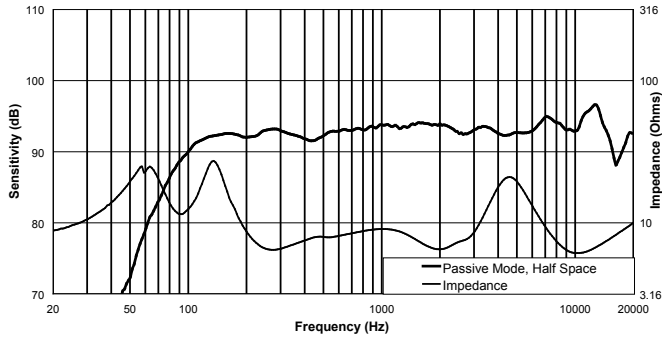

## Horizontal Off-Axis Frequency Response:

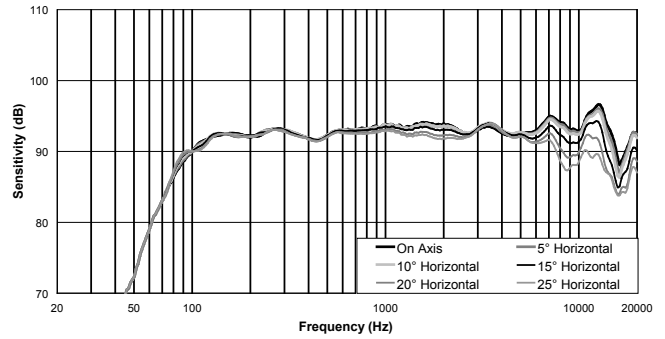

## Vertical Off-Axis Frequency Response (Up):

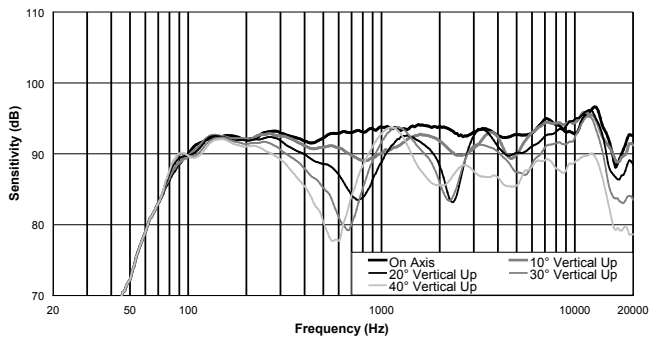

## Vertical Off-Axis Frequency Response (Down):

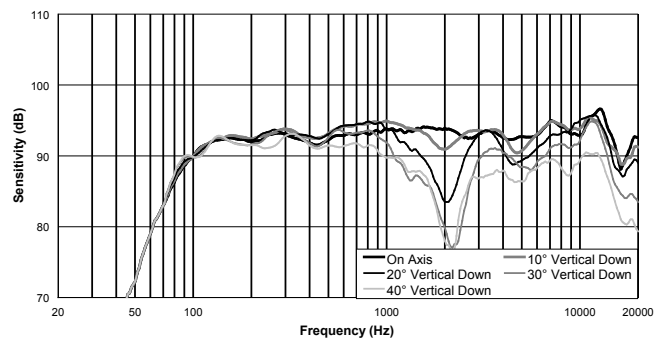

## Beamwidth:

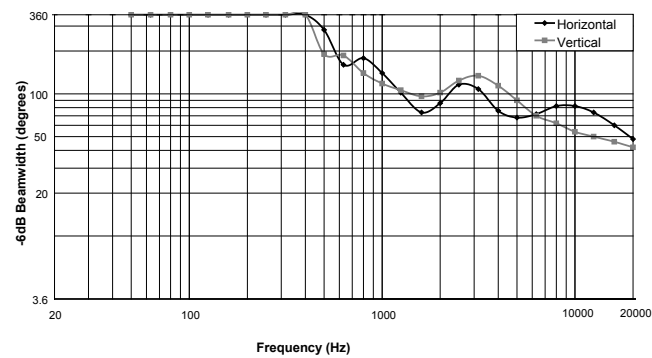

## Directivity:

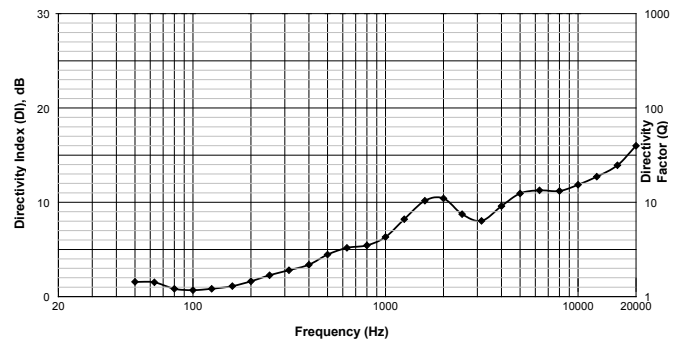

## Block Diagram:

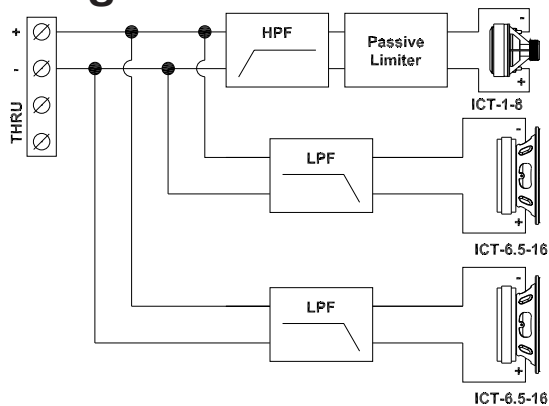

## Polar Plots (1/3 Octave):

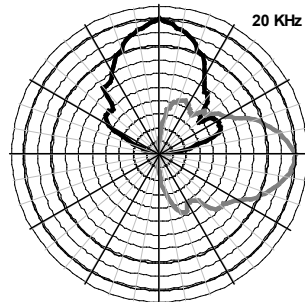
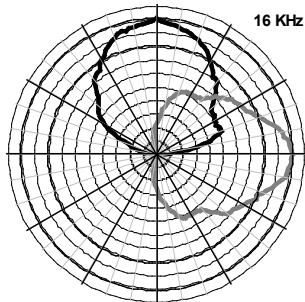
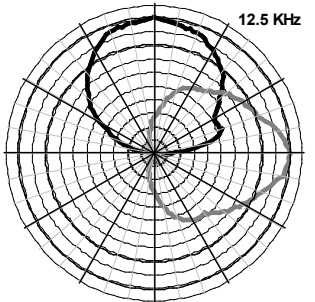
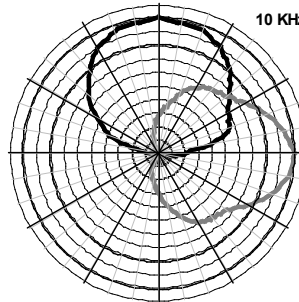
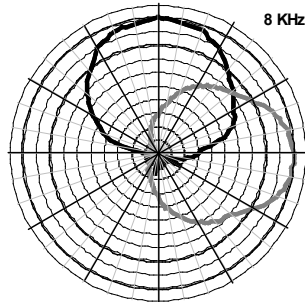
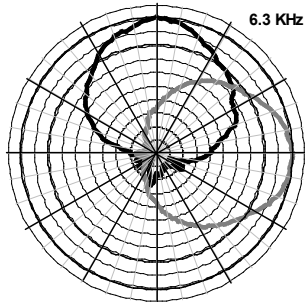
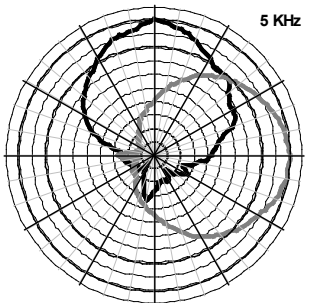
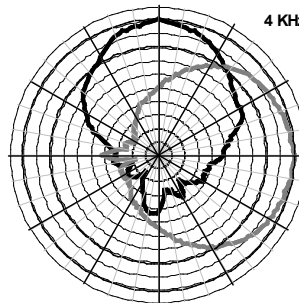
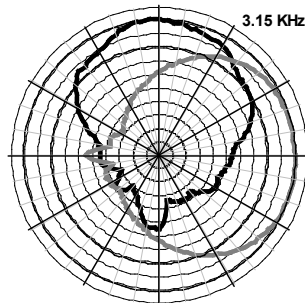
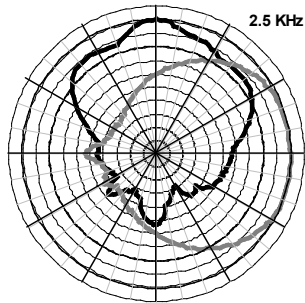
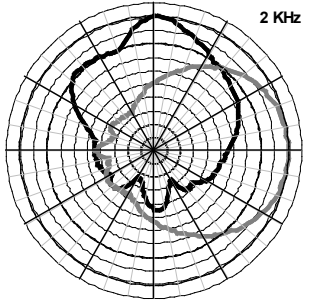
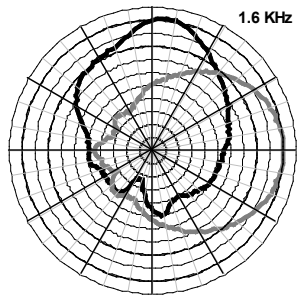
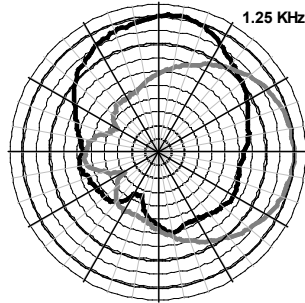
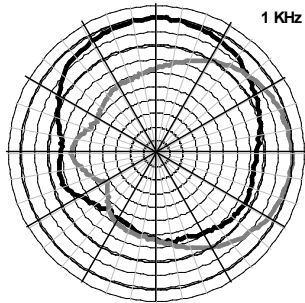
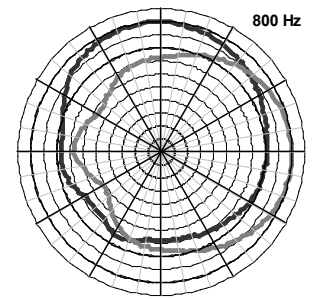
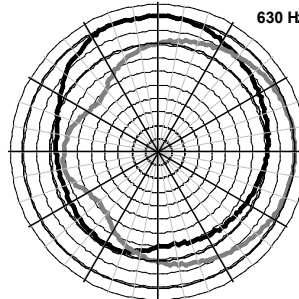
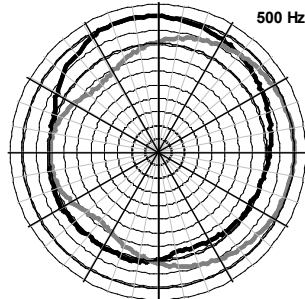
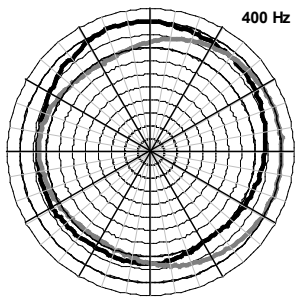

**Horizontal = Black**  
**Vertical = Grey**

## Dimension Drawings:

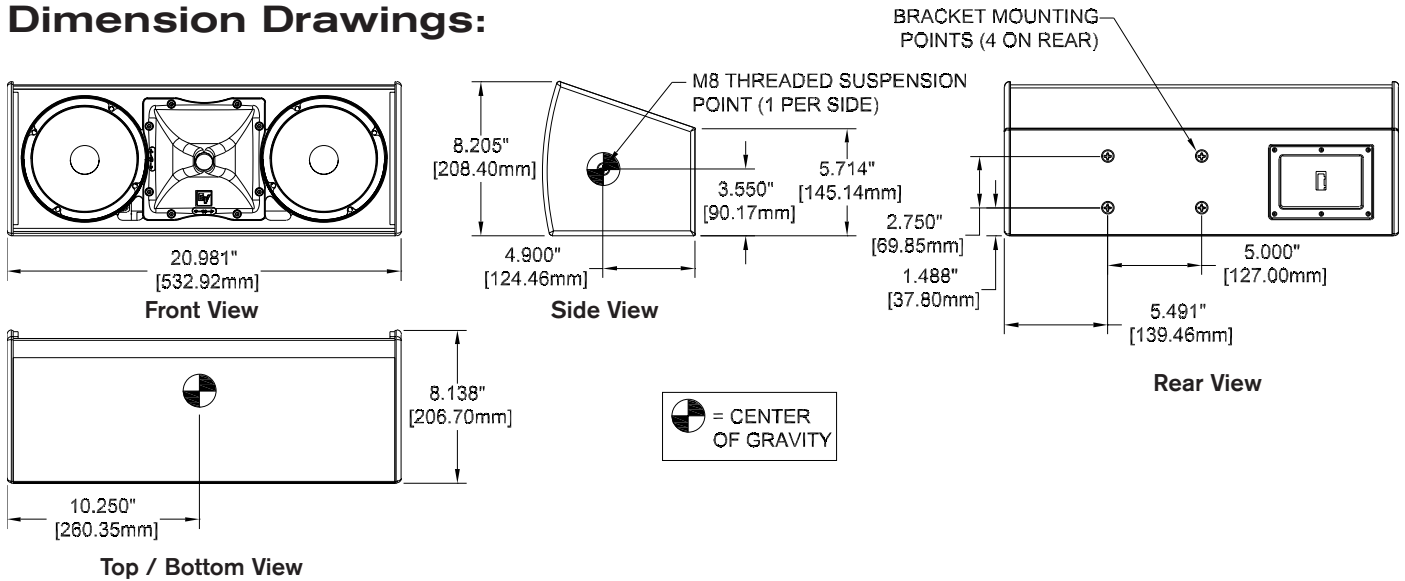

### EVU Series Part Numbers

- EVU-1062/95-BLK, 90° x 50°, black finish
- EVU-1062/95-WHT, 90° x 50°, white finish
- EVU-2062/95-BLK, 90° x 50°, black finish
- EVU-2062/95-WHT, 90° x 50°, white finish
- EVU-1082/95-BLK, 90° x 50°, black finish
- EVU-1082/95-WHT, 90° x 50°, white finish
- EVU-2082/95-BLK, 90° x 50°, black finish
- EVU-2082/95-WHT, 90° x 50°, white finish

### Accessories

- EVU-TK60, 70V transformer, 60W
- EVU-CDNL4, cover plate, NL4

### Performance Match

- EVA "S" Series, Full-Range Line-Array Modules
- EVA "D" Series, Subwoofer Line-Array Modules
- EVF "S" Series, Full-Range Loudspeakers and Subwoofers
- EVF "D" Series, Full-Range Loudspeakers and Subwoofers
- EVH "S" Series, Full-Range Coaxial Loudspeakers
- EVH "D" Series, Full-Range Coaxial Loudspeakers
- CPS2.4 MKII, power amplifier, 2 x 200W
- CPS2.6 MKII, power amplifier, 2 x 250W
- CPS4.5, power amplifier, 4 x 450W
- CPS8.5, power amplifier, 8 x 450W



This EVU loudspeaker should be suspended overhead only in accordance with the procedures and limitations specified in the *EVU User Manual* and possible manual update notices. This system should be suspended with certified rigging hardware by an authorized rigging professional and in compliance with local, state, and federal overhead suspension ordinances.

## Electro-Voice

12000 Portland Avenue South, Burnsville, MN 55337  
 Phone: 952/884-4051, Fax: 952/884-0043

www.electrovoice.com

© Bosch Communications Systems 05/2011  
 Part Number F01U216886 Rev 3

U.S.A. and Canada only. For customer orders, contact Customer Service at:  
**800/392-3497 Fax: 800/955-6831**

Europe, Africa, and Middle East only. For customer orders, contact Customer Service at:  
**+ 49 9421-706 0 Fax: + 49 9421-706 265**

Other International locations. For customer orders, Contact Customer Service at:  
**+ 1 952 884-4051 Fax: + 1 952 887-9212**

For warranty repair or service information, contact the Service Repair department at:  
**800/685-2606**

For technical assistance, contact Technical Support at: **866/78AUDIO**

Specifications subject to change without notice.