

Alice - 1469TC

COMPACT - LED 600 W



- **Type:** Followspot
- **Source:** LED 600 W
- **Optics:** 13° to 24° zoom
- **Colour temperature:** Cool White
- **Version:** Top control - PTO

Followspot

Too bright to ignore !

Alice is proof that Robert Juliat continues to lead the way in followspot design ! The new dynamic short-throw model features an exclusive 600W cool white LED source and is the first professional LED followspot able to deliver a high output comparable with that of 1200W discharge followspots. With its compact dimension, silent operation, smooth electronic dimming, top controls (iris/dimming) and the benefits of no lamp change and powerful output, Alice is the ideal truss spot for larger venues and full size theaters.

Features

- **Fully closing iris:** control from the top of the unit; protective backplates for extended lifespan
- **Universal adjustable gobo holder:** "A" size glass and metal gobos
- **Local control:** light intensity adjustment through built-in potentiometer
- **Dimmer control lever on top:** one-handed dim and iris - PTO (Push To Open) model
- **Horizontal chopper (optional):** for masking control in TV studios and wide stages
- **Internal glass filter holder:** long term use of durable coloured, dichroic or textured glass
- **Individually removable colour frame:** gels replaced easily while colour cassette remains in place
- **Colour changer:** 6-way, 'push/pull' colour changer system for simultaneous use of multiple filters
- **USB connector:** for connection of additional accessories
- **Adjustable response time:** choice of fast or slow dimming for tungsten-like simulation - adjustment by DMX protocol
- **Universal data control:** compatible with DMX, RDM, Art-Net, sACN protocols
- **Remote setup:** all parameters can be adjusted by RDM protocol
- **DMX:** 8 or 16 bit dimming and strobe function
- **Local setup:** dMX address and mode, dimming curve and response time through 4-button display with automatic light switch-off
- **Control:** local and DMX
- **Dimming parameters:** choice of square or linear dimming curves
- **Easy focus reference:** graduated scale on side of the unit; fast and easy refocusing
- **Adjustable yoke (optional):** for optimum overhead positioning
- **Fine balance:** precision positioning and smooth operation even with the smallest movements
- **Stand:** perfectly weighted for maximum stability with smooth rotation for optimum performance. Easy set up; triple safety system for extra security

Optical

- **Long life:** outstanding operational lifetime expectation, no need to replace lamps, low maintenance
- **High output:** comparable to 1200W discharge followspots
- **Gobo :** excellent gobo projection
- **Optical quality:** smooth flat beam, no hot spot
- **Variable zoom optics:** sharp focus at every beam angle. Independent control of image size and focus.
- **Electronic dimmer:** dimming without clipping or cut-out at low intensity levels; high quality smoothing
- **No colour shift:** colour temperature remains the same when dimming

Construction

- **Made in France :** fully manufactured in Robert Juliat premises retaining complete control over all aspects of quality
- **PSU:** built-in electronic flicker-free power supply for easy, plug-and-play installation
- **Power connectors:** neutriK® powerCON TRUE1 TOP IN and OUT connectors for daisy chaining
- **Silent-running cooling fans:** ideal for TV studios and opera houses
- **Electronic thermal management system:** ensures maximum performance of the system without any risk of overheating
- **Bodywork:** strong sheet metal construction for durability
- **Ergonomic wrap-around handle:** comfort, safety and practicality from all operating positions
- **Moving parts:** smooth at all times, even when hot
- **Captive knobs and handles:** additional security when working at height or in transit
- **Easy access to all parts:** easy cleaning and maintenance

Picture:1469TC

DSEN360_1469TC - 02/10/2023

Robert Juliat reserves the right to change or alter any of the items detailed on this page, to increase or improve manufacturing techniques without prior notice.

Robert Juliat S.A.S., 32 rue de Beaumont, 60530 Fresnoy-en-Thelle - France
Telephone : +33 (0)3 44 26 51 89 - info@robertjuliat.fr - www.robertjuliat.com



ROBERT JULIAT

- Lamp type: LED
- Power: 600 W

LED specifications	Power *	Lumen output*	Colour temperature*	Life*	CRI* (min)
LED 600W	600 W	32 500 lm	6000K	20 000 h	91

(*) manufacturer's data

Optics

Characteristics

- Type: Zoom
- Range: 13° to 24° (Field angle)
- Focal length: 169 - 316 mm

Gel filter

- Shape: Circle
- Standard size: 210 mm (8.3 in)

Gobo

- Size: A
- Material: Metal
Glass

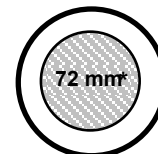

100 mm
*Maximum image size

Photometrics

optics: 13°-24° / Standard

• Optics @ 13°

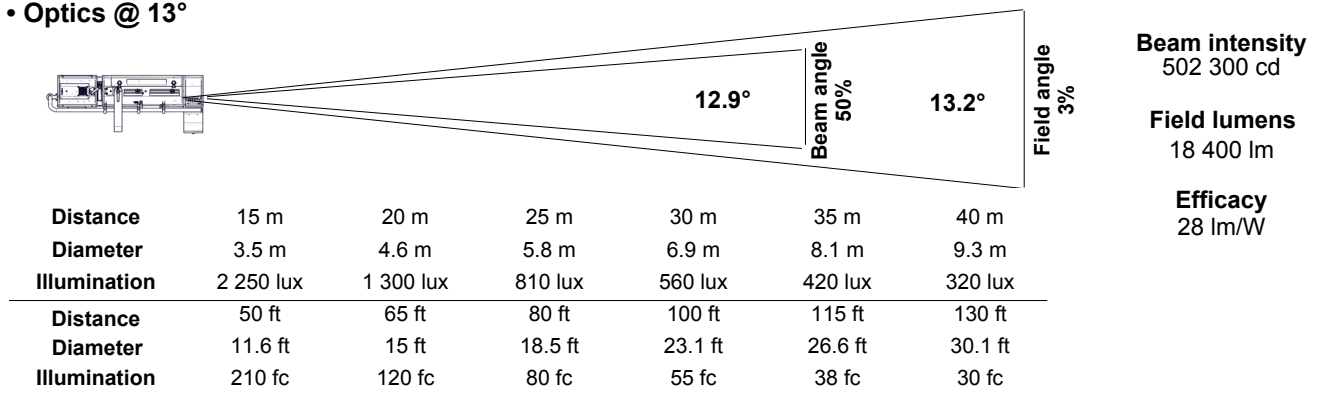

• Optics @ 24°

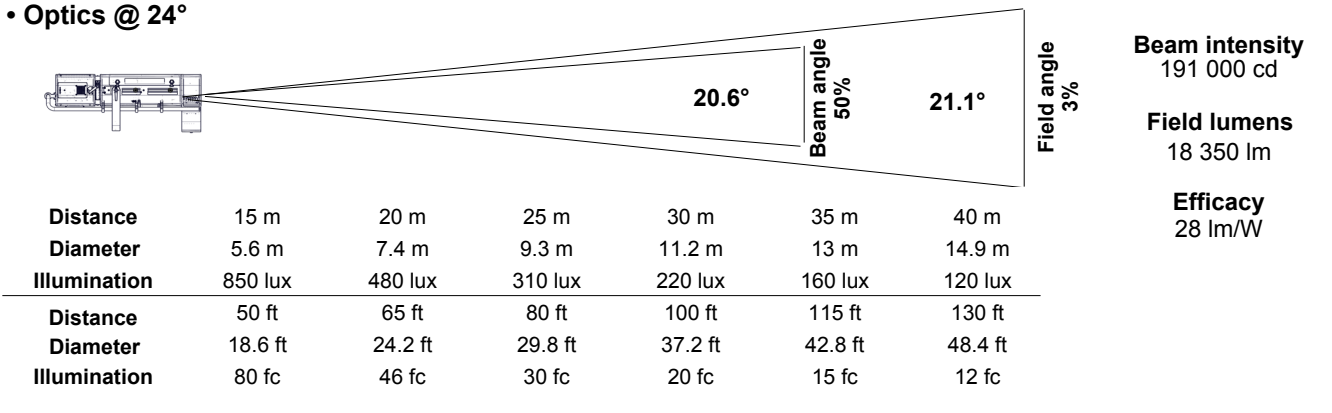

Remote control

- Data protocol: USITT DMX512-A
RDM / Art-Net / sACN

- Data IN connector: 5 pins XLR mâle + etherCON RJ45
- Data OUT connector: 5 pins XLR femelle



• DMX chart:

Mode 1 (1 channels)	Mode 2 (2 channels)	Mode 3 (5 channels)	Mode 4 (6 channels)	Mode 5 (6 channels)	Mode 6 (8 channels)
Dimmer	Dimmer Dimmer fine	Dimmer Strobe duration Strobe speed Response time Control mode	Dimmer Dimmer fine Strobe duration Strobe speed Response time Control mode	Dimmer Master dimmer Strobe duration Strobe speed Response time Control mode	Dimmer Dimmer fine Master dimmer Master dimmer fine Strobe duration Strobe speed Response time Control mode

Dimensions and weight

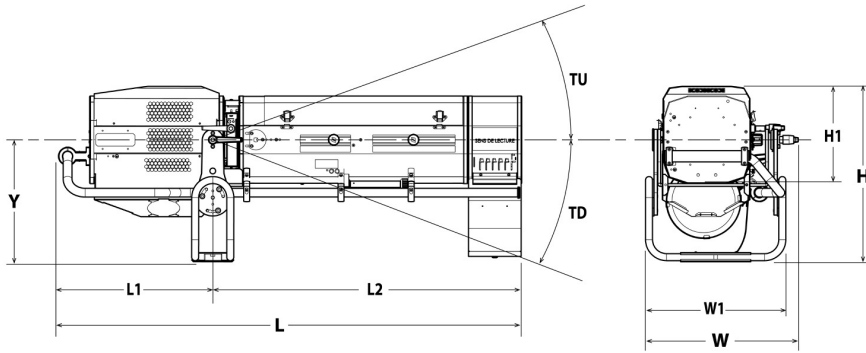

Weight: 40 kg (88 lbs)

Height	Length	Width	Yoke	Tilt	Option
H= 480 mm (18.9 in)	L= 1033 mm (40.7 in)	W= 418 mm (16.5 in)	Y= 325 mm (12.8 in)	TU= 35°	TO= 65°
H1= 375 mm (14.8 in)	L1= 441 mm (17.4 in)	W1= 350 mm (13.8 in)		TD= 45°	
	L2= 592 mm (23.3 in)				

Shipping

- **Weight :** 54 kg (118.8 lbs)
- **Volume :** .39 m³ (13.62 ft³)

Installation

- **Minimum distance to illuminated surface:** 1.0 m (3.3 ft)
- **Operating position:**



Construction

- **Housing:** Steel sheet - Aluminium
- **Colour:** Black
- **Cooling:** Variable fans
- **Maximum ambient temperature (Ta):** 40°C (104°F)
- **Maximum case temperature (Tc):** 65°C (149°F)
- **Total heat dissipation:** 2 184 BTU/h
- **Ingress Protection (IP) rating:** IP20

Electrical compatibility

- 220/230 V - 50 Hz
- 245 V - 50 Hz
- 110/120 V - 60 Hz
- 208 V - 60 Hz
- 220/230 V - 60 Hz
- 100 V - 50 Hz
- 100 V - 60 Hz
- Selector: automatic detection

Power input



- **Type:** removable power cord with Neutrik powerCON TRUE1 TOP connector (included)
- **Cable:** H07RNF 3G1.5
- **Length:** 3 m (9.8 ft)
- **Power connector:** CEE 7/7 (2P+E NF/Schuko)

Power consumption

Voltage	Frequency	Current	Power	Power factor
230 V	50 Hz	2.8 A	640 W	0.99
120 V	60 Hz	5.5 A	649 W	0.99
100 V	60 Hz	6.7 A	655 W	0.99

Power Supply Unit

- **PSU:** Internal - Electronic PSU - Flicker free with PFC
- **Control:** Local / DMX
- **Protection:** -
- **Power thru:** Neutrik powerCON TRUE1 TOP - Maximum of 5 units (230 V) / 2 units (120 V)

Warranty

- **Fixture: 3 years**
See General Sales Condition on website

Approvals







Acoustics

- **Noise level:** < 39,9 dB(A)









Model



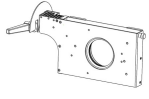











1469TC	LED 600 W Followspot - 1469TC Alice - Cool White - 13/24° - Top Control PTO
---------------	---

Options

PCP1716A	16A blue 2P+E 6h IEC60309 power connector	
FRO/1117PV	Heavy duty adjustable yoke	
FRO/SMEPV	Heavy duty adjustable yoke equipped with TILT SpotMe sensor (E type)	
CAV700P2	Double slot front cassette for 215x215mm accessories (instead of "push/pull" colour hanger)	
CAG/CL	Left side controls option for LED Compact range (Iris/Dimmer/Frost/Colour changer/Display)	
FC1169	Flight-case for Compact range (LED version) / GT stand / accessories - Dim: 1340x710x700mm - Weight: 55 Kg	

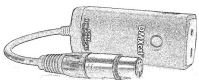
Accessories

PF1011	Ø210 mm metal filter holder 6 included	
SGUP2	Universal "A" size gobo-holder (metal, glass, frosted glass) 1 included	
VDM100	Ø97mm frosted glass with holder 1 included	
CCU1SM	Full closing iris cassette with position sensor for SpotMe system - Ø72mm	
GT4000	Tripod stand with safety chain - SWL: 130 Kg - max. height: 1030 mm - Poids: 7.91 Kg	
GT4000RSM	Tripod stand with ball head rotation with security chain and SpotMe PAN sensor - SWL: 130 Kg - max. height: 1030 mm	
GT4000S	Tripod stand without safety chain - SWL: 130 Kg - max. height: 1030 mm - Poids: 8.65 Kg	
JPP	Monopod stand for overhead followspot - Poids: 3.6 Kg	
T1000	TV spigot with followspots swivel head - Poids: 1.82 Kg	
T4000	Followspot mount for Ø50mm pipe (suspension or overhead) - SWL= 100 Kg - Poids: 4.88 Kg	

T4000RSM	Followspot mount with ball head rotation and SpotMe PAN sensor - SWL = 100 Kg - Poids: 8.53 Kg	
CAV700A	Double slot front cassette for 215x215mm accessories - Poids: 0.52 Kg	
FCM100R	Ø97mm 1/2 CTO correction filter (Rosco #3408) with holder	
VD120	120x120mm frosted glass	
FRO/1017PD	Heavy duty adjustable yoke - Poids: 4.33 Kg	
FRO/SMEPD	Heavy duty adjustable yoke equipped with TILT SpotMe sensor (E type)	
BK1	Followspot balancing kit (including 1 Kg counterweights)	
Kit TELRAD	Telrad followspot sight with raiser and universal mounting kit - Poids: 1.23 Kg	
SDUP	Followspot cue sheet holder with universal mounting kit	
TCSM	SpotMe calibration tool kit	
DMXcat	Bluetooth DMX/RDM Multifunction test tool - City Theatrical DMXcat®	
Maestro	Maestro server for SpotMe - rackable unit: 1U - half 19" - Poids: 1.2 Kg	
P2FU	Dual-function programmable remote controller - USB connector	
SMS	SpotMe server + 2 sensor cables + flight case	
FC1169/S	Flight-case for Compact range (LED version) / GT stand / accessories - Poids: 55 Kg	

Light quality report

CCT	DeltaUV	CRI Ra	CRI R9	CQS Qa	TM30-18 Rf	TM30-18 Rg	TLCI
5 660K	0.0028	91	57	88	88	95	90

CRI - CIE Colour Rendering Index

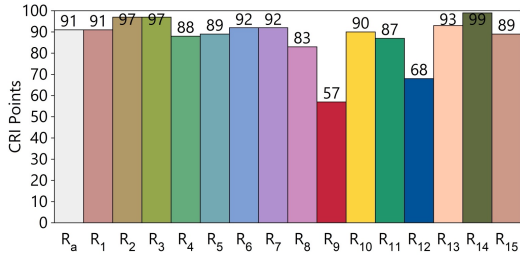

TLCI - Television Lighting Consistency Index

Test : CCT = D5662 (-0.1)
 TLCI-2012 : 90 (D5662)

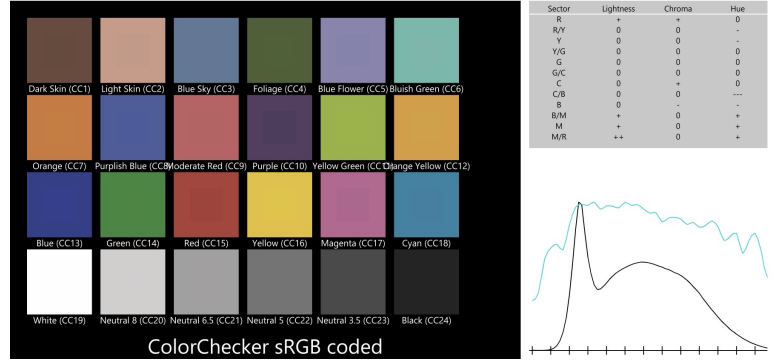

CQS - NIST Colour Quality Scale

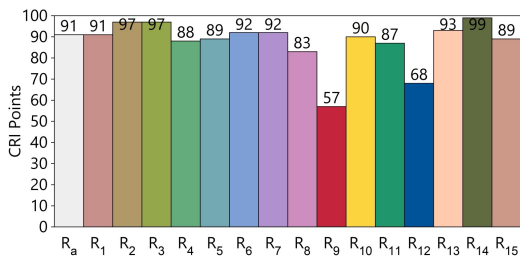

ANSI/IES TM-30-18 Colour Rendition Report

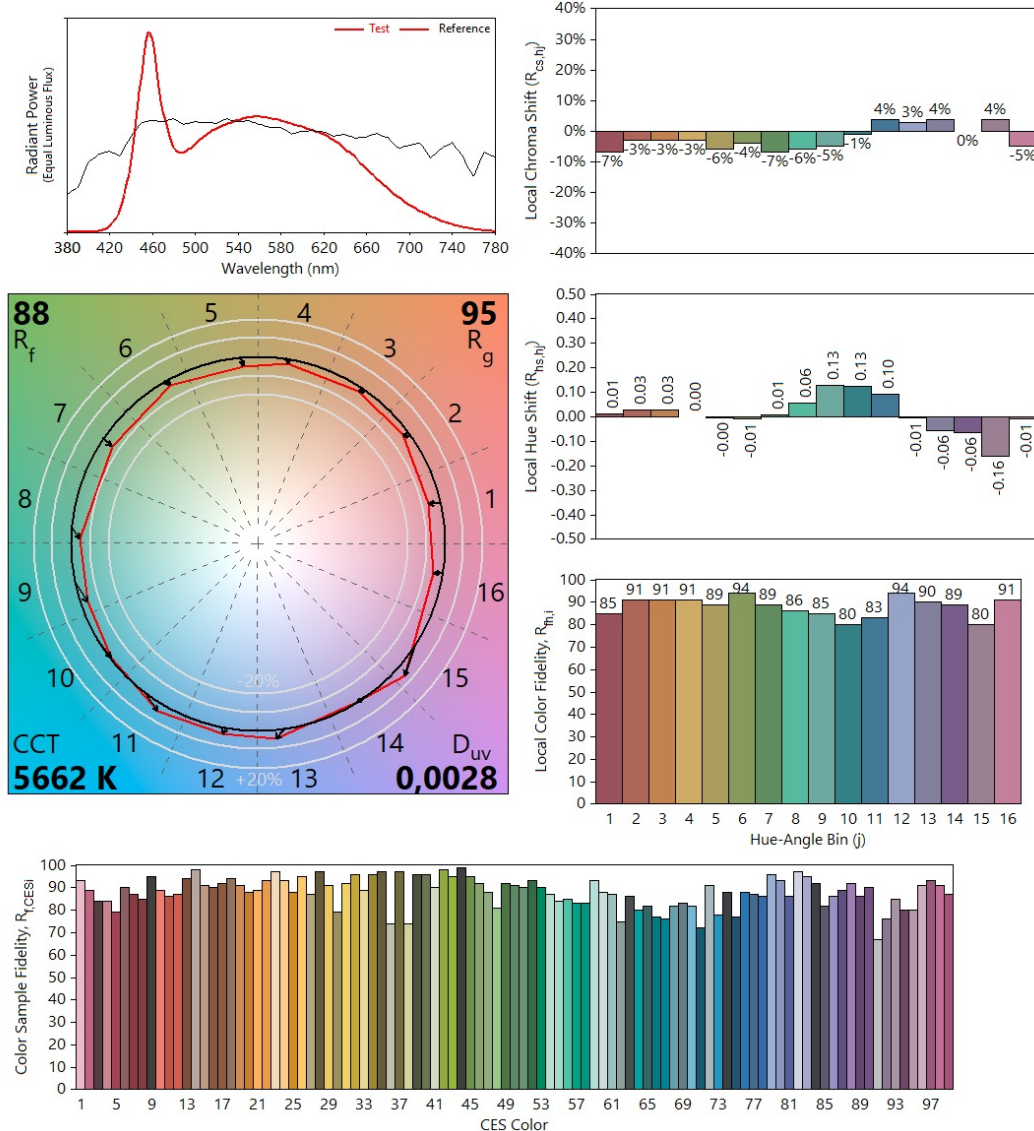

Colours are for visual orientation purposes only. Created with the IES TM-30-18 Calculator Version 2.00