

DALIS ACCESS 863

CYCLIODE
CYCLIGHT

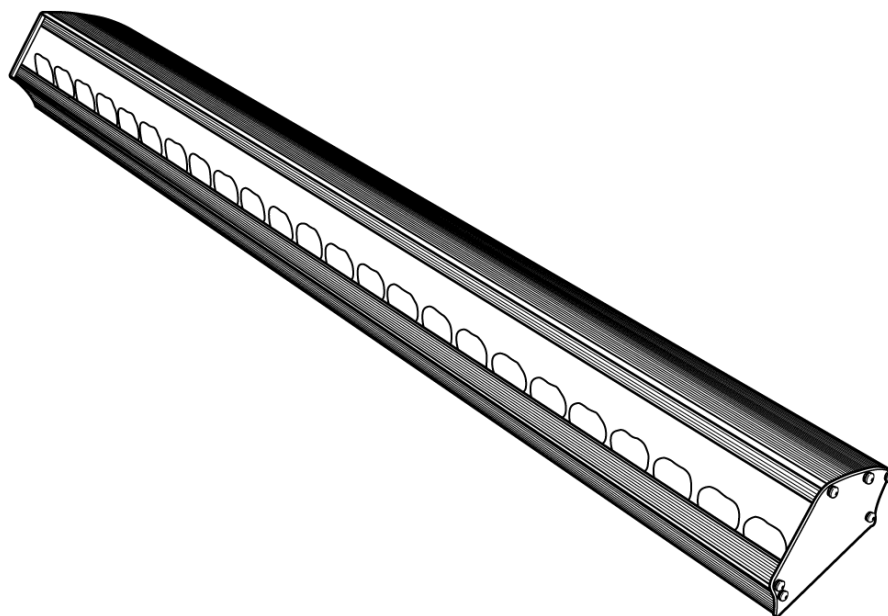

*CYCLIODE 150W LED 4 COULEURS
4 COLOURS LED 150W CYCLIGHT*

<i>MODEL</i>	<i>LENGTH</i>	<i>POWER</i>
<i>863</i>	<i>100 CM</i>	<i>150 W</i>

DALIS 863
Firmware V1.XX

Validation : 02/08/19

DN41149300



ROBERT JULIAT

Table of contents

1	User's instructions	1
2	Presentation	2
2.1	Functions	2
2.2	Identification plate	2
2.3	Accessories included	3
2.4	Optional accessories	3
3	Set-up.....	4
3.1	Mechanics	4
3.2	Electrical	7
3.3	DATA	8
4	Operation.....	10
4.1	Light intensity	10
4.2	Colours	11
4.3	Strobe	12
4.4	Group.....	13
4.5	Response time	13
5	Control and parameters	14
5.1	Local display and Controls.....	14
5.2	DMX512-A remote control	16
5.3	RDM remote control	19
5.4	Art-Net remote control	20
5.5	sACN remote control	21
6	Service	22
6.1	Preventive maintenance	22
6.2	Analysis.....	22
6.3	Electronic thermal management system	22
6.4	Firmware update	22
6.5	Factory defaults.....	22

1 User's instructions

GENERAL INSTRUCTIONS

1. Not for residential use.
2. **These fixtures must only be serviced by a qualified technician.**
3. In addition to the instructions indicated on this page, relevant health and safety requirements of the appropriate EU Directives must be adhered to at all times.
4. This fixture is in compliance with section 17 - Lighting appliance for theatre stages, television, cinema and photograph studios. Standards NF EN 60598-1 and NF EN 60598-2-17.
5. This fixture is rated as IP20, and is for indoor use only.

FIXTURE

6. Ensure fixture is correctly mounted on an appropriate support.
7. Protection screens must be replaced in the event of any damage, such as cracks or deep scratches, since these might reduce performance.
8. When hung or flown the fixture must be secured by an additional hanging accessory (such as a safety cable or bond) of suitable length
9. Safety bonds or cables must be securely attached to the fixture and be as short as possible, or rolled up as necessary, to minimise travel distance should the fixture be dislodged. .
10. **WARNING:** LED source become hot during use. Allow fixture to cool before servicing.
11. Do not tamper with design of fixture nor any of its safety features.
12. Tighten electrical mains cable connections regularly and replace with one of identical specification if damaged.
13. Use only with correct power supply.
14. Do not orientate the fixture towards a source of light (sun, fixture), in particular for LED versions.

VENTILATION

15. Keep well away from flammable material.
16. Not for outdoor use. Do not cover. Do not permit fixture to get wet.
17. To avoid overheating, do not obstruct air vents – **do not cover the unit.**

PLEASE NOTE

These products have been built to conform to European standards relating to professional lighting equipment. Any modification made to our products will void the manufacturers' warranty.

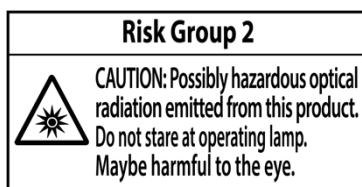

2 Presentation

2.1 Functions

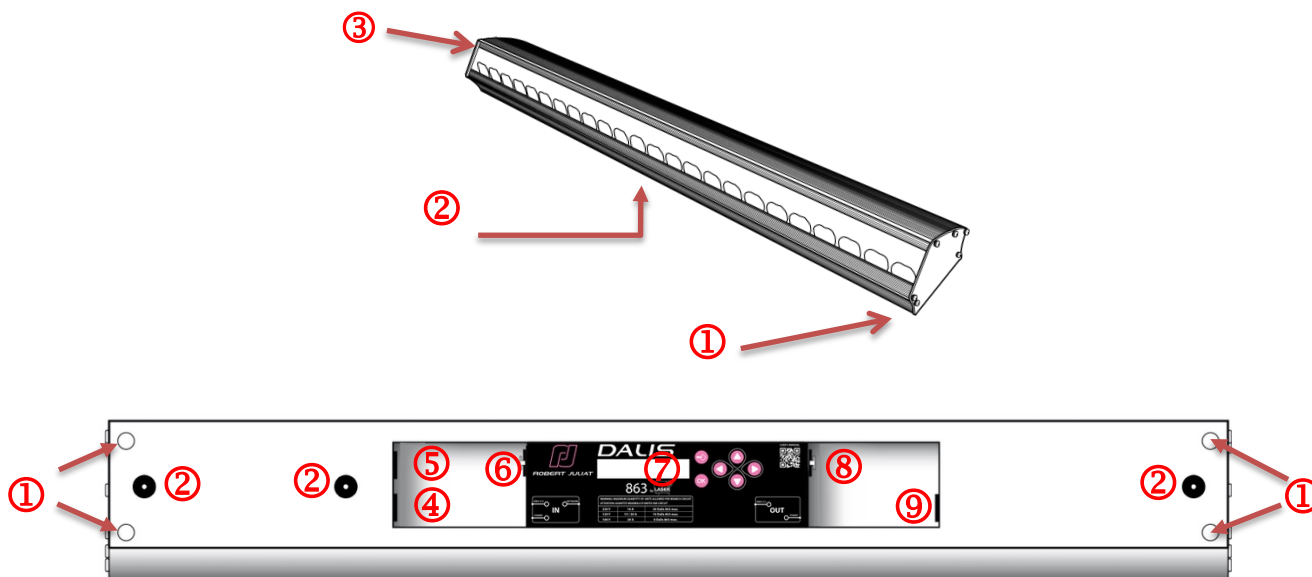

②

Functions :

- | | |
|---|---|
| <ul style="list-style-type: none"> 1. Feet 2. M10 thread for rigging 3. ID plate 4. Power IN 5. DMX IN | <ul style="list-style-type: none"> 6. Network 7. Display and keypad 8. DMX OUT 9. Power OUT |
|---|---|

2.2 Identification plate

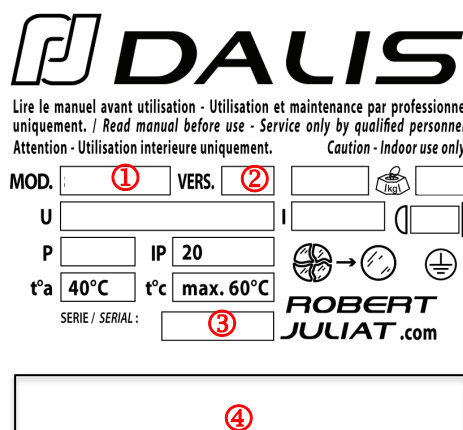
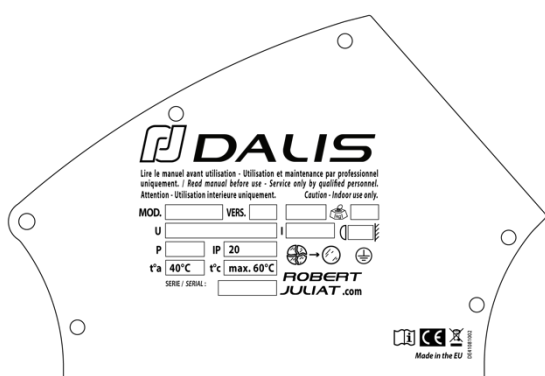

Description :

- | | |
|---|--|
| <ul style="list-style-type: none"> 1. Model 2. Version (Hardware version) | <ul style="list-style-type: none"> 3. Serial number 4. Serial number in barcode format |
|---|--|

2.3 Accessories included

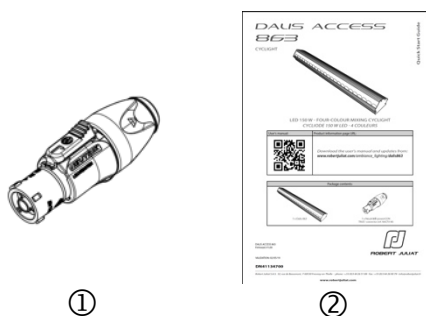

	Reference	Description
1	COU0003305	Neutrik PowerCON® True1 connector (ref. NAC3FX-W)
2	DN41134700	Quick Start manual

2.4 Optional accessories

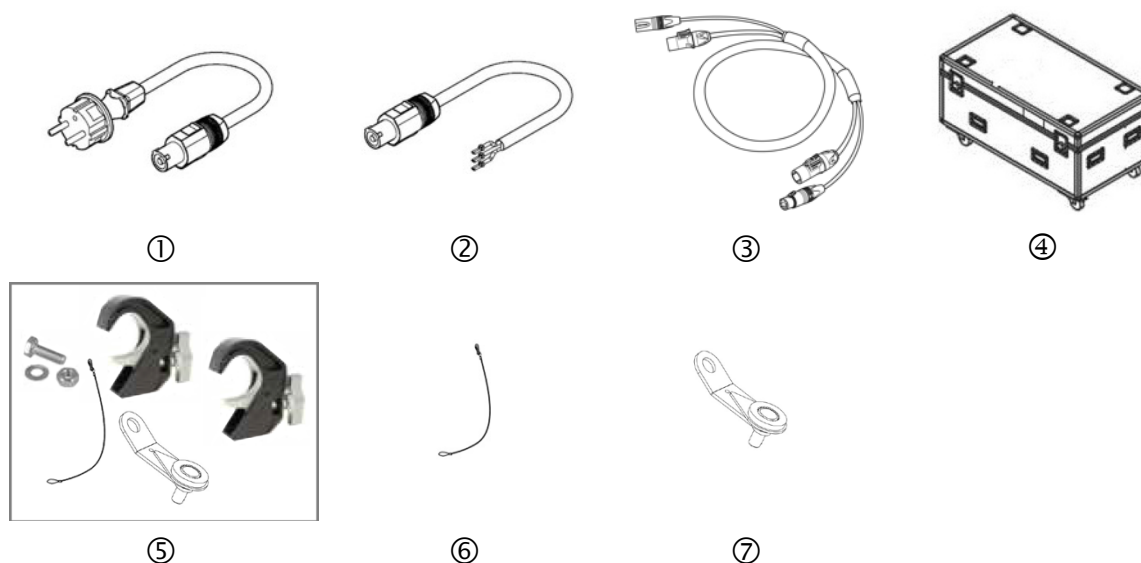

	Reference	Description
1	CAL03	3 meter power cable (3G1,5 HO7RNF) with Neutrik PowerCON® True1 and CEE 7/7 (2P+T NF/SCHUKO) connectors
2	CAL04	1,50m power cable UL/CSA with Neutrik PowerCON® connector
3	CAL05	Combined Neutrik PowerCON® True1 / DMX (5 pins) patch cable - length: 1m
4	FC860/S	Flight-case for 6 Dalis
5	AccessRig	Rigging hardware set (872 clamps x2 + screws + PECS x1 + CS2 x1)
6	CS2	Safety cable Ø3 mm L= 600mm - SWL: 75 Kg
7	PECS	Safety cable attachment point + M10 screw + nut indicator

3 Set-up

3.1 Mechanics

3.1.1 Operating positions

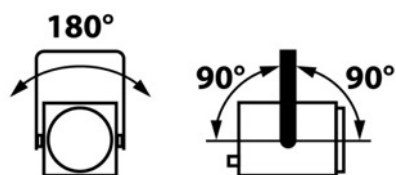

3.1.2 Minimum distance between a flammable material and the lighting unit

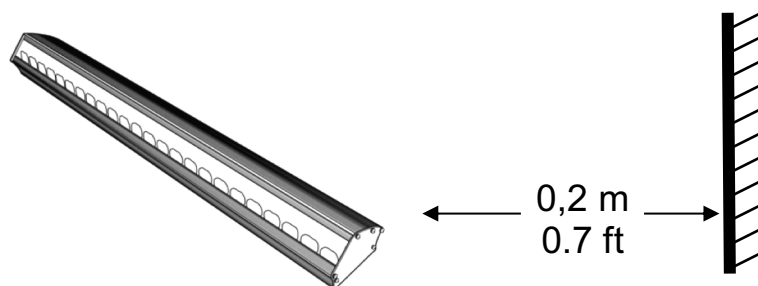

3.1.3 Instructions for use

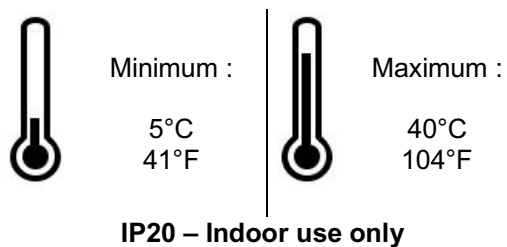

3.1.4 Floor installation

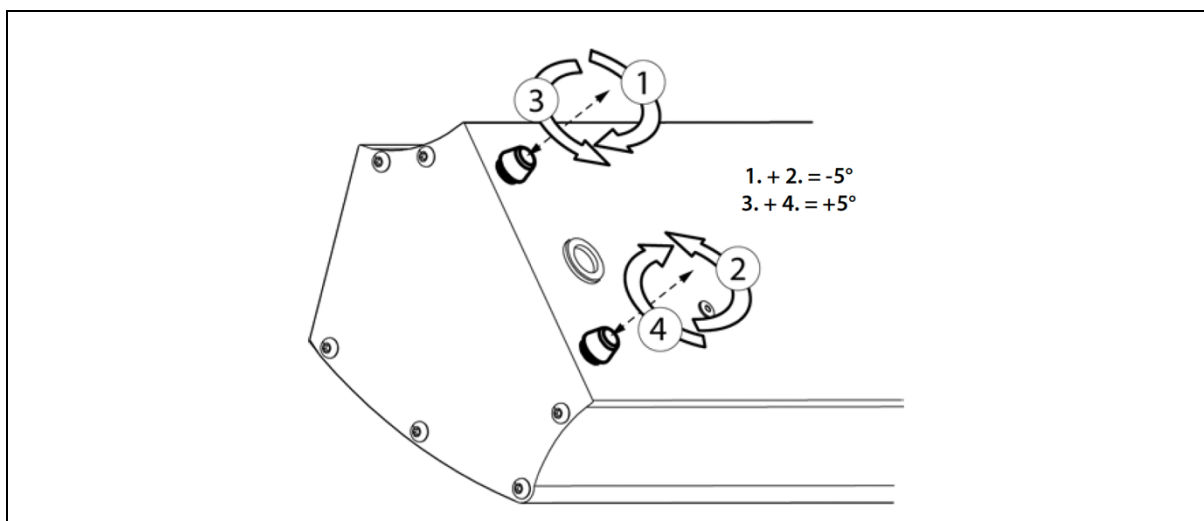

3.1.5 Installation with clamps

- The fixture can be secured with clamps by using M10 screws on the M10 threads.
- Ensure fixture is correctly mounted on an appropriate support.
- **The fixture must be installed with 2 clamps.**
- Net weight : model 863 : 9.3 Kg
- Center M10 thread can be equipped with eye bolt to attach safety cable.
- Safety cables or bonds must be securely attached to the back of the fixture and be as short as possible, or rolled up as necessary, to minimise travel distance should the fixture be dislodged.

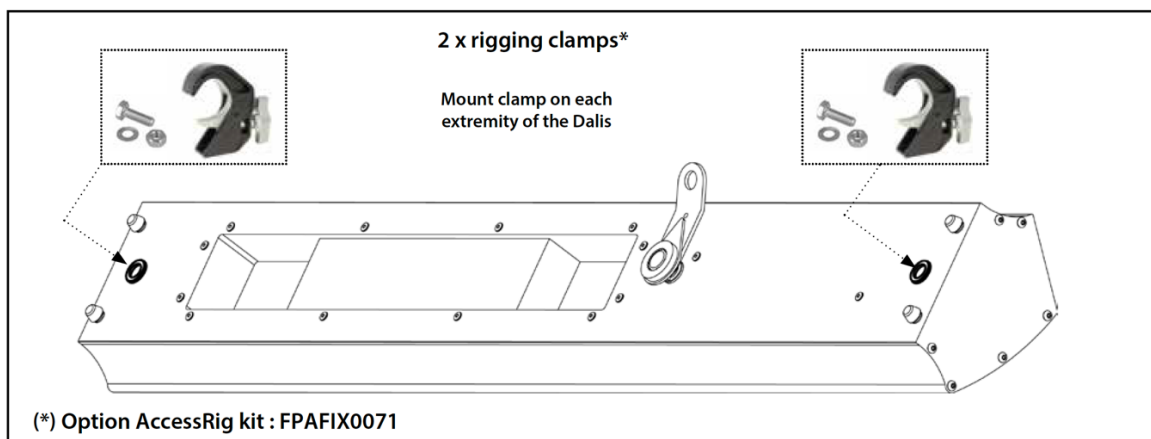

3.1.6 Safety cable.

- When hung or flown, the fixture must be secured by an additional hanging accessory (such as safety bond or cable) of suitable length.
- Safety cables or bonds must be securely attached to the back of the fixture and be as short as possible, or rolled up as necessary, to minimise travel distance should the fixture be dislodged.

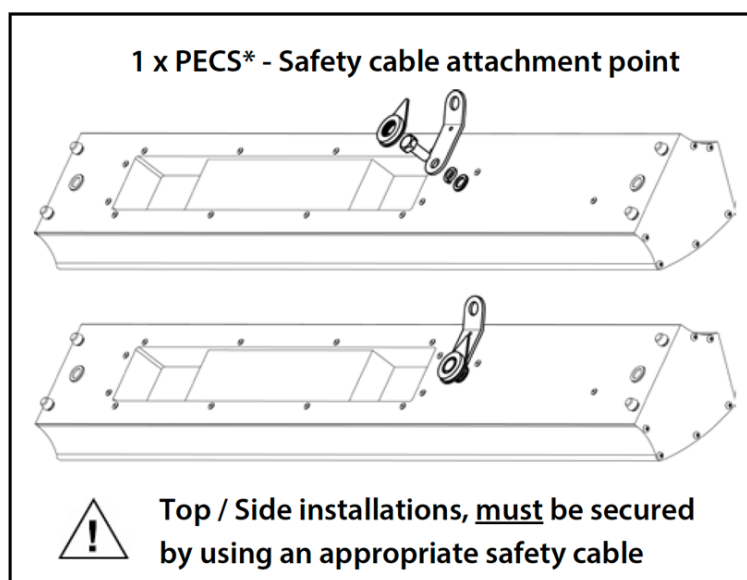

3.1.7 Angular sensor

→ selection in STATUS/ANGULAR ADJUSTMENT menu

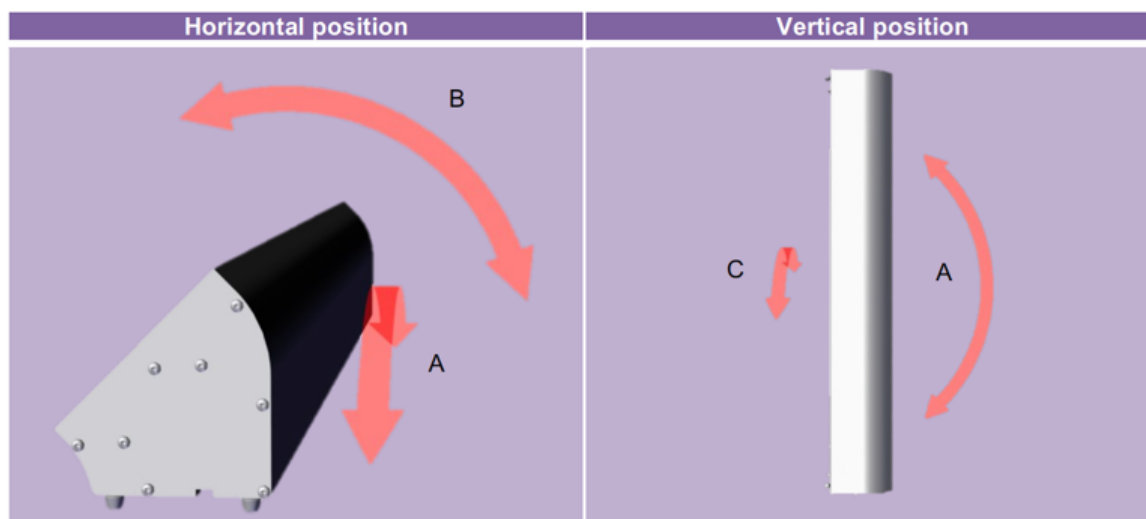
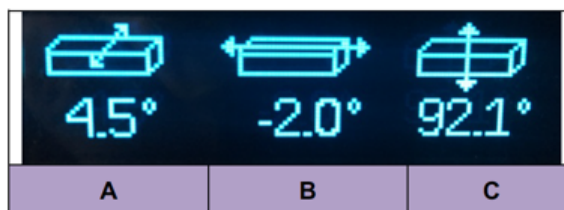

3.2 Electrical

3.2.1 Power

Model	Voltage (V)	Frequency (Hz)	Amps* (A)	PF	Power (W)	Connectors
863	230	50	0,7	0,82	133	Neutrik powerCON TRUE1 ref. NAC3FPX (max. 20A) see appendix 1 for assembly instructions
	120	60	1,2	0,93	137	
	100	60	1,5	0,93	138	



- Class 1 product. **This luminaire must be grounded.**
- Must be connected directly to AC power. **Do not connect to dimmer power.**
- Automatic power detection.
- **Daisy chain: maximum of 20 units (230V) / 10 units (120V) / 8 units (100V)**

Daisy chain (with optional patch cable):

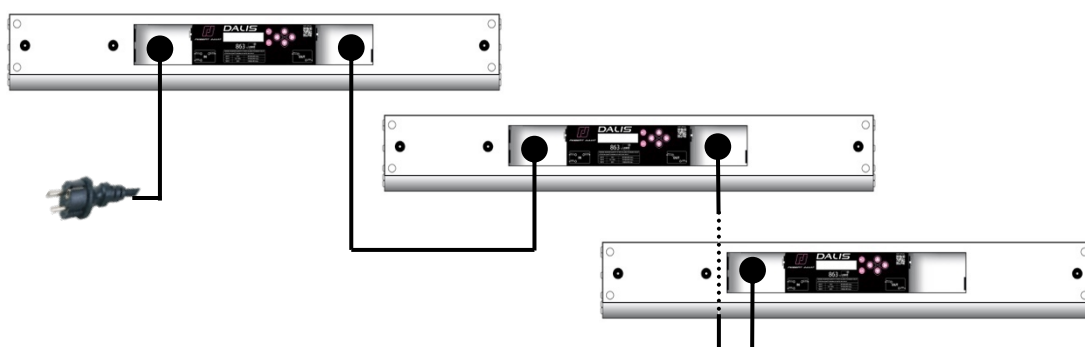

3.2.2 Power cable

Power cable

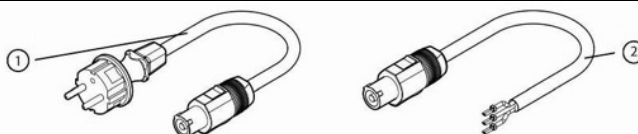

Power cable	Connector	Mains plug	Cable type	Cable length	Wiring
1 Standard version	Neutrik PowerCON® NAC3FX	CEE7/7	3G1.5 H07RNF	3 m 9.8 ft.	Live: Brown Neutral: Blue Ground: Yellow/Green
2 North American version		-	14AWG SJ TYPE (UL/CSA)	1.5 m 4.9 ft.	Live: Black Neutral: White Ground: Green

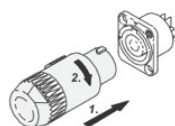

In

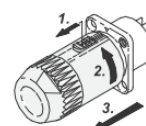

Out

3.3 DATA

3.3.1 DMX 512-A / RDM

Protocol	Input connector	Output connector
USITT DMX 512-A RDM	XLR 5-pin	XLR 5-pin

DATA connectors		
PIN #	DMX	Description
1	Shielding	Foil & Braided Shield
2	DMX (-)	1 st conductor of 1 st twisted pair
3	DMX (+)	2 nd conductor of 1 st twisted pair
4	Not used	1 st conductor of 2 nd twisted pair
5	Not used	2 nd conductor of 2 nd twisted pair

DMX OUT DMX IN

Daisy chain

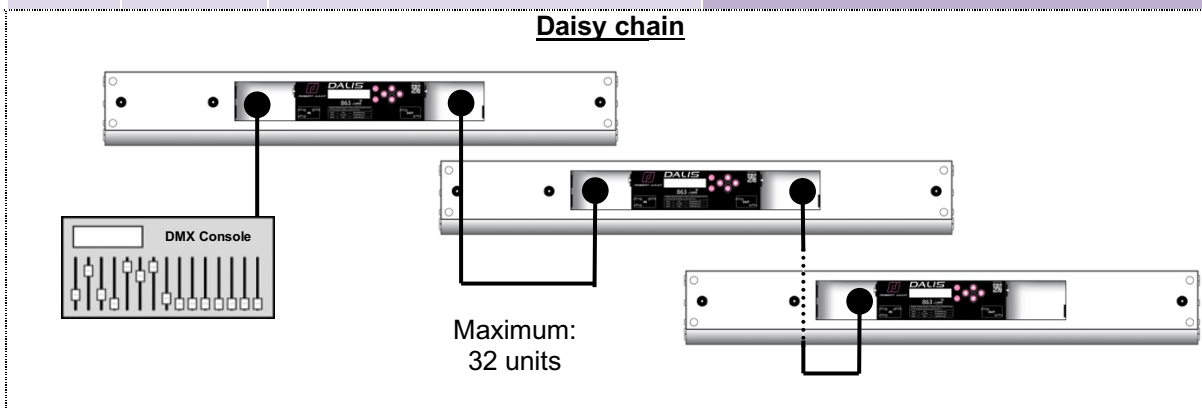

3.3.2 Art-Net / sACN

Protocol	Input connector	Output connector
Art-Net sACN	RJ45	-

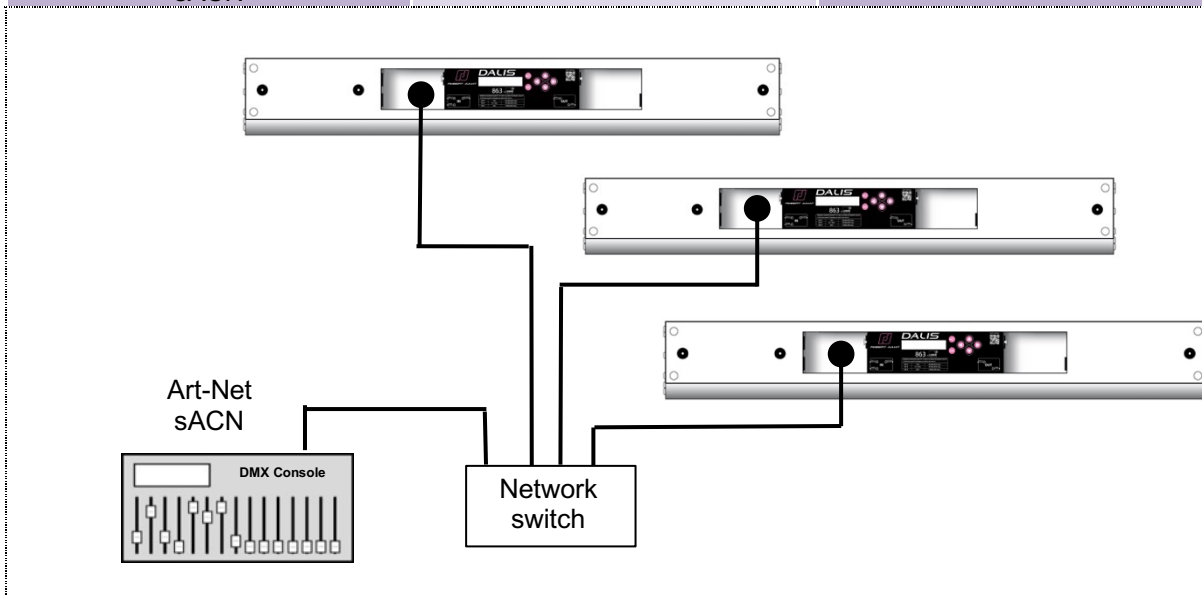

3.3.3 Ethernet/DMX node

Protocol	Input connector	Output connector
Art-Net sACN	RJ45	DMX

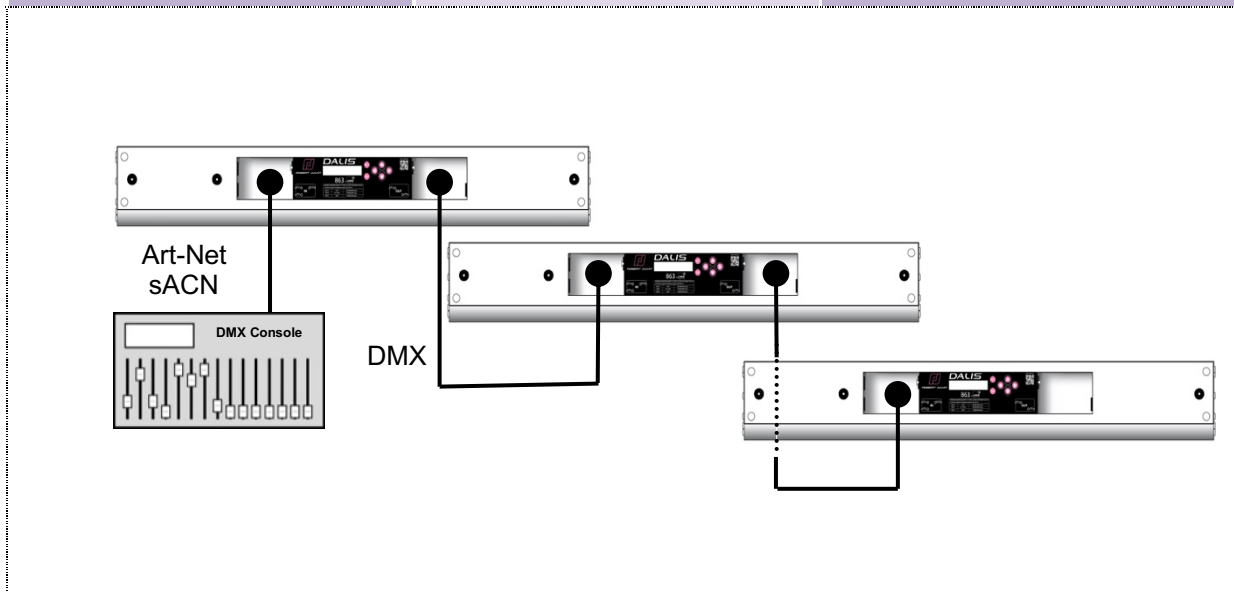

4 Operation

4.1 Light intensity

4.1.1 Range



4.1.2 Control

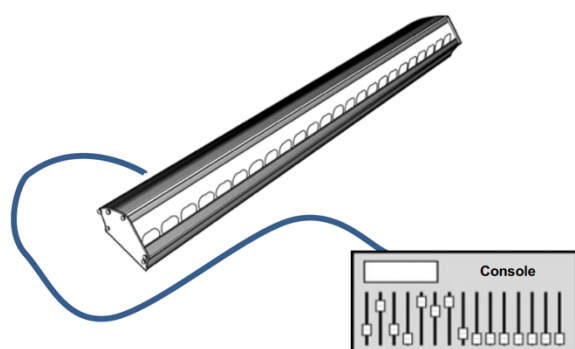

Remotely with
DMX512-A / Artnet / sACN protocols
Mode 1 – 2 – 3 – 4



Locally via STAND ALONE mode

4.1.3 Parameters

4.1.3.1 Dimming resolution

Resolution	DMX mode :
8 bits – 255 steps	3 – STAND ALONE
16 bits – 65 535 steps	1 – 2 – 4

4.1.3.2 Dimming curve

→ selection in *SETUP/DIMMER CURVE* menu: Linear or Square

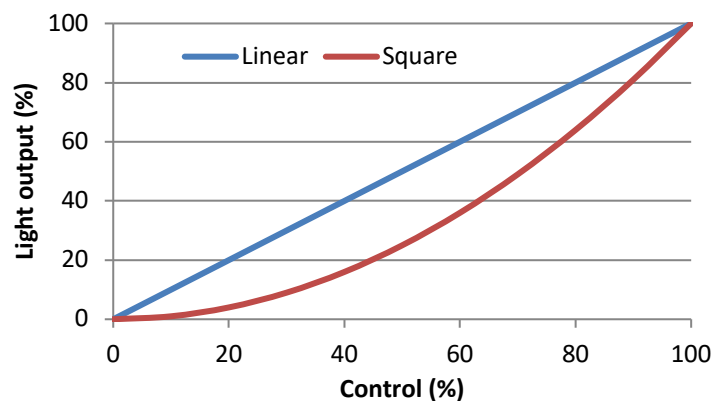

4.2 Colours

4.2.1 Range

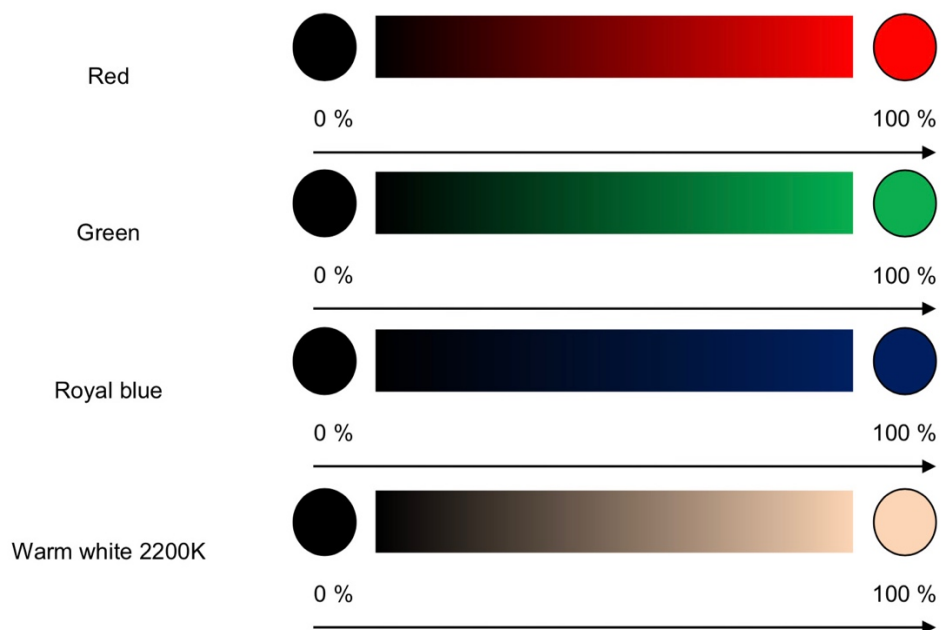

4.2.2 Control

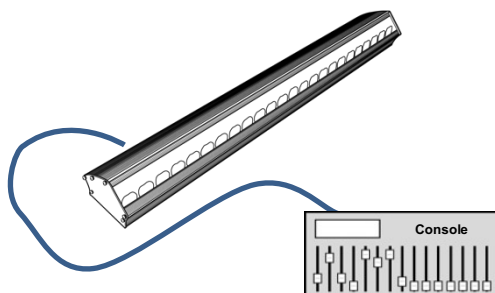

Remotely with
DMX512-A / Art-Net / sACN protocols
Mode 1 – 2 – 3 – 4

4.2.3 Parameters

4.2.3.1 Resolution

Resolution	DMX mode :
8 bits – 255 steps	3
16 bits – 65 535 steps	1 – 2 – 4

4.2.3.2 Intensity curve

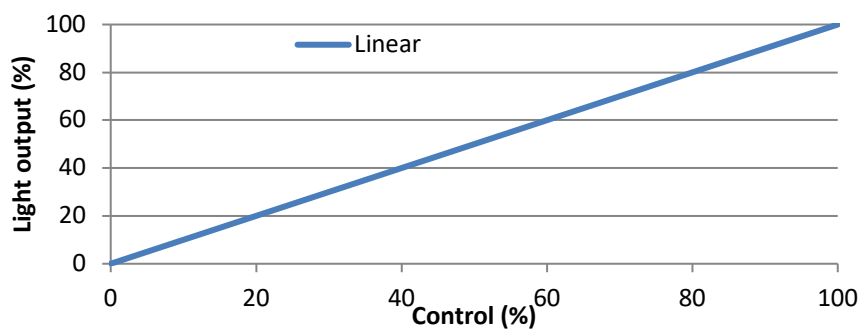

4.3 Strobe

4.3.1 Range

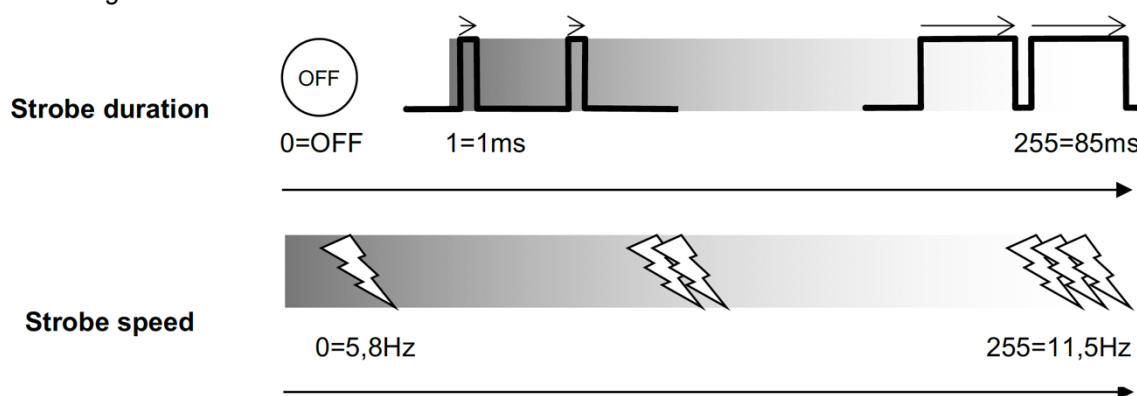

4.3.2 Control

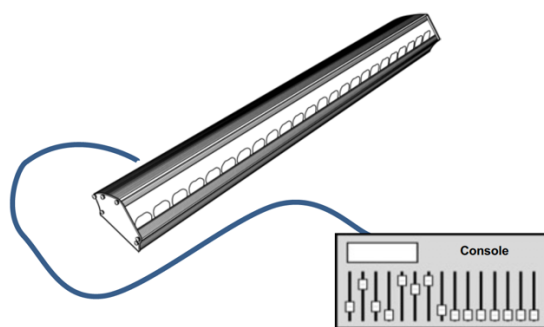

Remotely with
DMX512-A / Art-Net / sACN protocols
Mode 1 – 2 – 3

4.4 Group

4.4.1 Range

Model :	Group 4	Group 3	Group 2	Group 1
863				

4.4.2 Control

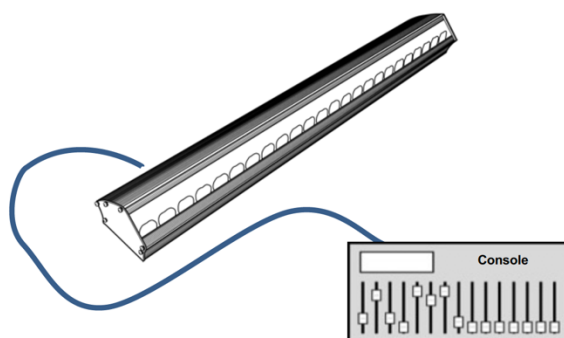

Remotely with
DMX512-A / Art-Net / sACN protocols
Mode 1 – 4

4.5 Response time

4.5.1 Range



4.5.2 Control

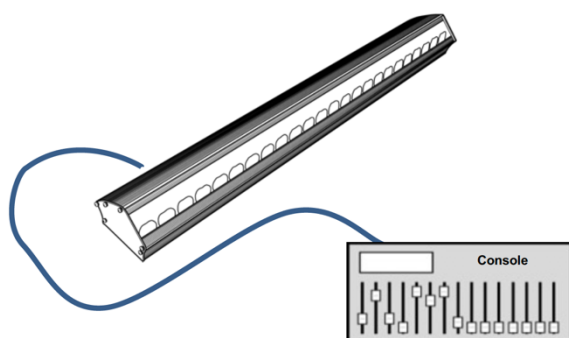

Remotely with
DMX512-A / Art-Net / sACN protocols
Mode 1 – 2 – 3

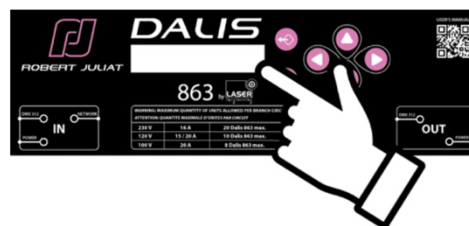

Locally only when DMX mode 4 is selected

5 Control and parameters

5.1 Local display and Controls

5.1.1 Display



	Function
	Exit the current menu option and/or go back
	Enter the current menu option and/or valid
	Scrolls through menus and/or Increase data value
	Scrolls through menus and/or Decrease data value
	Scrolls through menus and/or Increase data value
	Scrolls through menus and/or Decrease data value

5.1.2 Parameters

5.1.2.1 Display mode

→ Selection in *SETUP/DISPLAY MODE* menu

Display	Mode	Description
	Auto-OFF	Main display OFF after 20 seconds
	Always on	Main display always ON
	DATA check (dot)	Main display OFF – only a “dot” sign is visible if data detected

5.1.2.2 Display faults

→ Selection in *SETUP/DISPLAY FAULTS* menu

Display	Mode	Description
	Warn on faults	Message displayed in case of data error
	Don't warn on faults	No message in case of data error – display remains the same

5.1.3 Menus

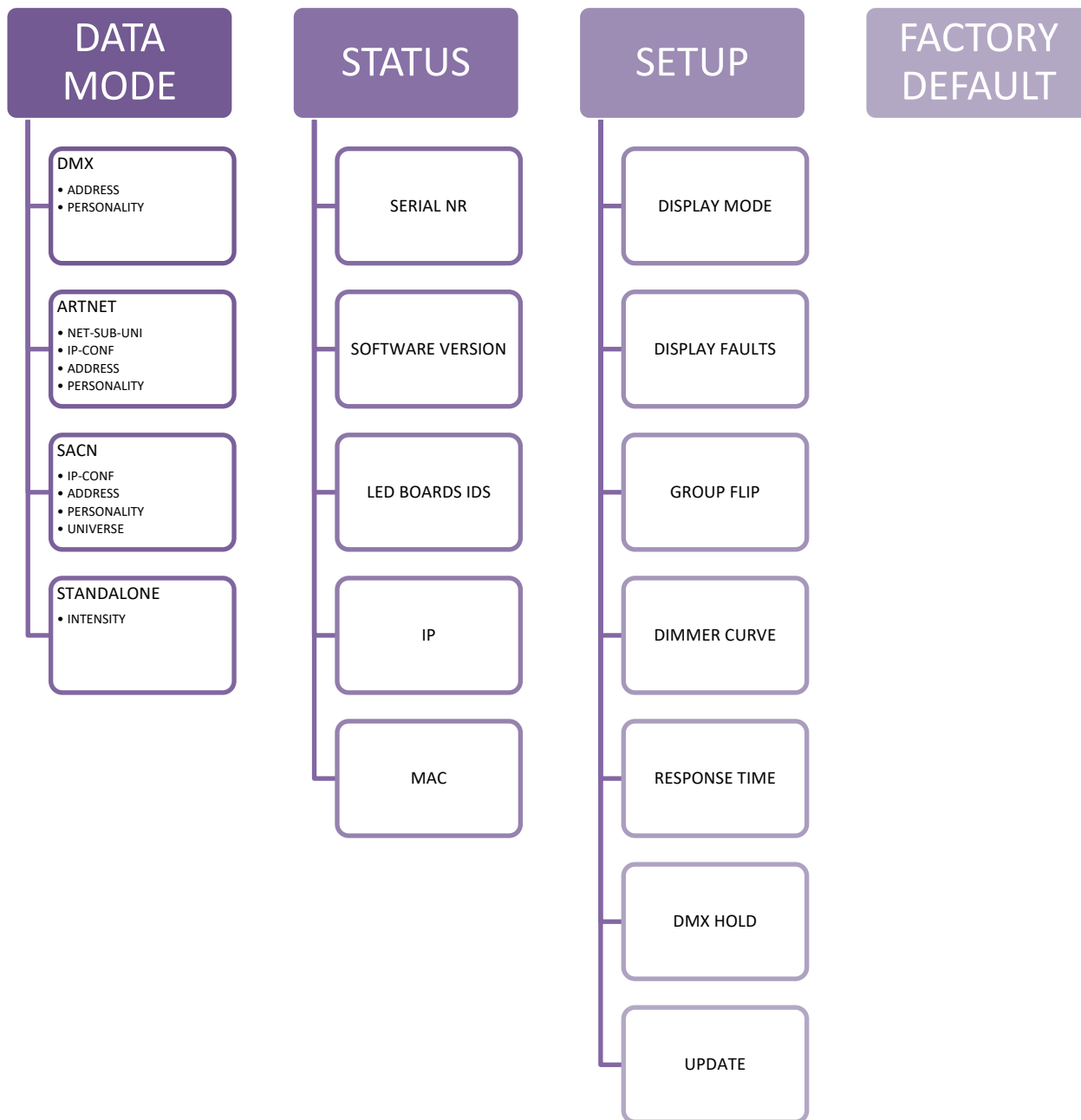

5.2 DMX512-A remote control

5.2.1 Protocol:

E1.11 – 2008, USITT DMX512-A

5.2.2 Configuration:

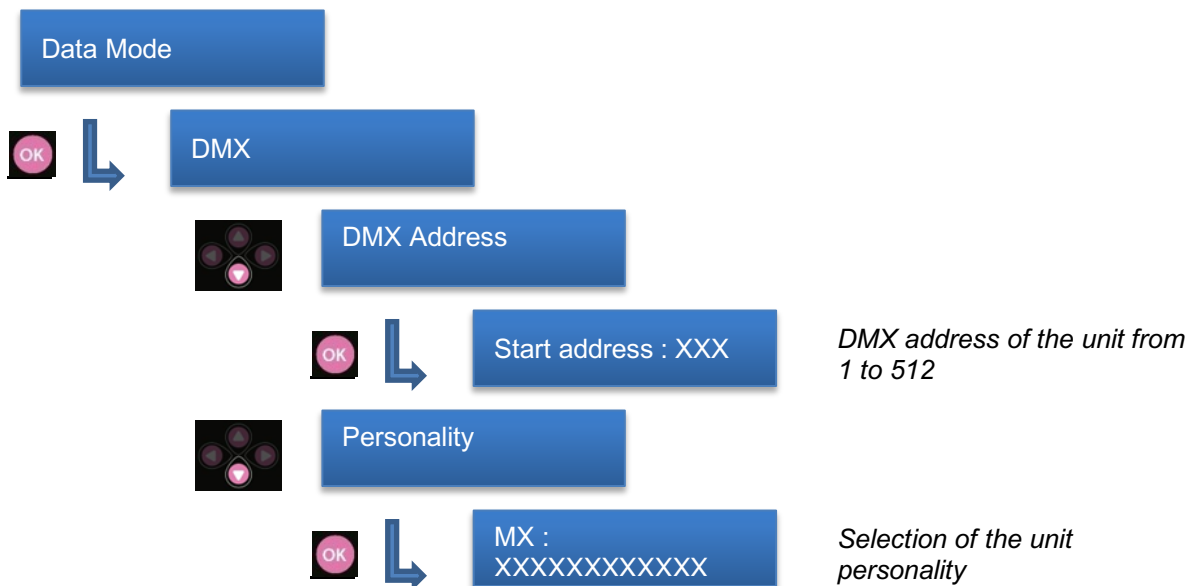

5.2.3 Parameters

5.2.3.1 DMX Hold

→ Selection in *SETUP/DMX HOLD* menu

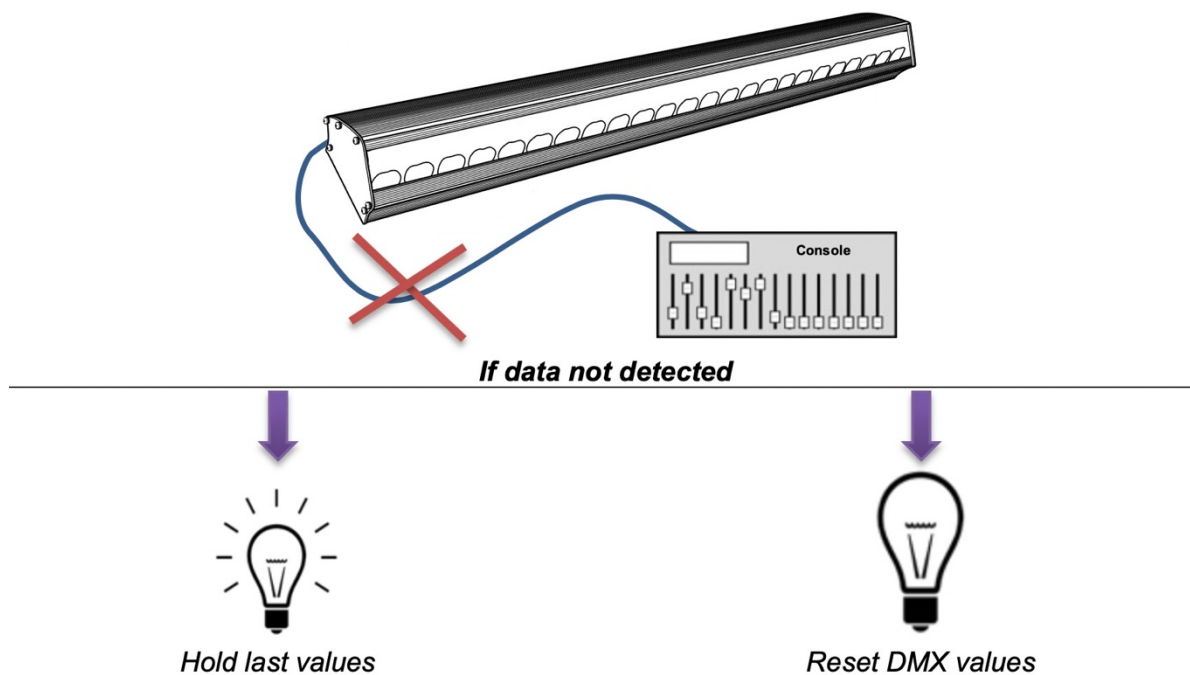

5.2.4 DMX chart:

5.2.4.1 DMX chart: model 863

DMX address	Mode 1 Full4groupsmode16b	Mode 2 Full1groupmode16b	Mode 3 Full1groupmode8b	Mode 4 4groupsindividual16b
1	Dimmer	Dimmer	Dimmer	Group 1 - Dimmer 1
2	Dimmer fine	Dimmer fine	Red	Group 1 - Dimmer fine 1
3	Group 1 - Red	Red	Green	Group 1 - Red
4	Group 1 - Red fine	Red fine	Royal blue	Group 1 - Red fine
5	Group 1 - Green	Green	Warm white	Group 1 - Green
6	Group 1 - Green fine	Green fine	Strobe duration	Group 1 - Green fine
7	Group 1 - Royal blue	Royal blue	Strobe speed	Group 1 - Royal blue
8	Group 1 - Royal blue fine	Royal blue fine	Response time	Group 1 - Royal blue fine
9	Group 1 - Warm white	Warm white	Control mode	Group 1 - Warm white
10	Group 1 - Warm white fine	Warm white fine		Group 1 - Warm white fine
11	Group 2 - Red	Strobe duration		Group 2 - Dimmer 2
12	Group 2 - Red fine	Strobe speed		Group 2 - Dimmer fine 2
13	Group 2 - Green	Response time		Group 2 - Red
14	Group 2 - Green fine	Control mode		Group 2 - Red fine
15	Group 2 - Royal blue			Group 2 - Green
16	Group 2 - Royal blue fine			Group 2 - Green fine
17	Group 2 - Warm white			Group 2 - Royal blue
18	Group 2 - Warm white fine			Group 2 - Royal blue fine
19	Group 3 - Red			Group 2 - Warm white
20	Group 3 - Red fine			Group 2 - Warm white fine
21	Group 3 - Green			Group 3 - Dimmer 3
22	Group 3 - Green fine			Group 3 - Dimmer fine 3
23	Group 3 - Royal blue			Group 3 - Red
24	Group 3 - Royal blue fine			Group 3 - Red fine
25	Group 3 - Warm white			Group 3 - Green
26	Group 3 - Warm white fine			Group 3 - Green fine
27	Group 4 - Red			Group 3 - Royal blue
28	Group 4 - Red fine			Group 3 - Royal blue fine
29	Group 4 - Green			Group 3 - Warm white
30	Group 4 - Green fine			Group 3 - Warm white fine
31	Group 4 - Royal blue			Group 4 - Dimmer 4
32	Group 4 - Royal blue fine			Group 4 - Dimmer fine 4
33	Group 4 - Warm white			Group 4 - Red
34	Group 4 - Warm white fine			Group 4 - Red fine
35	Strobe duration			Group 4 - Green
36	Strobe speed			Group 4 - Green fine
37	Response time			Group 4 - Royal blue
38	Control mode			Group 4 - Royal blue fine
39				Group 4 - Warm white
40				Group 4 - Warm white fine

5.2.5 DMX ranges:

5.2.5.1 Strobe duration

Range min	Range max	Function
0	0	Strobe OFF
1	255	Strobe ON - 1ms --> 85ms

5.2.5.2 Strobe speed

Range min	Range max	Function
0	255	Frequency: 5,8 Hz --> 11,5 Hz

5.2.5.3 Response time

Range min	Range max	Function
0	250	Dimmer timing: 0,1s --> 4 s
251	255	OFF

5.2.5.4 Control mode

Range min	Range max	Function
0	0	
1	255	RDM deactivated

5.3 RDM remote control

5.3.1 Protocol:

ANSI E1.20 – 2010 / ANSI E1.37 - 1

For more information about RDM protocol: <http://www.rdmprotocol.org/>

5.3.2 Functions:

PID	Description	Commentary	ID	UID Description	get	set
0x0002	DiscoveryMute					
0x0003	DiscoveryUnmute					
0x0050	(Get) SupportedParameters				X	
0x0060	(Get) DeviceInfo				X	
0x0070	(Get) ProductDetailIDList				X	
0x0080	(Get) DeviceModelDescription				X	
0x0081	(Get) ManufacturerLabel				X	
0x0082	(Get/Set) DeviceLabel				X	X
0x0090	(Get/Set) FactoryDefaults				X	X
0x00C0	(Get) SoftwareVersionLabel				X	
0x00E0	(Get/Set) DMX512Personality				X	
0x00E1	(Get) DMX512PersonalityDescription				X	
0x00F0	(Get/Set) DMX512StartingAddress				X	X
0x0120	(Get) SlotInfo				X	
0x0121	(Get) SlotDescription				X	
0x0200	(Get) SensorDefinition				X	
0x0201	(Get) SensorValue				X	
0x0343	(Get/Set) Curve	E1.37-1			X	X
0x0344	(Get) CurveDescription	E1.37-1			X	
0x0345	(Get/Set) OutputResponseTime	E1.37-1			X	X
0x0346	(Get) OutputResponseTimeDescription	E1.37-1			X	
0x0400	(Get) DeviceHours				X	
0x0401	(Get) LampHours				X	
0x0500	(Get/Set) Display Invert				X	X
0x0501	(Get/Set) Display Level				X	X
0x0601	(Get/Set) Tilt Invert				X	X
0x0641	(Get/Set) LockState	E1.37-1			X	X
0x0642	(Get) LockStateDescription	E1.37-1			X	
0x1000	(Get/set) IdentifyDevice				X	X

5.4 Art-Net remote control

5.4.1 Protocol: **Artistic Licence Art-Net**

For more information about RDM protocol: <http://art-net.org.uk/>

5.4.2 Configuration:

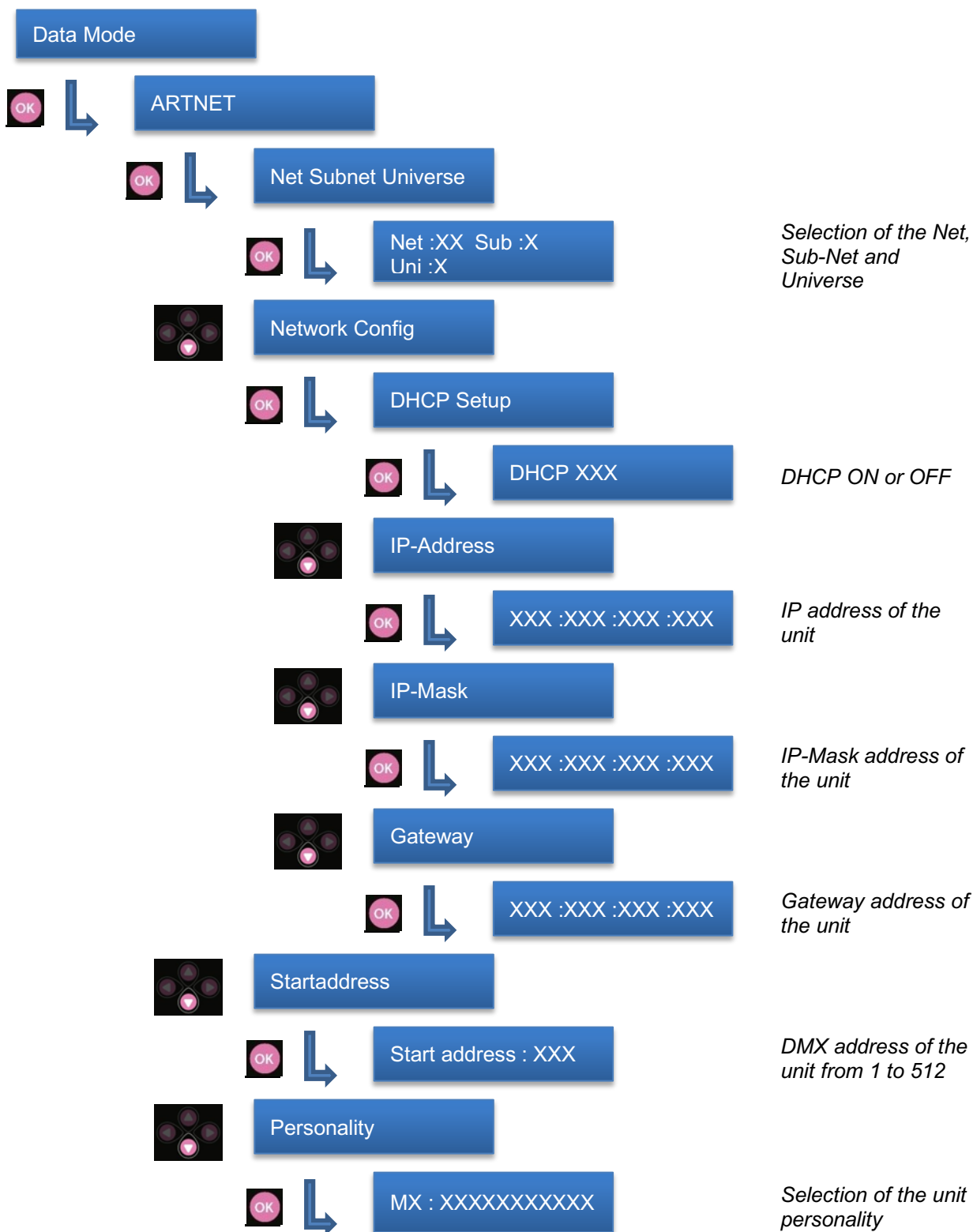

5.5 sACN remote control

5.5.1 Protocol: **ANSI E1.31 – 2009 sACN (Streaming-ACN)**

5.5.2 Configuration:

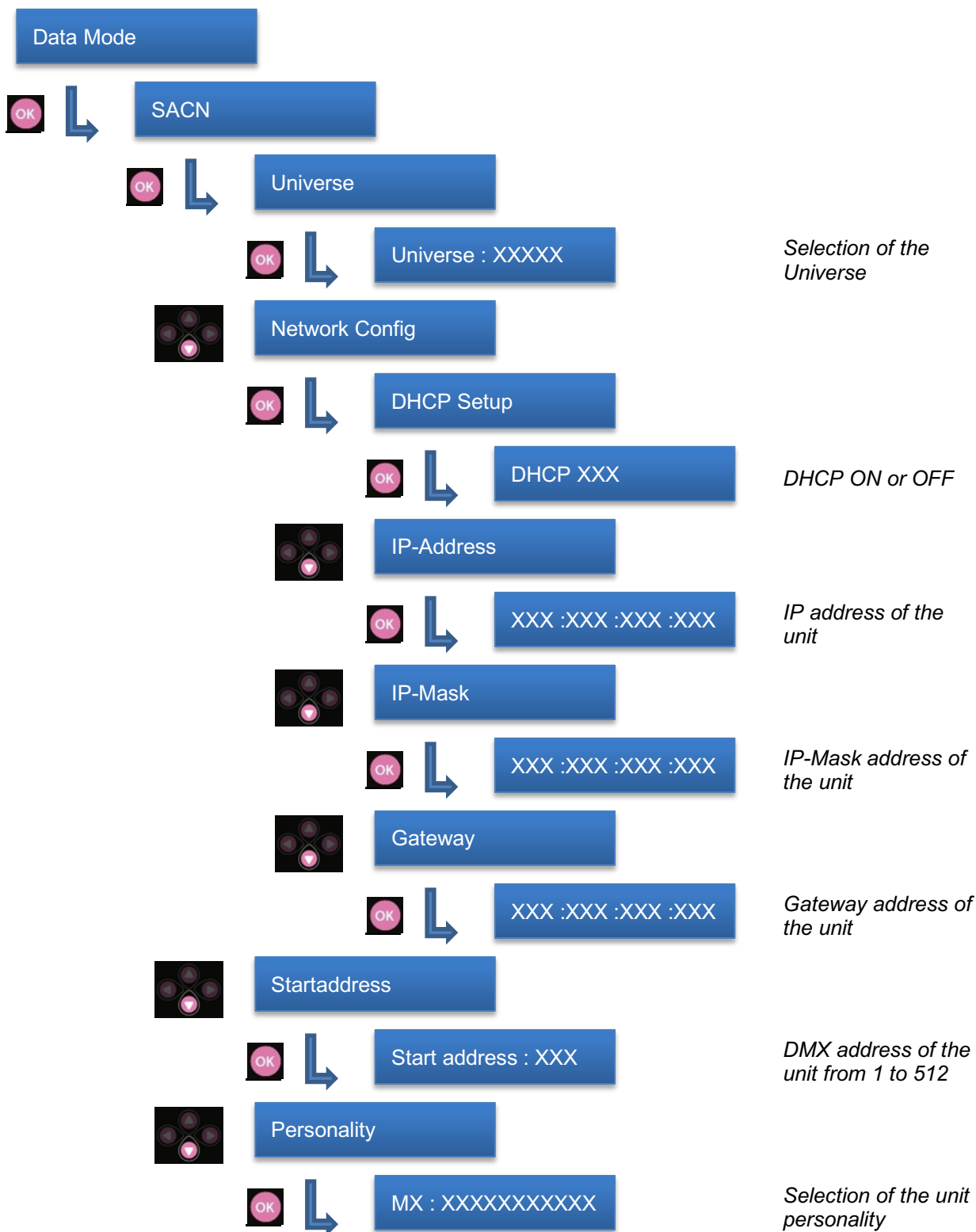

6 Service

6.1 Preventive maintenance

6.1.1 Frequency

General maintenance should be performed at least once a year or more frequently if the equipment is operated in adverse conditions (smoke, heat, humidity, touring, etc.).

6.1.2 General cleaning

Remove dust from the unit.

Front glasses can be cleaned with solutions containing alcohol.

6.1.3 General visual check

- No trace of heat.
- No loose contacts.
- No missing parts.
- Tighten mechanical assemblies (screws, bolts and nuts, etc.).

6.2 Analysis

In case of problem, contact RJ distributor with the following information:

- Model, version and serial number of the product.
- From the menu status:
 - Software version
 - LED board IDs
 - Device hours
- Description of the problem.

6.3 Electronic thermal management system

In case of overheating, light intensity will be reduced by the system. "Power reduction X%" will be shown on the display with the reducing percentage.

6.4 Firmware update

1. Firmware available on www.robertjuliat.com
2. Download and unzip the file
3. Switch on Dalis and config IP address (*DATAMODE>ARTNET>IP-CONF*):
 - a. *DHCP = OFF*
 - b. *ADDRESS = AAA.BBB.CCC.XXX*
 - c. *MASK = 255.0.0.0*
 - d. Exit to main menu to validate modifications
4. Set the Network IP of the computer :
 - a. *ADDRESS = AAA.BBB.CCC.YYY with YYY ≠ XXX*
 - b. *MASK = 255.0.0.0*
5. Connect Network from computer to Dalis, if you don't have an Auto MDI-X or a switch, use a cross link cable
6. Open a web browser (Internet Explorer, Firefox, Chrome...)
7. Enter the URL address of the Dalis: <http://AAA.BBB.CCC.XXX>
8. First, install the Main Program
 - a. *Select the firmware file dalis860_VX.XX.upd*
 - b. *Press submit button*
9. Install the Bootloader
 - a. *Select the firmware file dalis_bootloaderVX.XX_boot.upd*
 - b. *Press submit button*
10. Update message displays on Dalis display
11. When the update is completed, the Dalis shows the new firmware version

6.5 Factory defaults

Select FACTORY DEFAULT in the main menu to reset all values and parametres

APPENDIX 1



OPERATING & ASSEMBLY INSTRUCTION

NAC3FX-W | powerCON TRUE1

A. OPERATING INSTRUCTION

Application:

The powerCON TRUE1 system is certified as connector with breaking capacity according IEC 60320, VDE 0625. It is intended for use as appliance couplers and interconnection couplers. It serves to supply power to an appliance and from an appliance to another equipment. To be installed by qualified person only.

Connector Assignment:

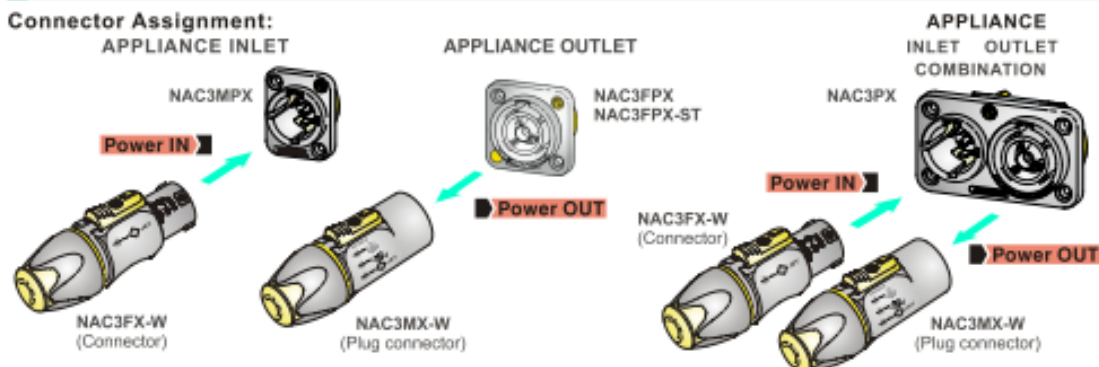

Approval based:	VDE EN 60320-1/EN60320-2-2	✓	UL UL 498 / CSA C22.2 No. 182.3	✓
Rating:	250 V ac / 16 A		250 V ac / 20 A	
Cable Type:	H05VV-F3G 1.0 mm ² , Length max. 2 m H05VV-F3G 1.5 - 2.5 mm ² H07RN-F3G 1.5 mm ²		SJTOW, SJOOW 3 x 12 AWG	
Strain Relief:	White chuck		White chuck	
Cable O.D.:	6.0 - 12.0 mm		6.0 - 12.0 mm	

B. ASSEMBLY INSTRUCTION

- A** Insert cable into the bushing and housing.
 Note: "Apply cable pulling lubricant to cable jacket."

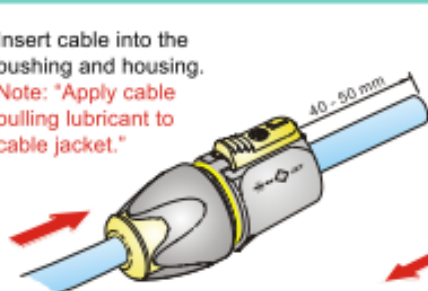

- B** Separate the housing from the bushing (cable remain in bushing)

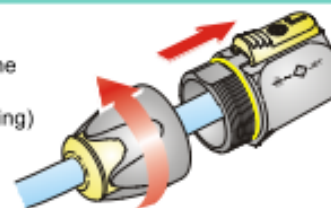

- C** Place chuck over the cable.

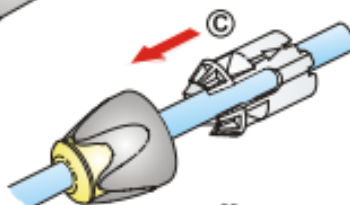

- D** Prepare cable as shown.

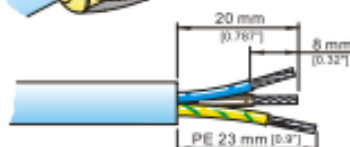

VDE (EN 60320-1/EN60320-2-2)

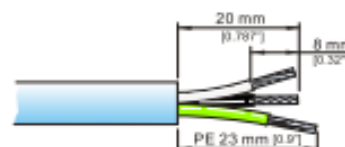

UL (UL 498 / CSA C22.2 No. 182.3)

APPENDIX 1

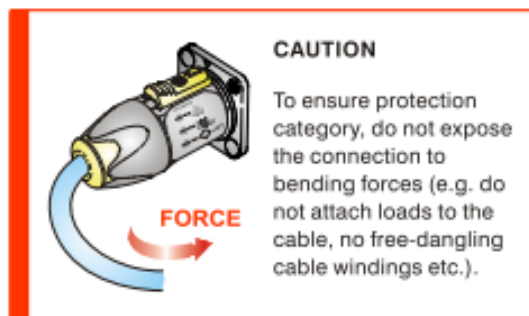
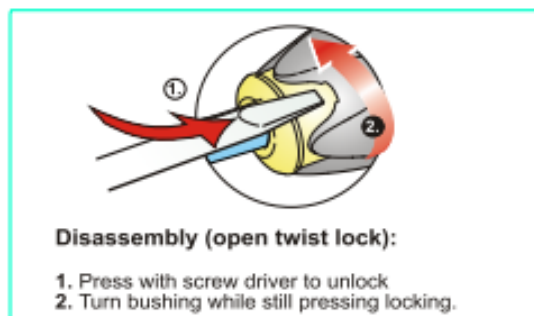
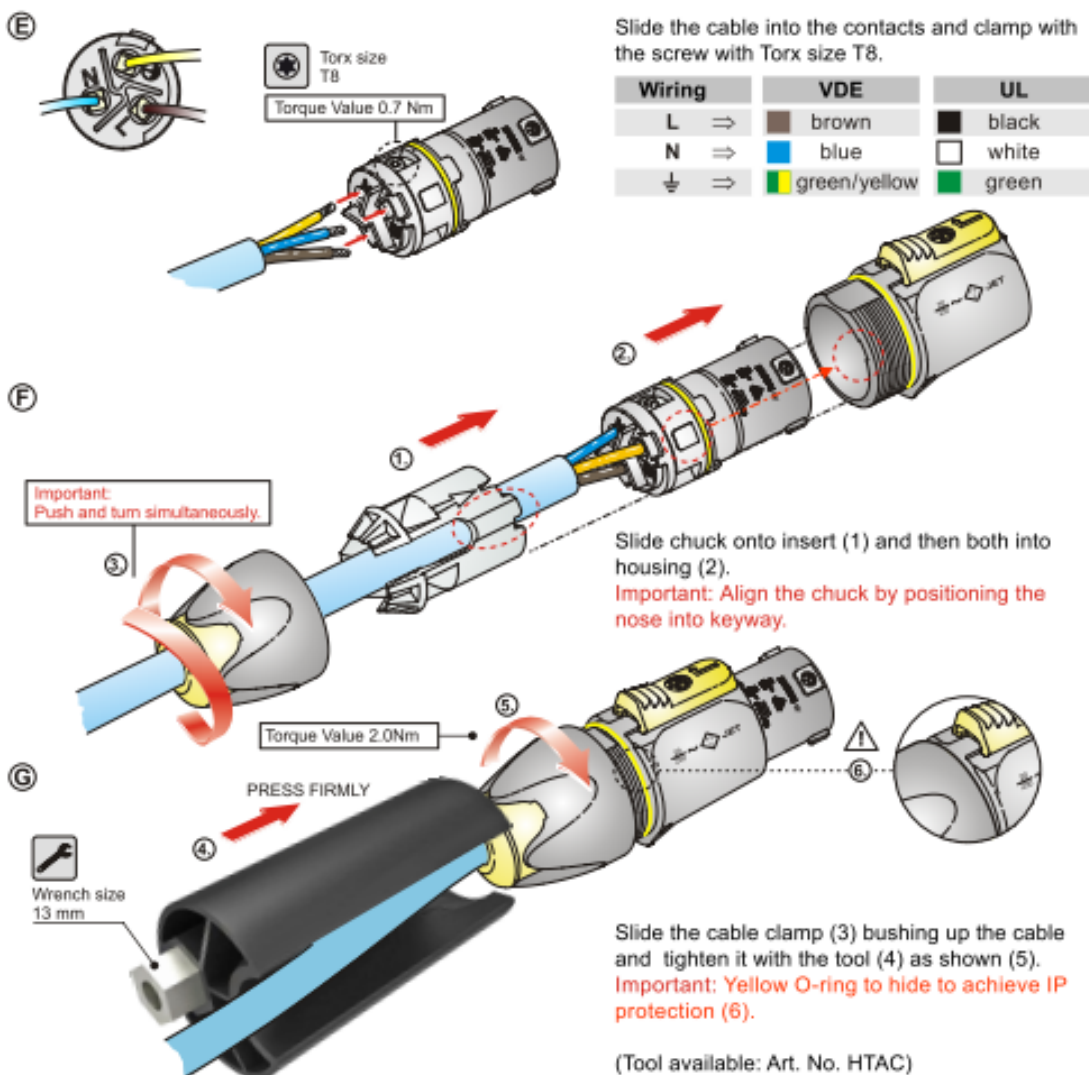
 ASSEMBLY INSTRUCTION | powerCON TRUE1

NEUTRIK AG LI T: +423/237 24 24 F: +423/232 55 99
 NEUTRIK USA Inc. USA T: +1 704/972 3050 F: +1 704/438 9202
 NEUTRIK (UK) Ltd. UK T: +44 1983/811 441 F: +44 1983/811 439
 NEUTRIK Vertriebs GmbH DE/NL/AT/DK T: +49 8131/280 890 F: +49 8131/280 830

NEUTRIK France FR T: +33 1/4131 6750 F: +33 1/4131 6511
 NEUTRIK Tokyo Ltd. JP T: +81 3/3963 4733 F: +81 3/3963 4796
 NEUTRIK Hong Kong Ltd. HK T: +852/2687 6056 F: +852/2687 6052
 NEUTRIK India Pvt. Ltd. IND T: +91/982 06 43 424 F: +91/22 26163 540

Draft. Nr.: BDA 378 | Update: 08.04.2014 | Data subject to change without prior notice. ©2014 NEUTRIK® ALL RIGHTS RESERVED. NEUTRIK® are registered trademarks.