



ACT-828 Digital Dual-Channel Receiver

ACT-848 Digital Quad-Channel Receiver

User Guide



! IMPORTANT SAFETY INSTRUCTIONS !

1. Read these instructions.
2. Keep these instructions.
3. Heed all warnings.
4. Follow all instructions.
5. Do not use this apparatus near water.
6. Clean only with a dry cloth.
7. Do not block any ventilation openings. Install in accordance with the manufacturer's instructions.
8. Do not install near any heat sources such as radiators, heat registers, stoves, or other apparatus (including amplifiers) that produce heat.
9. Do not defeat the safety purpose of the polarised or ground plug: A polarised plug has two blades with one wider than the other. The wide blade is provided for your safety. When the provided plug does not fit into your outlet, consult an electrician for replacement of the obsolete outlet.
10. Protect the power cord from being walked on or pinched particularly at plug, convenience receptacles, and the point where they exit from the apparatus.
11. Only use attachments/accessories specified by the manufacturer.
12. Use only with a cart, stand, tripod, bracket, or table specified by the manufacturer, or sold with the apparatus. When a cart is used, use caution when moving the cart/apparatus combination to avoid injury from tip-over.
13. Unplug this apparatus during lightning storms or when unused for long periods of time.
14. Refer all servicing to qualified service personnel. Servicing is required when the apparatus has been damaged in any way, such as power-supply cord or plug is damaged, liquid has been spilled or objects have fallen into the apparatus, the apparatus has been exposed to rain or moisture, does not operate normally, or has been dropped.
15. To reduce the risk of fire or electric shock, do not expose this apparatus to rain or moisture.
16. Apparatus should not be exposed to dripping or splashing and no objects filled with liquids, should be placed on the apparatus.
17. Use only with the battery which specified by manufacturer.
18. The power supply cord set is to be the main disconnected device.



WARNING

1. FOR OUTDOOR USE:

To reduce the risk of fire or electric shock, do not expose this apparatus to rain or moisture.

2. UNDER WET LOCATION:

Apparatus should not be exposed to dripping or splashing and no objects filled with liquids, such as vases should be placed on the apparatus.

3. SERVICE INSTRUCTIONS:

CAUTION - These servicing instructions are for use by qualified service personnel only. To reduce the risk of electric shock, do not perform any servicing other than that contained in the operating instructions unless you are qualified to do so.



This symbol indicates that dangerous voltage constituting a risk of electric shock is present within this unit.



This symbol indicates that there are important operating and maintenance instructions in the literature accompanying this unit.

IC-ID

This device complies with RSS-310 of Industry Canada. Operation is subject to the condition that this device does not cause harmful interference.

FCC

THIS DEVICE COMPLIES WITH PART 15 OF THE FCC RULES OPERATION IS SUBJECT TO THE FOLLOWING TWO CONDITIONS:

- (1) This device may not cause interference.
- (2) This device must accept any interference, including interference that may cause undesired operation of the device. This equipment complies with FCC RF radiation exposure limits set forth for an uncontrolled environment.

Disposal

Dispose of any unusable devices or batteries responsibly and in accordance with any applicable regulations.



2005-08-13

Disposing of used batteries with domestic waste is to be avoided!

Batteries / NiCad cells often contain heavy metals such as cadmium(Cd), mercury(Hg) and lead(Pb) that makes them unsuitable for disposal with domestic waste. You may return spent batteries/ accumulators free of charge to recycling centres or anywhere else batteries/accumulators are sold.

By doing so, you contribute to the conservation of our environment!

I. Part Names, Fig. 1

1. ACT-828 Dual-Channel

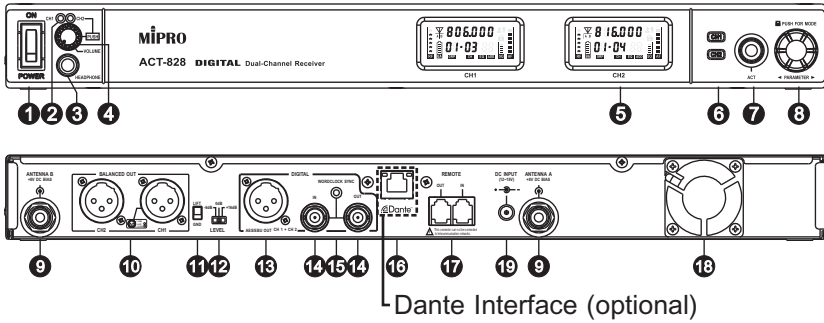

2. ACT-848 Quad-Channel

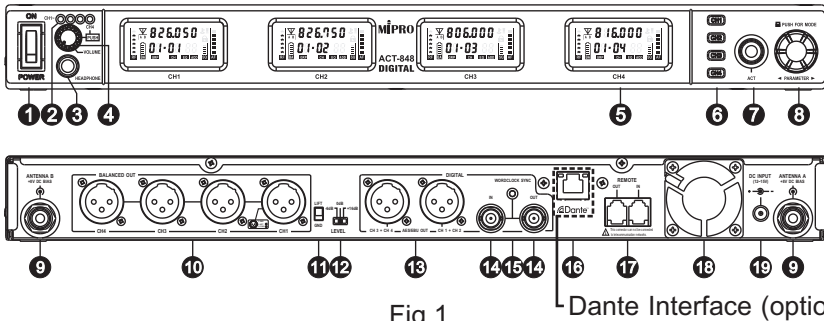

Fig.1

- ❶ Power Switch.
- ❷ Channel Indicator.
- ❸ Headphone Monitor Jack.
- ❹ Volume Control & Channel Select Knob for Headphone.
- ❺ Color VFD Screen.
- ❻ Channel Selection Button.
- ❼ ACT Sync Button.
- ❽ Rotary Knob.

- 9 B/A Antenna Connector.
- 10 Mixed Balanced Audio Output XLR Connector.
- 11 GND LIFT/GND Switch: Switch to GND, ground pin 1 of all the XLR connector. Switch to LIFT, lifts ground pin 1 of all the XLR connector. (default to GND)
- 12 Volume Level Switch: -6dB, 0dB, +16dB, selectable.
- 13 Balanced Digital Signal Output Connector: 3 pin XLR type for AES / EBU connection.
- 14 WORDCLOCK sync input/output BNC Connector: TTL, 32kHz - 96kHz.
- 15 WORDCLOCK sync input indicator.
- 16 Dante Interface (optional).
- 17 Network Interface Connector.
- 18 Cooling Fan.
- 19 DC Input Jack: the center electrode connects positive voltage.

Warning: Avoiding Hearing Damage –

Permanent noise-induced hearing loss may occur on prolonged exposure to loud sounds wearing earphones or headphones.

We recommend you listen responsibly by limiting the amount of time that you use earphones or headphones at high volume.



To prevent possible hearing damage, do not listen at high volume levels for long periods.

II. Receiver Installation, Fig. 2

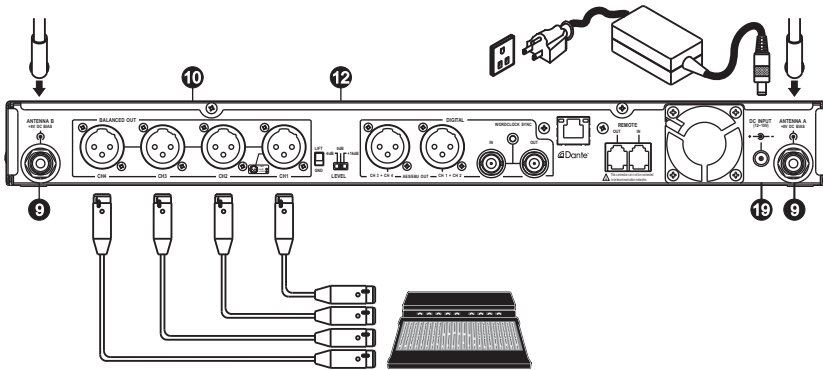

Fig. 2

1. Connect an antenna to each antenna connector ⑨ on the rear panel.
2. Power Connection: Connect the power supply to the DC input jack ⑲ and plug the other end into an AC power source.
3. Audio Output Connection:
 - (A) Each channel signal output can be connected to the mixer or amplifier's MIC IN jack by using a cable with balanced XLR connector, Fig. 2.
 - (B) 3-pin XLR output wiring diagram, as Fig. 3 shows.

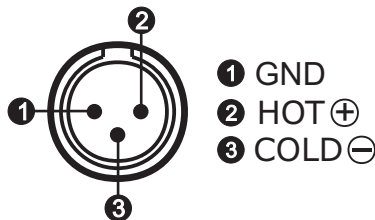



Fig. 3

- (C) Using a cable with one end XLR plug, one end 6.3 Ø phone plug, connects to LINE IN jack of a mixer or amplifier. Switch the Volume Level Switch  to +16dB.
 - (D) When audio output is connected to MIC IN jack of a mixer or amplifier, switch the Volume Switch  at 0dB. When connected to LINE IN, switch to +16dB. Switch to -6dB if the maximum output volume of an amplifier is distorted.
4. Antenna Connection: antenna connectors provide 8-volt DC bias to work with MIPRO antenna boosters. If the antenna cable is longer than 10 meters, it is recommended to add an antenna booster to ensure optimal reception.

III. Receiver Operation

1. Before turning on the receiver, ensure all transmitters are powered off and the mixer or amplifier's volume control is minimized. When the receiver is turned on and the VFD screen glows, it is working normally.
2. RF meter level glows when transmitter is powered on. Once audio signal is received from the transmitter, the AF audio meter level glows in accord with signal strength. System is abnormal if RF indicator or AF meter does not glow, then adjustment or repair might be required.
3. The microphone volume is adjusted at the amplifier or mixer. No adjustment needed at the receiver.

IV. Tips for Receiver Installation

1. Receivers can be installed on an EIA standard 19-inch rack case, Fig. 4.

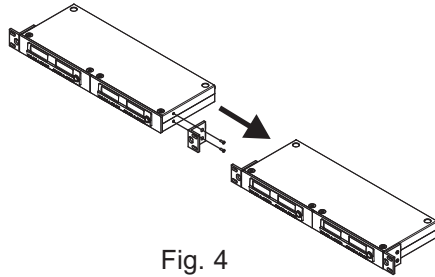

Fig. 4

2. Rack mount kit (optional), Fig. 5.

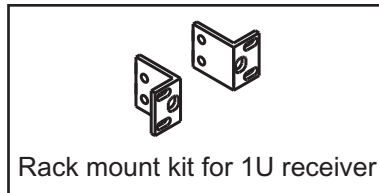

Fig. 5

3. For improving reception, an optional rear-to-front antenna cable installation through rackmount screw holes is highly recommended, Fig. 6.
4. For improving reception range, install the receiver at least 1 meter above the ground and away from EMI / RFI “noise” sources. In addition, place the transmitter at least 1 meter away from the receiving antenna, Fig. 7.

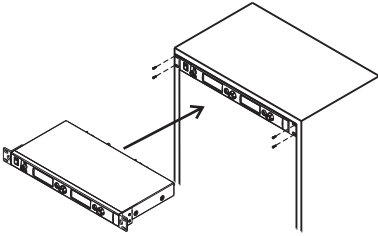

Fig. 6

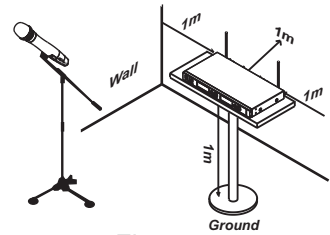

Fig. 7

5. Proper installation of antennas enhances the operating efficiency of receiver. The most important rule is to minimize the distance between the receiving antenna and transmitter for best reception quality.
6. Use MIPRO's antennas to ensure proper receiving sensitivity.
7. Antenna connector provides 8V DC bias output. Short circuits should be avoided.
8. Install MIPRO's directional antennas and boosters if extended reception distance is required.
9. Use the antenna distributor in the multiple channel wireless systems to simplify the antenna installation and improve receiving efficiency.
10. For multiple compatible systems operation, it is recommended to select MIPRO's factory preset interference-free channels within the same group to ensure optimum performance.

V. VFD Screen Description

1. VFD Screen displays functions and parameters, Fig. 8:

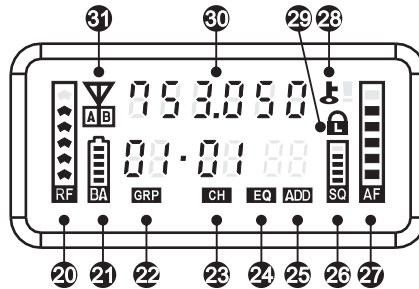

Fig. 8

- | | |
|--------------------------------|---------------------------|
| ⑳ RF Signal Meter. | ㉔ Squelch Meter. |
| ㉑ Battery Meter. | ㉕ Audio Signal Meter. |
| ㉒ Group Cursor. | ㉖ Encryption Status Icon. |
| ㉓ Channel Cursor. | ㉗ Panel Lock Icon. |
| ㉔ Equalizer and Anti-feedback. | ㉘ Working Frequency. |
| ㉕ PC Address Cursor. | ㉙ Diversity A/B Antenna. |

2. Lightening VFD Screen, Fig. 9:

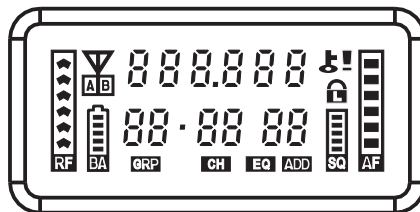

Fig. 9

3. The Functions and Parameters:

Use Rotary Knob ⑧ to set functions through the VFD Screen.

8 functions can be programmed, Fig. 10.

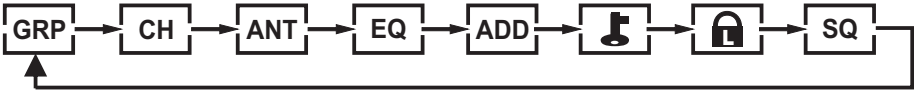
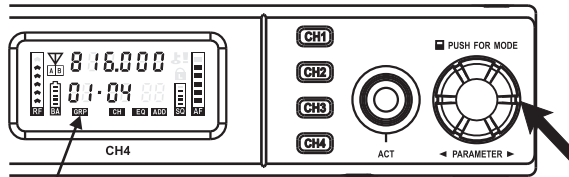

Fig.10

4. Programmable Parameters:

(A) GROUP Setting, Fig. 11:



GRP cursor

Turn knob right to increase a GRP number

Turn knob left to decrease a GRP number

Fig. 11

- (1) Press the rotary button to select parameters. GRP cursor blinks to denote it can be changed readily.
- (2) Turn the knob right to increase or left to decrease a GRP number.
- (3) Press the knob again, GRP number stops blinking and saves the new group number automatically.

(B) CHANNEL Setting, Fig. 12:

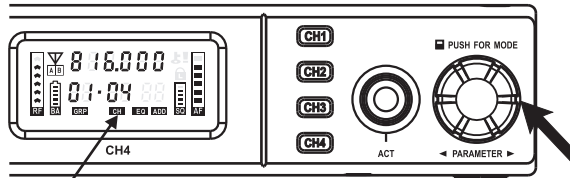

CH cursor

Turn knob right to increase a CH number

Turn knob left to decrease a CH number

Fig. 12

- (1) Press the rotary button to select parameters. Current CH number blinks to denote it can be changed readily.
- (2) Turn the knob right to increase or left to decrease a CH number.
- (3) Press the knob again, CH number stops blinking and saves the new channel number automatically.
- (4) When SQ meter shows full-grid, it will enter CH selection forcibly.
- (5) Group 16 enables the user to select and save up to 16 frequencies.
 - (a) When GRP shows 16, CH cursor starts blinking. Press the knob to enter frequency setting. Current frequency number blinks to denote the parameter can be changed readily.
 - (b) Turn the knob right to increase or left to decrease a FRQ number.
 - (c) The frequency value is programmed by 1MHz and 25kHz step.
 - (d) After changing the parameter, press the knob again, FRQ number stops blinking and saves the new frequency value automatically.
 - (e) Only frequencies in group 16 can be programmed. Other groups cannot be programmed.

(C) ANTENNA Setting, Fig. 13:

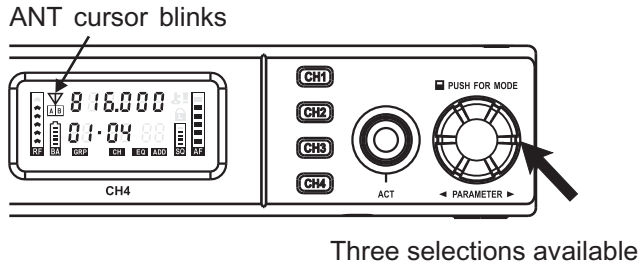

Fig. 13

- (1) Factory default is set at Automatic switching antenna status. Antenna A or B settings can be programmed.
- (2) Press rotary knob to select ANT cursor. ANT cursor blinks to denote it is ready to accept parameter changes. Press and hold knob for 2~3 seconds until ANT cursor blinks again. Turn knob left or right to select either Antenna A or Antenna B or Automatic antenna setting, Fig.14.



Fig. 14

- (3) Under manual setting, press knob again exits the manual setting or system reboot, system will automatically switch back to Automatic switching antenna setting.
- (4) Antenna A or B setting is provided only for testing and analyzing RF strength of either antenna side during system installation. We highly recommend restoring the setting back to Automatic switching once done with testing.

(D) EQUALIZER Setting, Fig. 15:

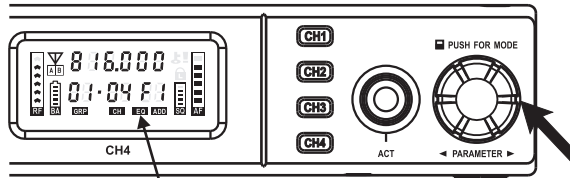

EQ cursor blinks

Turn knob right to increase a number
Turn knob left to decrease a number

Fig. 15

First digit F denotes anti-feedback feature is activated

First digital 0 denotes anti-feedback feature is not activated

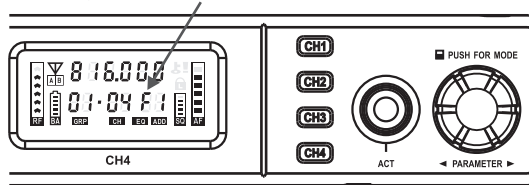
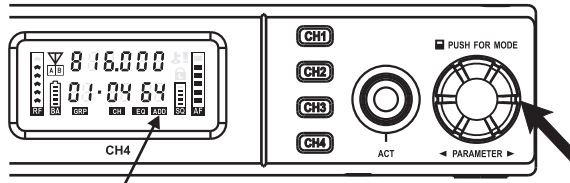

Fig. 16

- (1) Press knob to EQ cursor. EQ cursor blinks to denote it is ready to accept parameter changes.
- (2) Turn knob right to increase or left to decrease a number.
- (3) First digit F and 0 will be displayed during knob turning. F denotes anti-feedback feature is activated. 0 denotes anti-feedback feature is not activated.
- (4) Preset EQs enable usage of the same microphone capsule for different equalization to suit artists' preferences and stages.
- (5) EQ will automatically be set to EQ-09 when interfaced with a PC computer. Receiver will transfer the 32 parameters to EQ-09 from PC computer.

(E) PC ADDRESS Setting, Fig. 17:



ADD cursor

Turn knob right to increase an ADD number
Turn knob left to decrease an ADD number

Fig. 17

- (1) Receiver has ACT-BUS interface. Install MIPRO hardware and software for PC remote-control and monitoring up to 64 MIPRO receiver channels simultaneously.
- (2) Address numbers need to be pre-programmed in advance from 01 ~ 64 before interfacing for network monitoring and control. However, to ensure networking is working properly, all address numbers need to be different from each other to avoid address conflicts.
- (3) Press the rotary knob to select parameters. Add cursor blinks to denote it can be changed readily.
- (4) Turn the knob right to increase or left to decrease a new address number.

(F) **🔒** : ENCRYPTION Setting, Fig. 18

Y E 5 denotes receiver is encrypted

no denotes receiver is not encrypted

Encryption key blinks

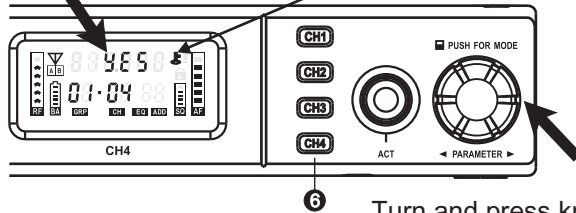

Turn and press knob to activate or deactivate encryption

Fig. 18

- (1) Press channel selection button **6** to set up the encryption status for each channel.
- (2) Encryption Set-up: Press knob to select **🔒** cursor. **🔒** cursor blinks to denote it is ready to accept parameter changes. Press and hold knob for 2~3 seconds until "Y E 5" & "no" appears interchangeably. "Y E 5" blinks together with **🔒** cursor. "no" blinks without **🔒** cursor.
- (3) ** Whenever encryption status is changed, press ACT button again to send new encryption key to transmitter. **
- (4) The transmitter can only display encryption status. To activate/deactivate encryption on the transmitter, user must program from receiver and use ACT function to complete the setup.
- (5) The newly encrypted transmitter will work only with the last encrypting receiver and will not work with other receiver even with the same frequency as there will be no audio output.
- (6) The encryption key is randomly generated; hence, a new, secure, encryption key is also downloaded to a transmitter each time an ACT function is synced successfully.

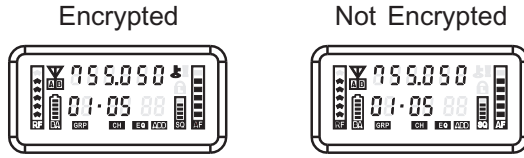
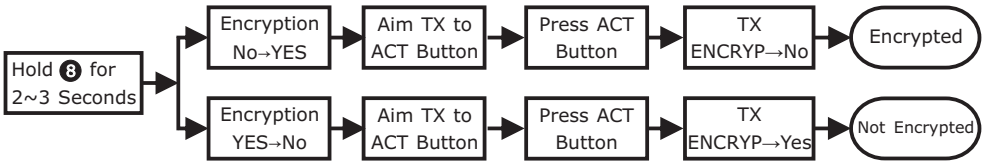





Fig. 19

Encryption Set-up Flow Chart



(G)  : Lock & Unlock Receiver Panel, Fig. 20

 $\square n$ denotes panel will be locked

 $\square FF$ denotes panel will not be locked  icon blinks

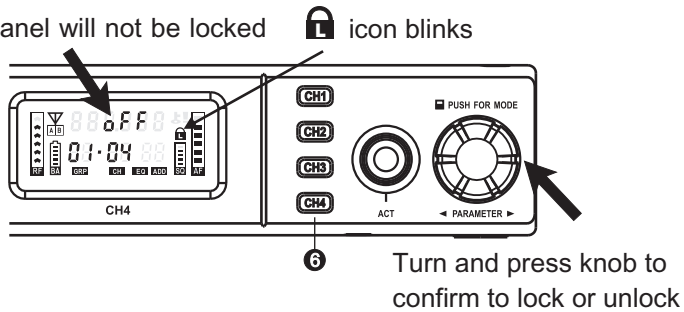







Fig. 20

- (1) Press channel selection button **6** to set up the panel lock status for each channel.
- (2) Panel Lock Set-up: Press rotary knob to  cursor.  cursor blinks to denote it is ready to accept parameter changes. Press and hold knob for 2~3 seconds until " $\square n$ " & " $\square FF$ " appears interchangeably. " $\square n$ " blinks together with  cursor. Press knob to confirm lock panel while " $\square n$ " blinks. " $\square FF$ " blinks without  cursor. Press knob to confirm unlock panel while " $\square FF$ " blinks.
- (3) Receiver parameters can no longer be changed when it is in locked status with  icon. To change parameters you need to unlock the receiver panel first.

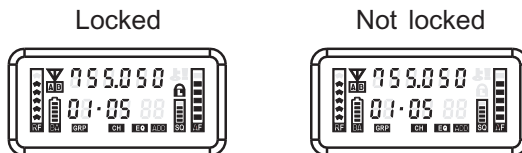
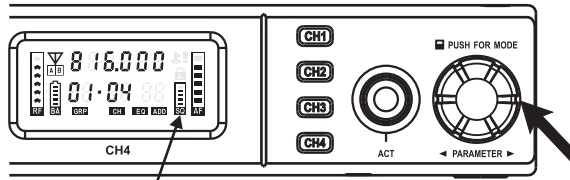

Fig. 21

(H) SQUELCH Setting, Fig. 22:



SQ Cursor

Turn knob right to increase an indicator
Turn knob left to decrease an indicator

Fig. 22

- (1) Press rotary knob to select SQ meter. SQ cursor blinks to denote it is ready to accept parameter changes.
- (2) Turn the knob right to increase indicator grids. Turn left to decrease indicator grids.
- (3) After changing the parameter, press the knob again, SQ cursor stops blinking and saves the new value automatically.
- (4) The lower the SQ level, the higher sensitivity level is when searching automatically for a non-interference channel. When SQ is set as the highest level, the frequency can be selected forcibly regardless the level of external interferences.
- (5) The SQ setting, regardless high or low, will not affect the receiver's sensitivity during a performance.

(I) ACT Sync Set-up, Fig. 23:

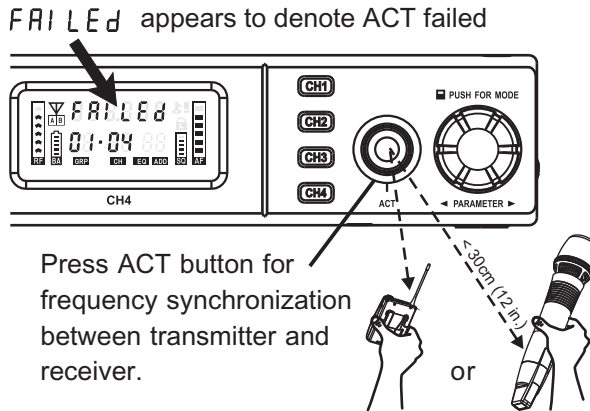



Fig. 23

- (1) Press ACT button, "54nC" appears on the VFD screen and ACT Sync can be operated. If the transmitter was not synchronized within 10 seconds, the word "FAILED" appears on the VFD screen.
- (2) Ensure transmitter is powered-on. Align the ACT IR port of both transmitter and receiver within 30 cm.
- (3) Once sync is completed and successfully, the ACT function will stop automatically and GRP parameters & full grid of RF meter ⑳ are displayed on the VFD screen. The LCD on the transmitter also displayed the same group and channel of receiver simultaneously.

5. Unchangeable Setting Display:

(A) BA  displays the battery meter in percentage (%) indication of remaining battery life when received the transmitter signal. Replace with new, fresh batteries when battery indicators fall to 10% (1 indicator remaining), as shown in Fig. 24.

** To know the percentage indication of battery life. Please refer to the user guide of each transmitter.



Fig. 24

(B) Error Message: "ERR01" indicates internal data error.

VI. Computer Network-interfaced Operation

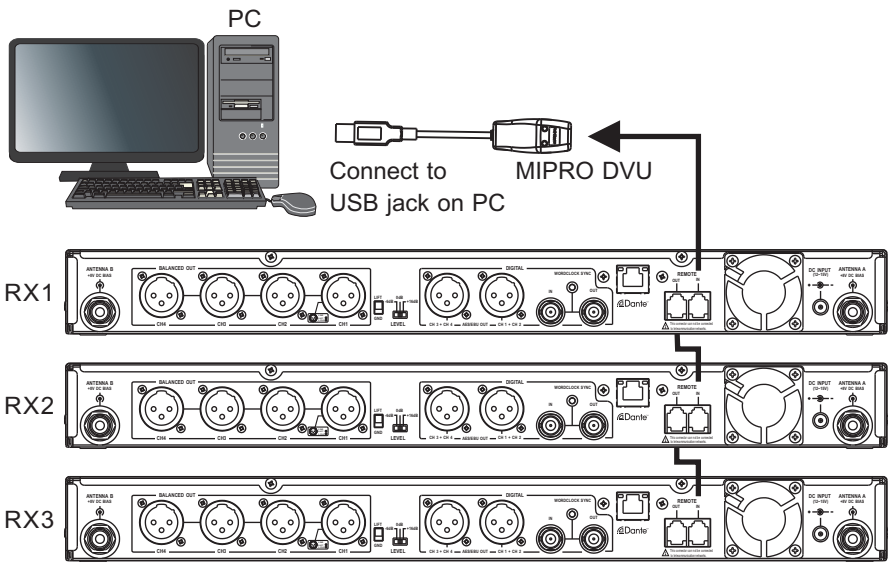

Fig.25

1. This receiver has advanced computer network-interfaced with MIPRO DV.
2. MIPRO DV Wiring Instructions, Fig. 25:
 - (A) Use supplied hardware cable for serial connection to MIPRO receivers and PC network interface connector 17.
 - (B) Next, use an USB connector to link receivers input interface connector via MIPRO DVU to a computer USB PORT.
 - (C) Up to 64 receiver channels can be connected, remote-controlled and monitored.
 - (D) The network cable length can be connected up to 300 meters, but the longer it is, the transmission quality will be more unstable. The ideal cable length for optimal transmission quality is less than 100 meters.

VII. Dante Network Operation (For Optional Dante interface)

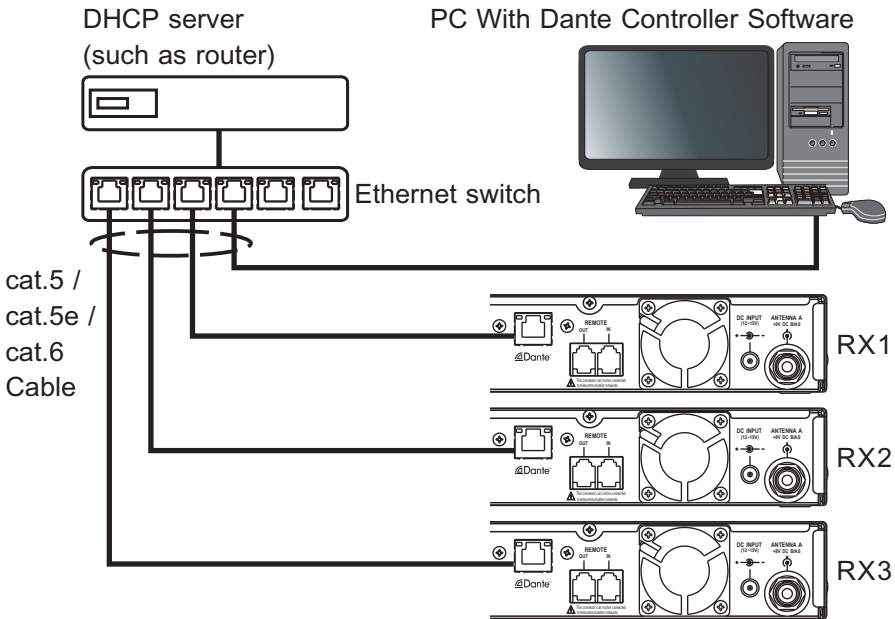

Fig. 26

1. Dante Network, Fig. 26:

Connect MIPRO ACT-828 / ACT-848 via Dante port by Cat.5, Cat.5e, or Cat.6 cable with Ethernet switch to construct Dante network.

2. Note: The Ethernet switch needs to be connected with a DHCP server such as router to provide DHCP function.
3. Software Operating Instructions: Install Dante Controller software in PC to perform audio stream routing and monitoring.
4. The user guide of Dante Controller can be downloaded at the website of Audinate:

<https://www.audinate.com/products/software/dante-controller>

MIPRO[®]
MICROPHONE PROFESSIONALS

MIPRO Electronics Co., Ltd

Headquarters: 814 Pei-Kang Road, Chiayi, 60096, Taiwan
Tel : +886.5.238.0809
www.mipro.com.tw

Fax : +886.5.238.0803
mipro@mipro.com.tw



All rights reserved. MN 019/06

Do not copy or forward without prior approvals MIPRO.

Specifications and design subject to change without notice.



2 CE629A