

Masif.[™]
settelenti.

RGBW



IP65

SUITABLE FOR OUTDOOR USE

 **blizzard**

Blizzard Lighting, LLC
<http://www.blizzardpro.com>
Waukesha, WI USA
Copyright (c) 2023

TABLE OF CONTENTS

1. Getting Started	3
What's In The Box?	3
Getting It Out Of The Box	3
Powering Up!	3
Getting A Hold Of Us	3
Safety Instructions	4
2. Meet the Motif™ Settelenti	5
Main Features	5
DMX Quick Reference	5
Motif™ Settelenti Pin-Up Picture	6
Rear Connections	6
3. Setup	7
Fuse Replacement	7
Connecting A Bunch of Motif™ Settelenti Fixtures	7
Data/DMX Cabling	7
Cable Connectors	8
3-Pin??? 5-Pin??? Huh?!?	8
Take It To The Next Level: Setting Up DMX Control	8
Fixture Linking (M/S Mode)	9
Mounting & Rigging	9
4. Operating Adjustments	10
The Control Panel	10
Control Panel Menu Structure	11
Starting DMX Address	11
DMX Channel Mode	11
Run Mode	11
DMX Values In-Depth	12-13
5. Appendix	14
Keeping Your Motif™ Settelenti As Good As New	14
Returns (Gasp!)	14
Shipping Issues	14
Dimensional Drawings	15

1. GETTING STARTED

What's In The Box?

- Motif™ Settelenti RGBW LED Fixture
- Power Cord
- This Lovely User Manual

Getting It Out Of The Box

Congratulations on purchasing the Motif™ Settelenti. Now that you've got your fixture, you should carefully unpack the box and check the contents to ensure that all parts are present and in good condition. If anything looks as if it has been damaged in transit, notify the shipper immediately and keep the packing material for inspection. Again, please save the carton and all packing materials. If a fixture must be returned to the factory, it is important that the fixture be returned in the original factory box and packing.

Powering Up!

All fixtures must be powered directly off a switched circuit and **cannot be run off a rheostat (variable resistor) or dimmer circuit, even if the rheostat or dimmer channel is used solely for a 0% to 100% switch.**

AC Voltage Switch - Not all fixtures have a voltage select switch, so please verify that the fixture you receive is suitable for your local power supply. See the label on the fixture or refer to the fixture's specifications chart for more information. A fixture's listed current rating is its average current draw under normal conditions. Check the fixture or device carefully to make sure that if a voltage selection switch exists that it is set to the correct line voltage you will use.

Warning! Verify that the voltage select switch on your unit matches the line voltage applied. Damage to your fixture may result if the line voltage applied does not match the voltage indicated on the voltage selector switch. All fixtures must be connected to circuits with a suitable Ground (Earthing).

Getting A Hold Of Us

If something is wrong, please just visit our website at www.blizzardpro.com/ support and open a support ticket. We'll be happy to help, honest.

Disclaimer: The information contained in this document are subject to change without notice. Blizzard Lighting™ assumes no responsibility or liability for any errors or omissions that may appear in this user manual. We reserve the right to update the existing, or create a new document to correct any errors or omissions. You can download the latest version of this document from www.blizzardpro.com.

Author:	Date:	Last Edited:	Date:
J. Thomas	4/20/2022	J. Thomas	7/27/2023

Safety Instructions



Please read these instructions carefully. They include important information about the installation, usage and maintenance of this product.

- Please keep this User Guide for future use. If you sell the unit to someone else, be sure that they also receive this User Guide.
- ALWAYS make sure that you are connecting to the proper voltage, and that the line voltage you are connecting to is not higher than that stated on the decal or rear panel of the fixture.
- Make sure there are no flammable materials close to the unit while operating.
- The unit must be installed in a location with adequate ventilation, at least 20in (50cm) from adjacent surfaces. Be sure that no ventilation slots are blocked.
- ALWAYS disconnect from the power source before servicing or replacing fuse and be sure to replace with same fuse size and type.
- ALWAYS secure fixture using a safety chain. NEVER carry the fixture by its head. Use its carrying handles.
- DO NOT operate at ambient temperatures higher than 104°F (40°C).
- In the event of a serious operating problem, stop using the unit immediately. NEVER try to repair the unit by yourself. Repairs carried out by unskilled people can lead to damage or malfunction. Please contact the nearest authorized technical assistance center. Always use the same type spare parts.
- NEVER connect the device to a dimmer pack.
- Make sure the power cord is never crimped or damaged.
- Never disconnect the power cord by pulling or tugging on the cord.
- Avoid direct eye exposure to the light source while it is on.

Caution! There are no user serviceable parts inside the unit. Do not open the housing or attempt any repairs yourself. In the unlikely event your unit may require service, please open a support ticket at www.blizzardpro.com/support.

2. MEET THE MOTIF™ SETTELENTI

Main Features

- 7x 40W flicker-free 4-in-1 RGBW LEDs (60,000 hours)
- 96x 0.2W RGB SMD LEDs
- IP65 rated, suitable for outdoor use
- Smooth 0-100% linear dimming
- 5.7° to 38° zoomable beam angle
- Individually controllable LED/SMD color presets + auto
- 1-20Hz strobe effects
- IP65 rated 3-pin DMX and power in/out connections
- powerCON™ TRUE1 compatible power in/out
- Heavy-duty aluminum enclosure

Control

- Protocol: USITT DMX-512, RDM
- DMX Channels: 9/19-channels
- 4-button colored LCD menu w/touch sensitive buttons
- Operating modes: DMX512, M/S, auto

DMX Quick Reference (9/19-Channel Modes)

9CH	19CH	What it does
--	1	Dimmer (40W LEDs, 0% - 100%)
1	2	Red intensity (40W LEDs, 0% - 100%)
2	3	Green intensity (40W LEDs, 0% - 100%)
3	4	Blue intensity (40W LEDs, 0% - 100%)
4	5	White intensity (40W LEDs, 0% - 100%)
--	6	Strobe (40W LEDs, slow to fast)
5	7	Zoom (0% - 100%)
--	8	Color macros + white presets (40W LEDs)
--	9	Auto programs (40W LEDs)
--	10	Auto speed (40W LEDs, slow to fast)
--	11	Dimmer (SMD LEDs, 0% - 100%)
6	12	Red (SMD LEDs, 0% - 100%)
7	13	Green (SMD LEDs, 0% - 100%)
8	14	Blue (SMD LEDs, 0% - 100%)
--	15	Strobe (SMD LEDs, slow to fast)
--	16	Color Macros (SMD LEDs)
--	17	Auto Programs (SMD LEDs)
--	18	Auto Speed (SMD LEDs, slow to fast)
9	19	Reset (keep the value for 3 seconds)

Figure 1: Motif™ Settelenti Pin-Up Picture



Figure 2: Rear Connections

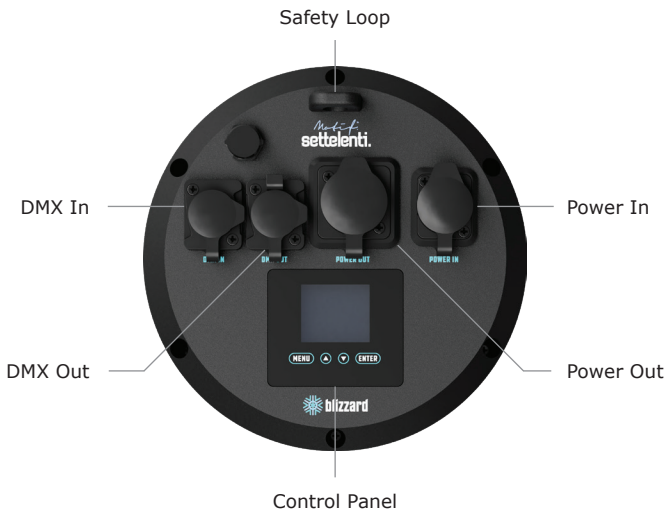

3. SETUP



Before replacing a fuse, disconnect the power cord.
ALWAYS replace with the same type and rating of fuse.

Fuse Replacement

This fixture utilizes a high-output switch-mode power supply with an internal fuse. Under normal conditions, the fuse should not require replacement. Should your fixture require fuse replacement, please contact us for instructions.

Connecting A Bunch of Motif™ Settelenti Fixtures

You will need a serial data link to run light shows using a DMX-512 controller or to run shows on two or more fixtures set to sync in master/slave operating mode. The combined number of channels required by all the fixtures on a serial data link determines the number of fixtures the data link can support.

Fixtures on a serial data link must be daisy chained in a single line. Also, connecting more than 32 fixtures on one serial data link without the use of an optically-isolated DMX splitter may result in deterioration of DMX signal. The maximum recommended cable-run distance is 500 meters (1640 ft).

Data/DMX Cabling

To link fixtures together you'll need data cables. You should use data-grade cables that can carry a high quality signal and are less prone to electromagnetic interference.

For instance, Belden© 9841 meets the specifications for EIA RS-485 applications. Standard microphone cables will "probably" be OK, but note that they cannot transmit DMX data as reliably over long distances. In any event, the cable should have the following characteristics:

- *2-conductor twisted pair plus a shield*
- *Maximum capacitance between conductors – 30 pF/ft.*
- *Maximum capacitance between conductor & shield – 55 pF/ft.*
- *Maximum resistance of 20 ohms / 1000 ft.*
- *Nominal impedance 100 – 140 ohms*

Disclaimer: The power connectors fitted to the fixture and fixture cord are designed for compatibility with products manufactured by Neutrik AG, Neutrik USA and their related entities, however they are not manufactured by, affiliated with or endorsed by Neutrik AG, Neutrik USA, or any related entity. Neutrik® and powerCON® are registered trademarks of Neutrik AG.

Cable Connectors

Cables must have a male XLR connector on one end and a female XLR connector on the other end. (Duh!)

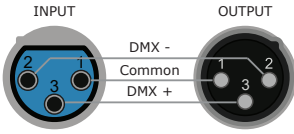

A Word on Termination:

DMX is a resilient communication protocol, however errors still occasionally occur. Termination reduces signal errors, and therefore best practices include use of a terminator in all circumstances. If you are experiencing problems with erratic fixture behavior, especially over long signal cable runs, a terminator may help improve performance.

To build your own DMX Terminator:

Obtain a 120-ohm, 1/4-watt resistor, and wire it between pins 2 & 3 of the last fixture. They are also readily available from specialty retailers.

CAUTION: Do not allow contact between the common and the fixture's chassis ground. Grounding the common can cause a ground loop, and your fixture may perform erratically. Test cables with an ohm meter to verify correct polarity and to make sure the pins are not grounded or shorted to the shield or each other.

3-Pin??? 5-Pin??? Huh?!?

If you use a controller with a 5 pin DMX output connector, you will need to use a 5 pin to 3 pin adapter. They are widely available over the internet and from specialty retailers. If you'd like to build your own, the chart below details a proper cable conversion:

Conductor	3-Pin Female (Output)	5-Pin Male (Input)
Ground/Shield	Pin 1	Pin 1
Data 1- (Primary Data Link)	Pin 2	Pin 2
Data 1+ (Primary Data Link)	Pin 3	Pin 3
Data 2- (Optional Secondary Data Link)	--	Pin 4 - Do Not Use
Data 2+ (Optional Secondary Data Link)	--	Pin 5 - Do Not Use

Take It To The Next Level: Setting Up DMX Control

Step 1: Connect the male connector of the DMX cable to the female connector (output) on the controller.

Step 2: Connect the female connector of the DMX cable to the first fixture's male connector (input).

Note: It doesn't matter which fixture address is the first one connected. We recommend connecting the fixtures in terms of their proximity to the controller, rather than connecting the lowest fixture number first, and so on.

Step 3: Connect other fixtures in the chain from output to input as above. Place a DMX terminator on the output of the final fixture to ensure best communication.

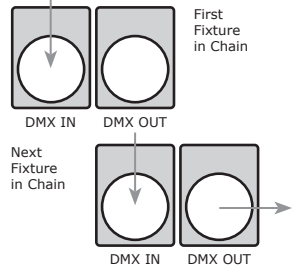

Fixture Linking (M/S Mode)

1. Connect the male connector side of the DMX cable to the output female connector of the first fixture.

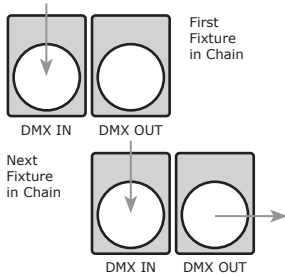

2. Connect the end of the cable coming from the first fixture which will have a female connector to the input connector of the next fixture consisting of a male connector. Then, proceed to connect from the output as stated above to the input of the following fixture and so on.

A quick note: Often, the setup for Master-Slave and Standalone operation requires that the first fixture in the chain be initialized for this purpose via either settings in the control panel or DIP-switches. Secondly, the fixtures that follow may also require a slave setting.

Check the **"Operating Adjustments"** section in this manual for complete instructions for this type of setup and configuration.

Mounting & Rigging

This fixture may be mounted in any SAFE position provided there is enough room for ventilation. The fan or vent pathway must never be obstructed.

IMPORTANT: Regardless of the rigging option you choose for your fixtures, always be sure to secure your fixture with a safety cable.

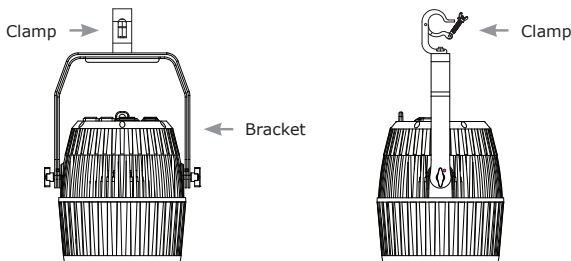

Mount the fixture using a suitable "C" or "O" type clamp. The clamp should be rated to hold at least 10x the fixture's weight to ensure structural stability. Do not mount to surfaces of unknown strength, and ensure properly rated rigging is used when mounting fixtures overhead.

Overhead mounting requires extensive experience, which includes calculating working load limits, knowledge of the installation material being used, and periodic safety inspections. If you lack these qualifications, do not attempt the installation yourself.

4. OPERATING ADJUSTMENTS

The Control Panel

All the features and different modes possible with the Motif™ Settelenti are accessed by using the control panel on the rear of the fixture. There are 4 control buttons under to the LCD display which allow you to navigate through the various control panel menus.

<MENU>

Is used to navigate to the previous higher-level menu item.

<UP>

Scrolls through menu items and numbers in ascending order.

<DOWN>

Scrolls through menu items and numbers in descending order.

<ENTER>

Is used to select and confirm/store the current selection.

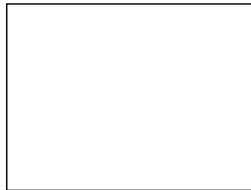

The control panel LCD display shows the menu items you select from the menu map on page #11. When a menu function is selected, the display will show immediately the first available option for the selected menu function. To select a menu item, press **<ENTER>**.

Use the **<UP>** and **<DOWN>** buttons to navigate the menu options. Press the **<ENTER>** button to select the menu function currently displayed, or to enable a menu option. To return to the previous option or menu without changing the value, press the **<MENU>** button.

Control Panel Menu Structure

Address	001-512	Set the starting address from 001-512	
Run Mode	DMX512	Set the fixture to run in DMX mode	
	Auto 1 (40W LEDs)	Program 1	
		Program 2	
		Program 3	
		Program 4	
		Program 5	
		Program 6	
		Program 7	
		Program 8	
		Auto run (40W LED programs 1-8)	
		Auto speed	
		Zoom	Manual (0-255, wide <-> narrow)
			Auto Zoom (Off/On)
	Auto 2 (SMD LEDs)	Program 1	
		Program 2	
		Program 3	
		Program 4	
		Program 5	
		Program 6	
		Program 7	
Program 8			
Auto run (SMD LED programs 1-8)			
Auto speed			
Zoom		Manual (0-255, wide <-> narrow)	
		Auto Zoom (Off/On)	
CH Mode	9CH	9-channel DMX mode	
	19CH	19-channel DMX mode	
Manual	Red	Red intensity (0-100%)	
	Green	Green intensity (0-100%)	
	Blue	Blue intensity (0-100%)	
	White	White intensity (0-100%)	
	SMD R	Red SMD LED intensity (0-100%)	
	SMD G	Green SMD LED intensity (0-100%)	
	SMD B	Blue SMD LED intensity (0-100%)	
	Presets	White Presets 1-11 (0-100%)	
	Strobe	Strobe (0-20, slow <-> fast)	
	Zoom	Zoom (narrow <-> wide)	
Set	Display	Yes/No (to flip the display)	
	Slave	Yes/No (Yes = Master, No = Slave Units)	
	Keylock	Yes/No	
		*If set to Yes, press UP, DOWN, UP, DOWN, ENTER when returning to the menu after a screen timeout occurs. The menu goes dark after 1 minute of inactivity.	
	DMX Fail	Hold (holds last signal if DMX is lost) Blackout (blackout if DMX signal is lost)	
Info	Version	Displays the firmware version	
Reset	Yes/No	Reset the fixture	

DMX Values In-Depth (9/19-Channel Modes)

9CH	19CH	Value	What it does
--	1	000 <-> 255	Dimmer (40W LEDs, 0% - 100%)
1	2	000 <-> 255	Red (40W LEDs, 0% - 100%)
2	3	000 <-> 255	Green (40W LEDs, 0% - 100%)
3	4	000 <-> 255	Blue (40W LEDs, 0% - 100%)
4	5	000 <-> 255	White (40W LEDs, 0% - 100%)
--	6	000 <-> 255	Strobe (40W LEDs, slow to fast)
5	7	000 <-> 255	Zoom (wide to narrow)
--	8	000 <-> 009 10 011 <-> 029 30 031 <-> 049 50 051 <-> 069 70 071 <-> 089 90 091 <-> 109 110 111 <-> 129 130 131 <-> 141 142 <-> 152 153 <-> 163 164 <-> 174 175 <-> 185 186 <-> 196 197 <-> 207 208 <-> 218 219 <-> 229 230 <-> 240 241 <-> 255	Manual Color & White Presets (40W LEDs) No function Red R: 100%, G: Up, B: 0% Yellow R: Down, G: 100%, B: 0% Green R: 0%, G: 100%, B: Up Cyan R: 0%, G: Down, B: 100% Blue R: Up, G: 0%, B: 100% Magenta R: 100%, G: Up, B: 100%, W: Up RGBW 100% White 1 (3800K) White 2 (4000K) White 3 (4400K) White 4 (4700K) White 5 (5000K) White 6 (5100K) White 7 (5300K) White 8 (5400K) White 9 (5600K) White 10 (6300K) White 11 (7800K)
--	9	000 <-> 009 010 <-> 037 038 <-> 065 066 <-> 093 094 <-> 121 122 <-> 149 150 <-> 177 178 <-> 205 206 <-> 233 234 <-> 255	Auto Programs (40W LEDs) No Function Program 1 Program 2 Program 3 Program 4 Program 5 Program 6 Program 7 Program 8 Auto run (1-8)
--	10	000 <-> 255	Auto speed (40W LEDs, slow to fast)

DMX Values In-Depth (9/19-Channel Modes)

9CH	19CH	Value	What it does
--	11	000 <-> 255	Dimmer (SMD LEDs, 0% - 100%)
6	12	000 <-> 255	Red (SMD LEDs, 0% - 100%)
7	13	000 <-> 255	Green (SMD LEDs, 0% - 100%)
8	14	000 <-> 255	Blue (SMD LEDs, 0% - 100%)
--	15	000 <-> 255	Strobe (SMD LEDs, slow to fast)
--	16	000 <-> 009 10 011 <-> 049 50 051 <-> 089 90 091 <-> 129 130 131 <-> 169 170 171 <-> 209 210 211 <-> 254 255	Manual Color (SMD LEDs) No function Red R: 100%, G: Up, B: 0% Yellow R: Down, G: 100%, B: 0% Green R: 0%, G: 100%, B: Up Cyan R: 0%, G: Down, B: 100% Blue R: Up, G: 0%, B: 100% Magenta R: 100%, G: Up, B: 100% RGB 100%
--	17	000 <-> 009 010 <-> 037 038 <-> 065 066 <-> 093 094 <-> 121 122 <-> 149 150 <-> 177 178 <-> 205 206 <-> 233 234 <-> 255	Auto Programs (SMD LEDs) No Function Program 1 Program 2 Program 3 Program 4 Program 5 Program 6 Program 7 Program 8 Auto run (1-8)
--	18	000 <-> 255	Auto Speed (SMD LEDs, slow to fast)
9	19	000 <-> 255	Reset (keep the value for 3 seconds)

5. APPENDIX

Keeping Your Motif™ Settelenti As Good As New

The fixture you've received is a rugged, tough piece of pro lighting equipment, and as long as you take care of it, it will take care of you. That said, you'll need to take care of it if you want it to operate as designed. You should keep the fixture clean, especially if you are using it in an environment with a lot of dust, fog, haze, wild animals, wild teenagers or spilled drinks.

Cleaning the optics routinely with a suitable glass cleaner will greatly improve the quality of light output. Keeping the fans free of dust and debris will keep the fixture running cool and prevent damage from overheating.

In transit, keep the fixtures in cases. You wouldn't throw a prized guitar, drumset, or other piece of expensive gear into a gear trailer without a case, and similarly, you shouldn't even think about doing it with your shiny new light fixtures.

Common sense and taking care of your fixtures will be the single biggest thing you can do to keep them running at peak performance and let you worry about designing a great light show, putting on a great concert, or maximizing your client's satisfaction and "wow factor." That's what it's all about, after all!

Returns (Gasp!)

We've taken a lot of precautions to make sure you never even have to worry about sending a defective unit back, or sending a unit in for service. But, like any complex piece of equipment designed and built by humans, once in a while, something doesn't go as planned. If you find yourself with a fixture that isn't behaving like a good little fixture should, you'll need to obtain a Return Authorization (RA).

Don't worry, this is easy. Just visit www.blizzardpro.com/support and open a support ticket, and we'll issue you an RA. Then, you'll need to send the unit to us using a trackable, pre-paid freight method. We suggest using USPS Priority or UPS. Make sure you carefully pack the fixture for transit, and whenever possible, use the original box & packing for shipping.

When returning your fixture for service, be sure to include the following:

- 1.) Your contact information (Name, Address, Phone Number, Email address).
- 2.) The RA# issued to you
- 3.) A brief description of the problem/symptoms.

We will, at our discretion, repair or replace the fixture. Please remember that any shipping damage which occurs in transit to us is the customer's responsibility, so pack it well!

Shipping Issues

Damage incurred in shipping is the responsibility of the shipper, and must be reported to the carrier immediately upon receipt of the items. Claims must be made within seven (7) days of receipt.

Tech Specs!

Weight & Dimensions	
Width	11.5 inches (291 mm)
Depth	9.4 inches (238 mm)
Height	10.5 inches (266 mm)
Weight	20 lbs (9.1 kg)
Power	
Operating Voltage	AC 90V-260V/50-60Hz
Power Consumption	232W, 1.99A, PF: .99
Light Source	
LED	7x 40W 4-in-1 RGBW LEDs (60,000 hours) 96x 0.2W RGB SMD LEDs
Luminous Intensity	11,688 Lux @ 2.5M (narrow) 1,083 Lux @ 2.5M (wide) 2,644 Lux @ 5M (narrow) 248 Lux @ 5M (wide)
Optical	
Beam Angle	5.7° to 38° zoomable beam angle
Thermal	
Max. Operating Temp.	104 degrees F (40 degrees C) ambient
Control	
Protocol	USITT DMX-512, RDM
DMX Channels	9/17-channel DMX modes
Input/Output	3-pin XLR Male/Female
Other Operating Modes	DMX512, M/S, Standalone, Auto Mode
Warranty	2-year limited warranty, does not cover malfunction caused by damage to LEDs.

Dimensional Drawings

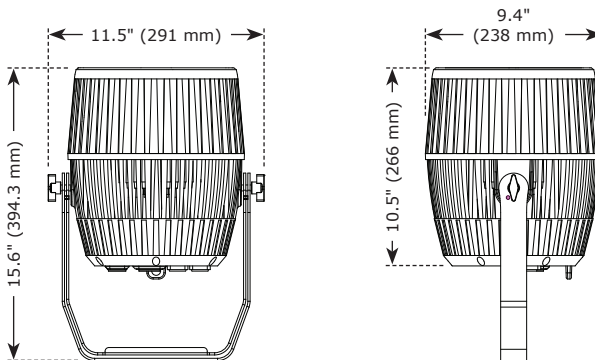



**Enjoy your product!
Our sincerest thanks for your purchase!
--The team @ Blizzard Lighting**