

MIPRO[®]

User Guide

**MM-202 / MM-202B / MM-202C /
MM-202S / MM-202P / MM-202J
Gooseneck Microphone**

**MM-202A
Ultra Miniature Gooseneck Microphone**



MIPRO[®]
MICROPHONE PROFESSIONALS

MIPRO Electronics Co., Ltd

Headquarters : 814 Pei-Kang Road, Chiayi, 60096, Taiwan
Tel : +886.5.238.0809 Fax : +886.5.238.0803
www.mipro.com.tw mipro@mipro.com.tw



2CE304C

All rights reserved. MN 014/06

Do not copy or forward without prior approvals MIPRO.

Specifications and design subject to change without notice.

Key Features

- Ultra slim profile design for podiums, pulpit and lectern applications.
- Proprietary microphone mount design allows 110° up/down and 300° left/right angle adjustments. (MM-202/MM-202B/MM-202C/MM-202A)
- Shock isolation mount design minimizes surface vibration noise.
- Multi-layered microphone grills ensures breath "POP" noise is minimized.
- Wide dynamic range and frequency response for accurate sound reproduction across the audio spectrum.
- Can be connected to MJ-53 Condenser Microphone Adaptor and runs on 48-volt phantom power and used as a gooseneck desktop microphone. (MM-202/MM-202B/MM-202C/MM-202A/MM-202S)
- 3.5mm ϕ mini jack plug for MIPRO digital wireless tour guide system transmitters. (MM-202P)
- MM-202J requires external 48-volt phantom power and used as a desktop gooseneck microphone.

Specifications

Gooseneck Diameter	10mm ϕ uni-directional condenser microphone
Plug	MM-202/MM-202B/MM-202C/MM-202A/MM-202S: TA4F 4-pin Connector MM-202P: 3.5mm mini jack MM-202J: Cannon Plug
CoLor	Black
Gooseneck Length	MM-202: 470mm / 18.5" MM-202B: 370mm / 14.5" MM-202C: 600mm / 23.6" MM-202A: 130mm / 5.1" MM-202S: 130mm / 5.1" MM-202P: 136mm / 5.3" MM-202J: 535mm (21.06") / 435mm (17.13")
Note	Refer to actual product in the event of product discrepancy

Part Names and Functions

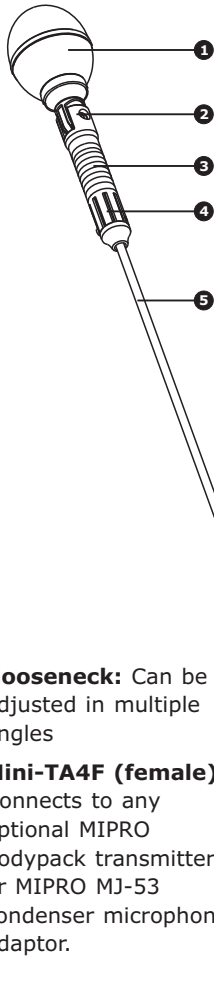
**MM-202/MM-202B/
MM-202C****1 Microphone Module:**

Microphone capsule protected by multi-layered grills and effectively prevents 'pop' noise.

2 Rotation Hub: Can bend approx 110 degrees.

3 Shock-mount Suspension: Reduces touch noise

4 Rotation Hub: Can rotate approx. 300 degrees.

5 Steel Boom.

6 Gooseneck: Can be adjusted in multiple angles

7 Mini-TA4F (female): Connects to any optional MIPRO bodypack transmitter or MIPRO MJ-53 condenser microphone adaptor.

Part Names and Functions

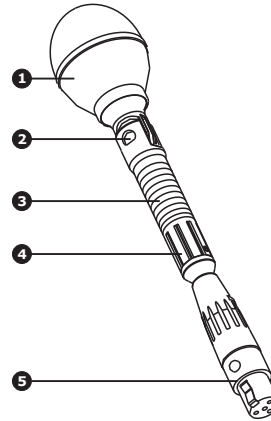
MM-202A

1 Microphone Module: Microphone capsule protected by multi-layered grills and effectively prevents 'pop' noise.

2 Rotation Hub: Can bend approx 110 degrees.

3 Shock-mount Suspension: Reduces touch noise.

4 Rotation Hub: Can rotate approx. 300 degrees.

5 Mini-4-pin TA4F (female): Connects to any MIPRO bodypack transmitter for wireless audio transmission or MIPRO MJ-53 condenser microphone adaptor for wired (installed) audio transmission.

Part Names and Functions

**MM-202J**

- 1 Microphone Module:** Microphone capsule protected by multi-layered grills and effectively prevents 'pop' noise.
- 2 Rotation Hub:** Can bend approx 110 degrees.
- 3 Shock-mount Suspension:** Reduces touch noise
- 4 Rotation Hub:** Can rotate approx. 300 degrees.
- 5 Steel Boom.**

- 6 Gooseneck:** Can be adjusted in multiple angles.
- 7 Cannon Plug:** Requires external 48-volt phantom power and used as a desktop gooseneck microphone.

Part Names and Functions

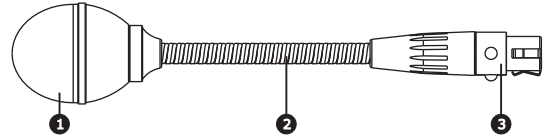
MM-202S

- 1 Microphone Module:** Microphone capsule protected by multi-layered grills and effectively prevents 'pop' noise.
- 2 Gooseneck:** Can be adjusted in multiple angles.
- 3 Mini-TA4F (female):** Connects to any optional MIPRO bodypack transmitter or MIPRO MJ-53 condenser microphone adaptor.

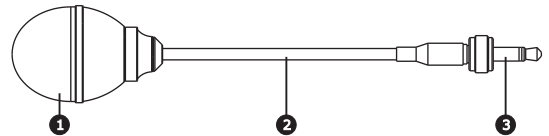
MM-202P

- 1 Microphone Module:** Microphone capsule protected by multi-layered grills and effectively prevents 'pop' noise.
- 2 Gooseneck:** Can be adjusted in multiple angles.
- 3 PHONE JACK PLUG :** 3.5mm ϕ mini jack plug for MIPRO digital wireless tour guide system transmitters.

MM-202/MM-202B/MM-202C/MM-202A Desktop Install Instructions

Wireless Audio Transmission:

- Plug MM-202/MM-202B/MM-202C/MM-202A into an optional MIPRO bodypack transmitter and MD-101 desktop base holder. (see diagram 1)

Wired Audio Transmission:

- Plug MM-202/MM-202B/MM-202C/MM-202A into an optional MIPRO MJ-53 condenser microphone adaptor and MJ-53 into any 48-volt phantom powered desktop base with balanced XLR female. (See diagram 2)

Applications:

- Ideal for applications in lecterns, podiums, desks, and tabletops.

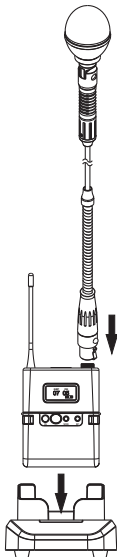

(Figure 1)

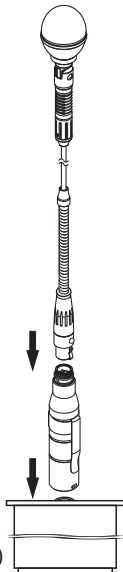

(Figure 2)

Operating Instructions for external Gooseneck Microphone

1. Switch to MM-202 input position.

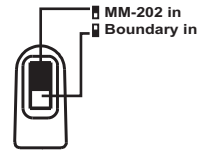

2. Remove protective cover. Ensure the Talk/Mute button is at Mute position (up) before gooseneck microphone is inserted into the connector as shown to avoid the undesired noises.

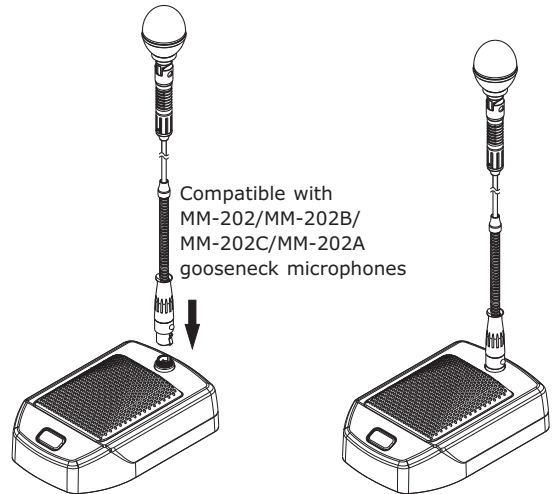

BC-100 Wireless Boundary Microphone

Install Instructions

MM-202A/MA-202S Wireless Audio Transmission:

- Plug MM-202A/MM-202S into an optional MIPRO bodypack transmitter and it can be used as a 'handheld' microphone for mobile application. (see diagram 3)

Applications:

- Ideal for wireless 'handheld' or installed lecterns, podiums, desks, and tabletops applications.

MM-202P Wireless Audio Transmission:

- Mini-Gooseneck Microphone. (once plugged, it can be used as a handheld)
- Insert & fasten the optional MM-202P microphone. (see diagram 4)

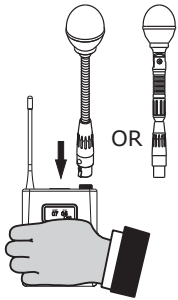

(Figure 3)

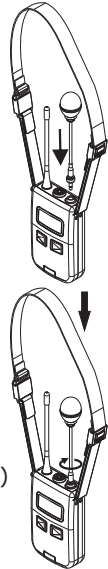

(Figure 4)

MM-202J Install Instructions

- Two different lengths for different amplification applications.
- Requires external 48-volt phantom power and used as a desktop gooseneck microphone.

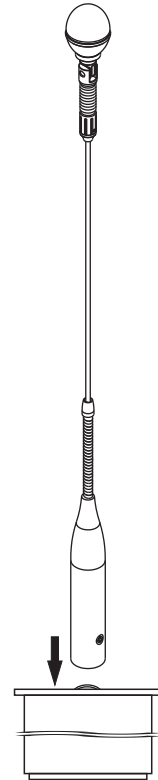

(Figure 5)

Frequency Response

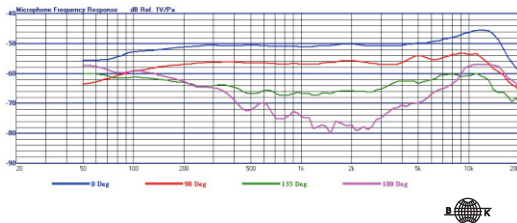

Polar Pattern

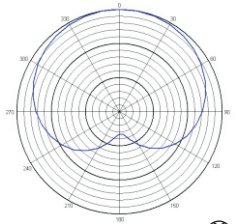

Disposal Dispose of any unusable devices or batteries responsibly and in accordance with any applicable regulations.



2005-06-10

Disposing of used batteries with domestic waste is to be avoided!

Batteries / NiCad cells often contain heavy metals such as cadmium(Cd), mercury(Hg) and lead(Pb) that makes them unsuitable for disposal with domestic waste. You may return spent batteries/ accumulators free of charge to recycling centres or anywhere else batteries/accumulators are sold.

By doing so, you contribute to the conservation of our environment!

FCC

THIS DEVICE COMPLIES WITH PART 74 OF THE FCC RULES.

OPERATION IS SUBJECT TO THE FOLLOWING TWO CONDITIONS:

- (1) This device may not cause interference.
- (2) This device must accept any interference, including interference that may cause undesired operation of the device.

This equipment complies with FCC RF radiation exposure limits set forth for an uncontrolled environment.

IC

This device complies with Industry Canada RSS-123 ISSUE 2 standards. Operation is subject to the following two conditions:

- (1) this device may not cause interference, and
- (2) this device must accept any interference, including interference that may cause undesired operation of the device.

Le présent appareil est conforme aux CNR d'Industrie Canada applicables aux appareils radio exempts de licence. L'exploitation est autorisée aux deux conditions suivantes:

- (1) l'appareil ne doit pas produire de brouillage, et
- (2) l'utilisateur de l'appareil doit accepter tout brouillage radioélectrique subi, même si le brouillage est susceptible d'en compromettre le fonctionnement.

Notes

1. Refer to actual product in the event of product description discrepancy.