

CM-BGM-II Series

Install Instructions for:

CM52-BGM-II, CM52s-BGM-II, CM62-BGM-II, and CM82-BGM-II

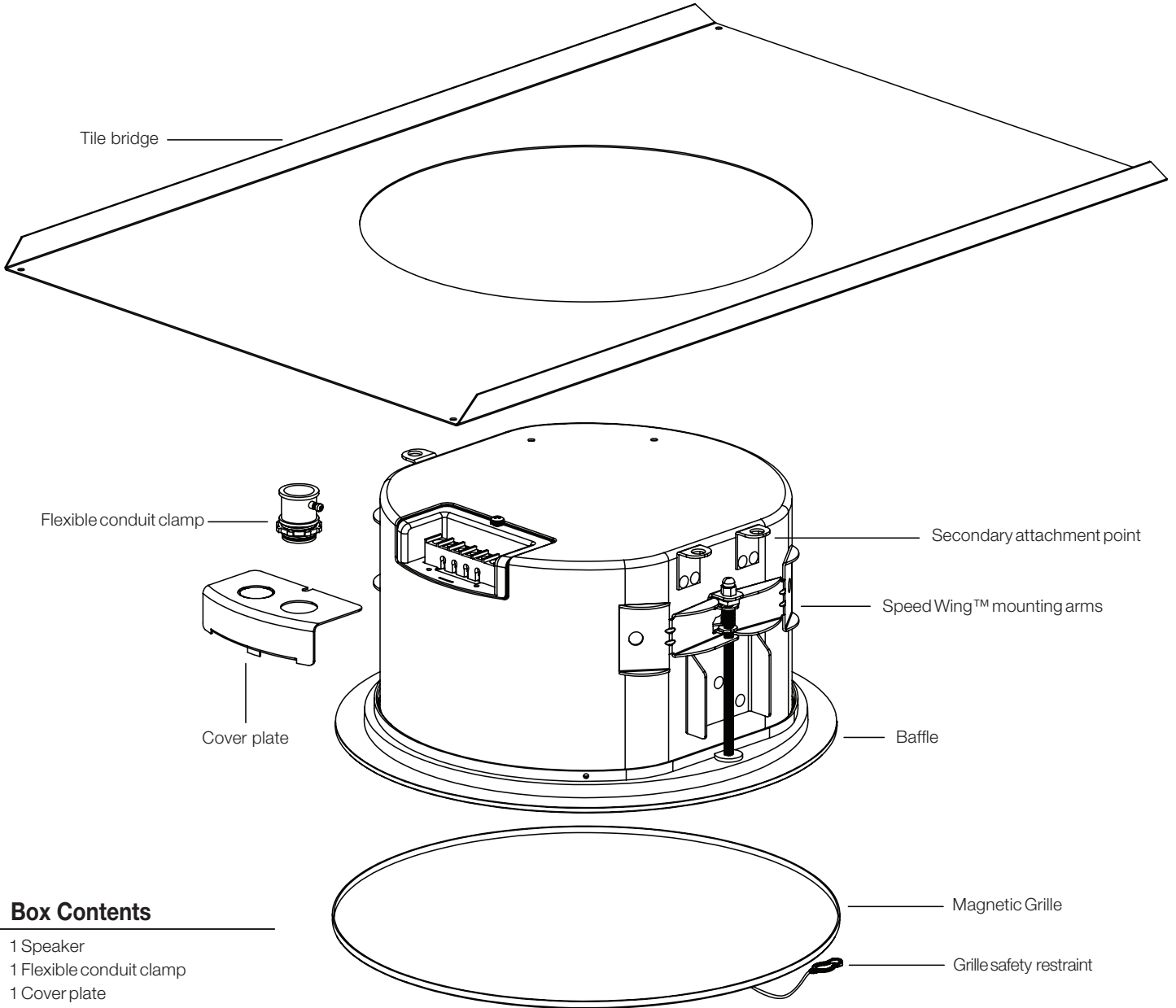

Box Contents

- 1 Speaker
- 1 Flexible conduit clamp
- 1 Cover plate
- 1 Magnetic Grille

1.855.663.5600 | www.soundtube.com

UL Listed _____

© 2020 MSE Audio, and SoundTube Entertainment, Inc. All rights reserved. PN INS-CM-BGM-II | Rev 07.02.2020

Warning/Avertissement

SoundTube speakers must be installed by a professional audio installer/contractor. For safety and for optimum audio performance, installer must follow all directions issued by SoundTube Entertainment.

Les haut-parleurs SoundTube doivent être installés par un installateur audio professionnel ou un entrepreneur. Pour des raisons de sécurité et de performances audio optimales, l'installateur doit suivre toutes les instructions émises par SoundTube Entertainment.

Warning/Avertissement

Do not spec or install speaker near support beam, ventilation duct or other structure that may interfere with speaker function or dispersion.

N'installez pas à proximité d'une poutre de support, d'un conduit de ventilation ou d'une autre structure susceptible d'interférer avec la fonction ou la dispersion des enceintes.

CM-BGM-II Series

Drop Tile Install Instructions for:

CM52-BGM-II, CM52s-BGM-II, CM62-BGM-II, and CM82-BGM-II

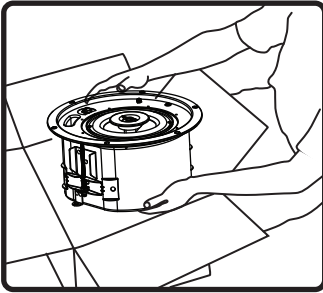

1. Unpack speaker & set aside grille assembly.

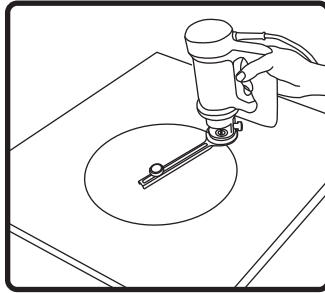

2. Use included tile bridge to mark a circle in the tile. Use Rotozip or other tool to cut hole, and remove cutout portion.

Hole Diameter:
266.7 mm (10.50 in)

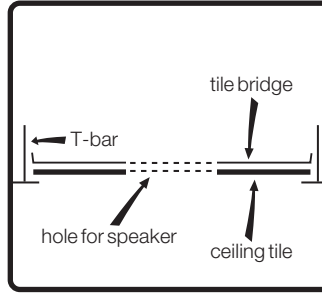

3. Place tile bridge into ceiling grid, then replace ceiling tile.

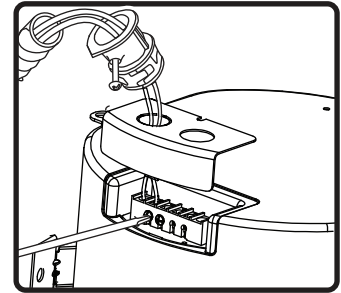

4. Run signal wires through conduit connector, then through cover plate. Connect to ceramic terminal strip. Two + and two - connectors are provided for daisy chaining.

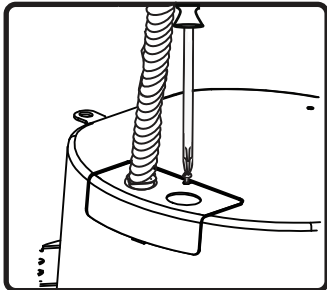

5. Tighten screw on terminal plate, and push conduit connector into knockout.

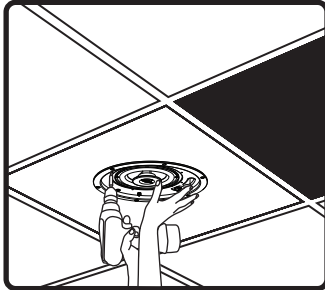

6. Insert speaker into mounting hole. Screw down both bolts on the baffle face to actuate the mounting wings. Firmly secure both bolts – do not over-tighten.

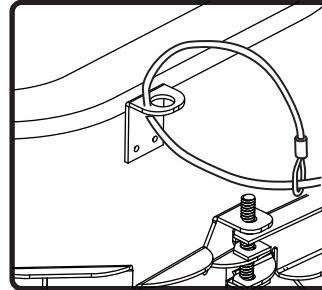

7. If required, a sheet-metal tab located on the rear panel of the speaker serves as a secondary point of attachment (cable not included).

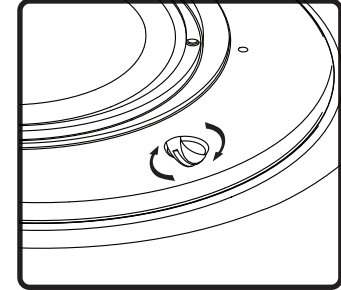

8. Select the tap position by adjusting rotary switch to desired high impedance value or voice coil direct mode.

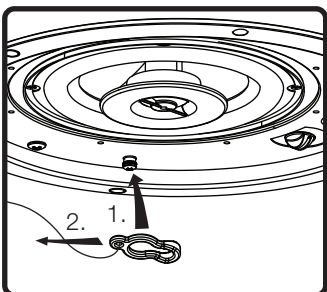

9. Attach grille safety clip by placing the large end of the clip over snap-fit post (1), then sliding clip until small end snaps into place around post (2).

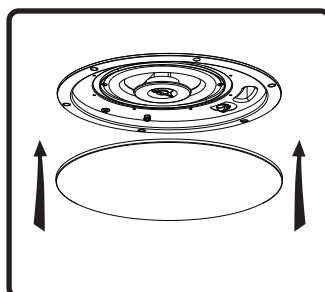

10. Place grille onto baffle. (The grille is held in place by magnets in the baffle.)

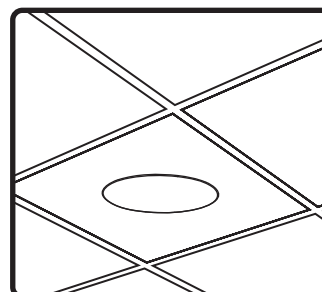

11. Done!

CM-BGM-II Series

Sheetrock Install Instructions for:

CM52-BGM-II, CM52s-BGM-II, CM62-BGM-II, and CM82-BGM-II

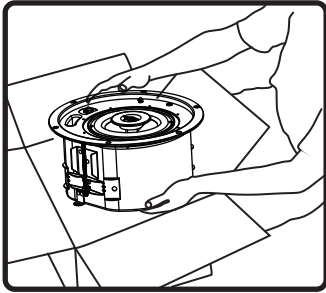

1. Unpack speaker & set aside grille assembly.

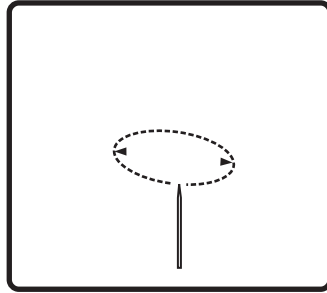

2. Mark cutout in finished sheetrock.

Hole Diameter:
266.7 mm (10.50 in)

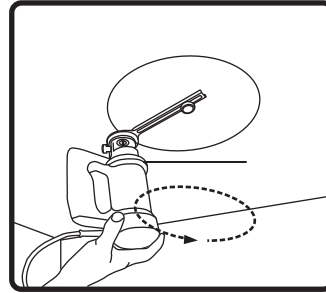

3. Use Rotozip or other tool to cut hole, and remove cutout portion.

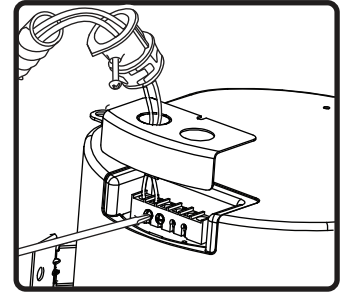

4. Run signal wires through conduit connector, then through cover plate. Connect to ceramic terminal strip. Two + and two - connectors are provided for daisy chaining.

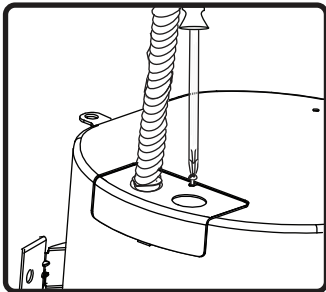

5. Tighten screw on terminal plate, and push conduit connector into knockout.

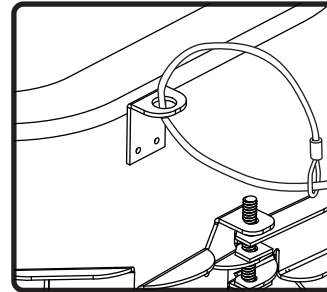

6. If required, a sheet-metal tab located on the rear panel of the speaker serves as a secondary point of attachment (cable not included).

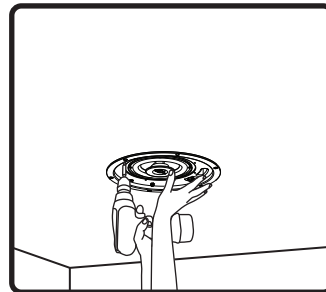

7. Insert speaker into mounting hole. Screw down both bolts on the baffle face to actuate the mounting wings. Firmly secure both bolts – do not over-tighten.

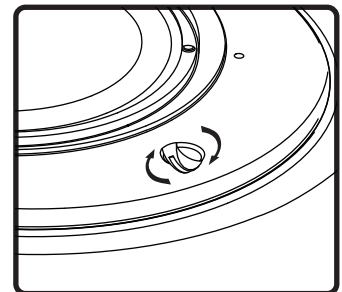

8. Select the tap position by adjusting rotary switch to desired high impedance value or voice coil direct mode.

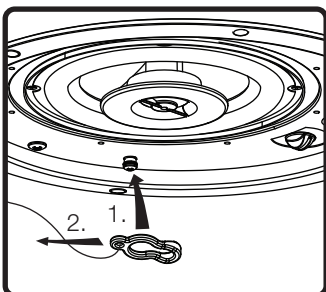

9. Attach grille safety clip by placing the large end of the clip over snap-fit post (1), then sliding clip until small end snaps into place around post (2).

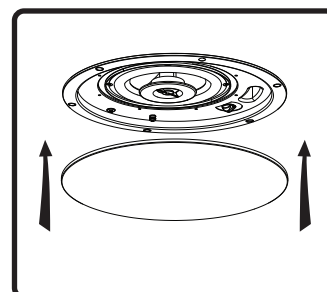

10. Place grille onto baffle. (The grille is held in place by magnets in the baffle.)

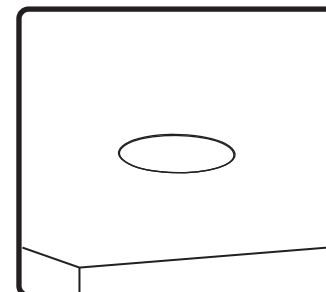

11. Done!

CM-BGM-II Series

Preconstruction Install Instructions for:

CM52-BGM-II, CM52s-BGM-II, CM62-BGM-II, and CM82-BGM-II

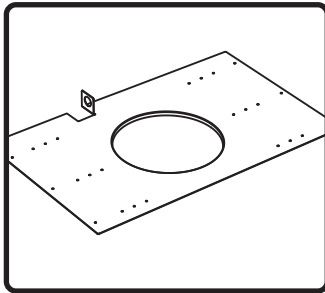

1. Nail or screw preconstruction bracket to joists. Secure conduit/signal wire away from hole in bracket.

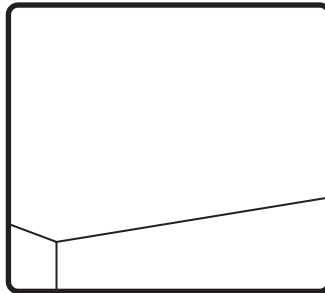

2. Complete Finish work on ceiling.

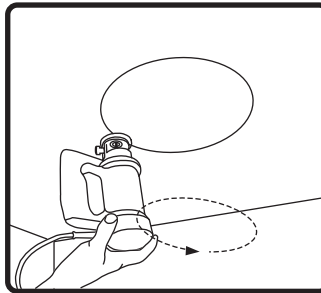

3. Mark cutout area, then use Rotozip or other tool to cut hole, and remove cutout portion.

Hole Diameter:
266.7 mm (10.50 in)

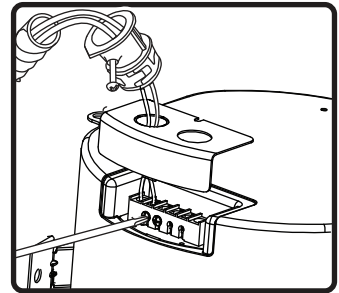

4. Run signal wires through conduit connector, then through cover plate. Connect to ceramic terminal strip. Two + and two - connectors are provided for daisy chaining.

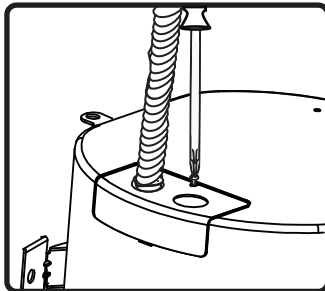

5. Tighten screw on terminal plate, and push conduit connector into knockout.

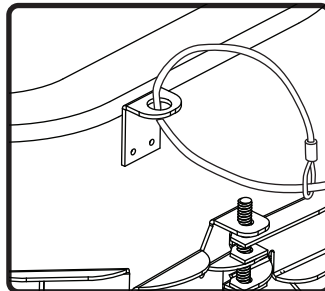

6. If required, a sheet-metal tab located on the rear panel of the speaker serves as a secondary point of attachment (cable not included).

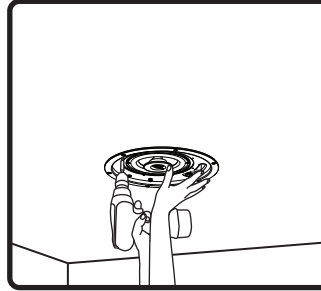

7. Insert speaker into mounting hole. Screw down both bolts on the baffle face to actuate the mounting wings. Firmly secure both bolts – do not over-tighten.

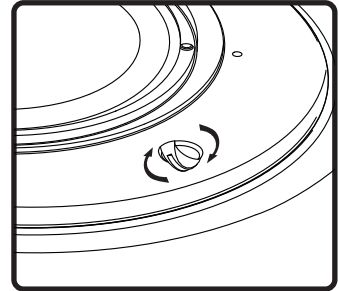

8. Select the tap position by adjusting rotary switch to desired high impedance value or voice coil direct mode.

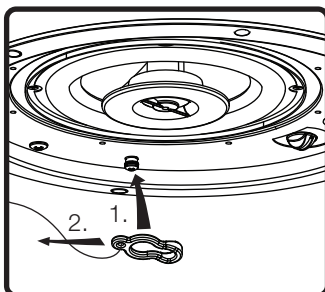

9. Attach grille safety clip by placing the large end of the clip over snap-fit post (1), then sliding clip until small end snaps into place around post (2).

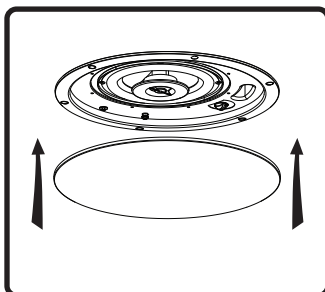

10. Place grille onto baffle. (The grille is held in place by magnets in the baffle.)

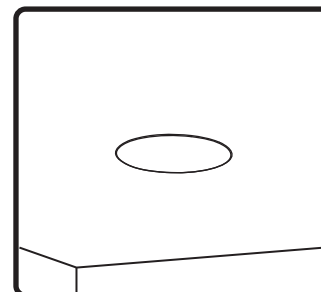

11. Done!