

# MKH 8040 Stereo

Instructions for use

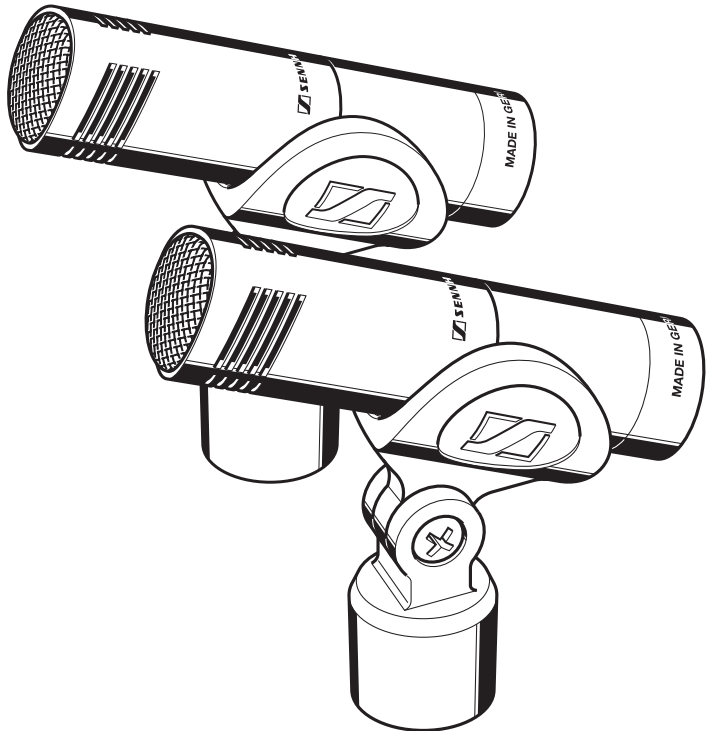



## Contents

Important safety information .....	2
The MKH 8040 .....	3
Delivery includes .....	4
Putting the microphone into operation .....	5
Connecting the microphone .....	5
Attaching the microphone using the microphone clip .....	5
Using the windshield .....	5
Suitable stereo recording techniques .....	6
Exchanging the microphone head .....	7
Accessories .....	7
Specifications .....	8
Manufacturer Declarations .....	10

Thank you for choosing Sennheiser!

We have designed this product to give you reliable operation over many years. Over 60 years of accumulated expertise in the design and manufacture of high-quality electro-acoustic equipment have made Sennheiser a world-leading company in this field. Please take a few moments to read these instructions carefully, as we want you to enjoy your new Sennheiser products quickly and to the fullest.

## Important safety information

### Notes on these instructions for use

- Please read these instructions carefully and completely before using the microphone.
- Make these instructions easily accessible to all users at all times.
- Always include these instructions when passing the microphone on to third parties.

### Before putting the microphone into operation

- Never open the microphone. If devices are opened by customers in breach of this instruction, the warranty becomes null and void.

### During operation

- Water entering the housing of the microphone can cause a short-circuit and damage the electronics. Protect the microphone from wetness. Use only a slightly damp cloth to clean the microphone.
- Do not expose the microphone to extreme temperatures (normal operating temperatures: 10 °C to 35 °C).

### After operation

- Use the microphone with care and store it in a clean, dust-free environment.

### Intended use of the microphone

Intended use includes:

- having read these instructions, especially the chapter "Important safety information" on page 2,
- using the microphone within the operating conditions and limitations described in this instruction manual.

"Improper use" means using the microphone other than as described in these instructions, or under operating conditions which differ from those described herein.

## The MKH 8040

The MKH 8040 is a high-end cardioid studio condenser microphone from the modular MKH 8000 microphone series. This series has the following features:

- Exceptionally low inherent self-noise prevents masking of filigree sound structures
- Symmetrical transducer technology ensures extremely low distortion
- Extremely wide frequency response for an optimum resolution of the finest details
- Transformerless and fully floating balanced output provides for easy connection at minimal distortion
- High sensitivity ensures interference-free transmission with a high signal voltage
- Frequency independent directional characteristics for minimum colouration in the direct and diffuse field
- Rugged metal housing with non-reflective Nextel coating, making the microphone the ideal choice for in-vision use
- Compact design and small diameter allow the unobtrusive positioning of the microphone, even close to instruments
- Modular design provides for easy exchange of the microphone heads and the use of specially-tailored accessories to suit every application

## Delivery includes

- 2 x microphone, consisting of
  - MKH 8040 microphone head and
  - MZX 8000 XLR module
- 2 x MZQ 8000 microphone clip
- 2 x MZW 8000 double-layered windshield
- 1 x carrying case
- 1 x instructions for use

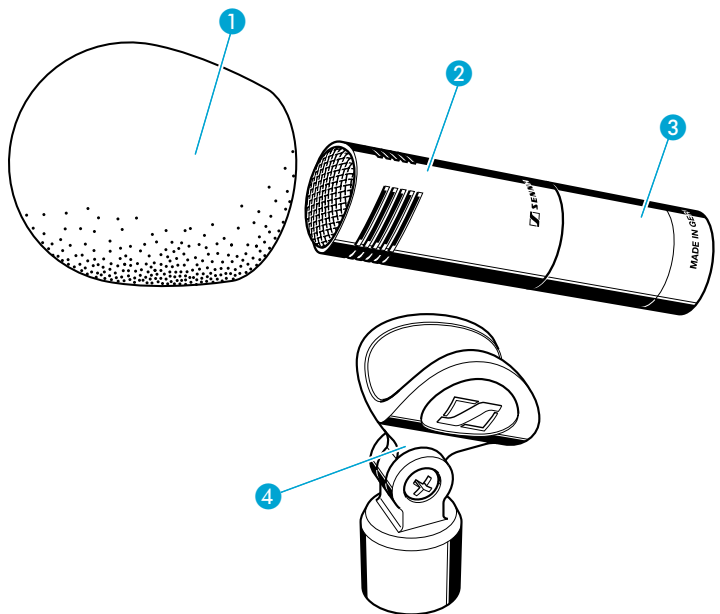

- ① Windshield, double-layered
- ② Microphone head
- ③ XLR module
- ④ Microphone clip (thread adaptor included for 3/8" and 5/8" threads)

# Putting the microphone into operation

## Connecting the microphone

Connection data of the MKH 8020:

- 48 V (+/- 4 V) phantom powering (as per DIN 45596)
  - XLR-3
  - balanced
  - 25  $\Omega$  impedance
  - 1000  $\Omega$  min. terminating impedance
- ▶ Use a microphone cable with XLR-3 connector to connect the microphone to the sound recording device. The sound recording device must provide 48 V phantom powering.

## Attaching the microphone using the microphone clip

- ▶ Select the suitable mounting thread:
- Without thread insert: 5/8" thread
  - Thread insert: 3/8" thread
- ▶ Screw the microphone clip ④ to a floor or table stand.
- ▶ Place the microphone into the microphone clip.

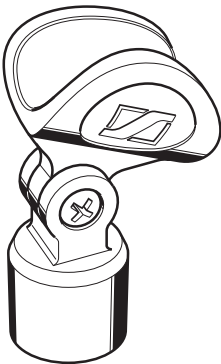

## Using the windshield

- ▶ Slide on the wind shield ① to minimize wind noise. The wind shield changes the sound only slightly, but attenuates wind noise by approx. 30 dB.

## Suitable stereo recording techniques

The microphones are especially suitable for the following stereo recording techniques:

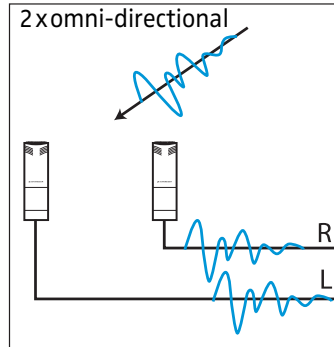

Time-of-arrival stereo (AB):  
(almost) only time-of-arrival differences

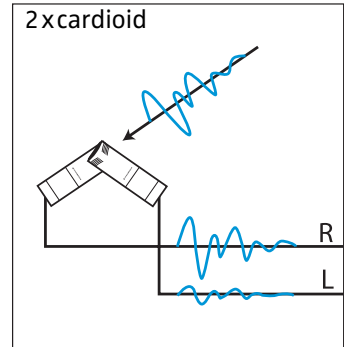

Intensity stereo (XY): only  
sound pressure level differences

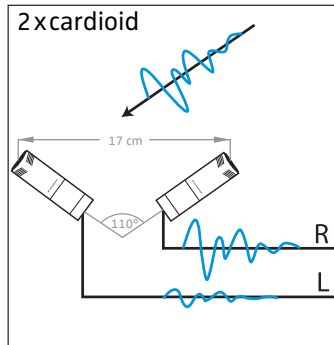

Equivalence or mixed stereo  
(here: ORTF): sound pressure  
level and time-of-arrival  
differences

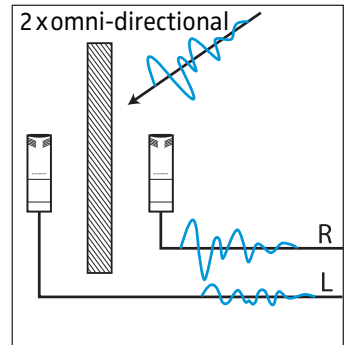

Baffle stereo (here: OSS):  
sound pressure level, time-  
of-arrival and spectral  
differences with off-axis  
sound



## Exchanging the microphone head

You can retrofit the microphones of the modular MKH 8000 series by exchanging the microphone head.

- ▶ Unscrew the microphone capsule ② from the XLR module ③.
- ▶ Screw the new microphone head ② to the XLR module ③.

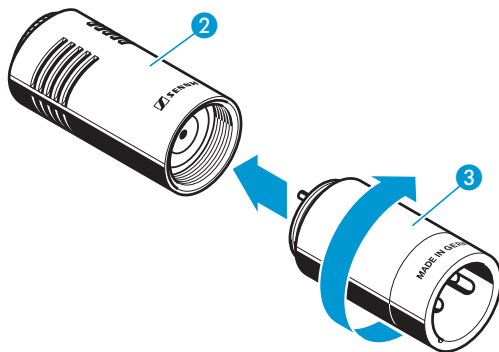

## Accessories

Cat. No.	Accessories/Spare parts
502094	MKHC 8020: Microphone head, omni-directional
502095	MKHC 8040: Microphone head, cardioid
502096	MKHC 8050: Microphone head, super-cardioid
502098	MZX 8000: XLR module
502333	MZW 8000: Windshield, double-layered
502315	MZE 8015: Extension tube, 15 cm
502433	MZE 8030: Extension tube, 30 cm
502316	MZE 8060: Extension tube, 60 cm
502317	MZE 8120: Extension tube, 120 cm
502434	MZEF 8030: Vertical bar, 30 cm

Cat. No.	Accessories/Spare parts	
502318	MZEF 8060:	Vertical bar, 60 cm
502319	MZEF 8120:	Vertical bar, 120 cm
502322	MZFS 8000:	Floor stand
502323	MZG 8000:	Swivel joint
502324	MZGE 8000:	Bar connector, mono
502325	MZGE 8002:	Bar connector, stereo
502326	MZL 8003:	Remote cable, 3 m
502327	MZL 8010:	Remote cable, 10 m
502328	MZQ 8000:	Microphone clip
502329	MZQ 8001:	Mini clip
502330	MZS 8000:	Shock mount
502331	MZT 8000:	Metal table stand
502332	MZT 8001:	Table stand with acrylic base
502435	MZH 8000:	Ceiling mount

## Specifications

Pick-up pattern	cardioid
Frequency response	35 Hz – 50 kHz
Sensitivity	–34 dBV/Pa (20 mV/Pa)
Max. sound pressure level	142 dB SPL
Equivalent noise level	13 dB(A) (DIN 651) 22 dB (CCIR 268-3)
Power supply	48 V (P48) phantom powering
Current consumption	3.3 mA
Diameter	19 mm
Length	41 mm (75 mm with MZX 8000)
Weight	25 g (55 g with MZX 8000)
Temperature range	–10 °C to +60 °C

## Polar diagram

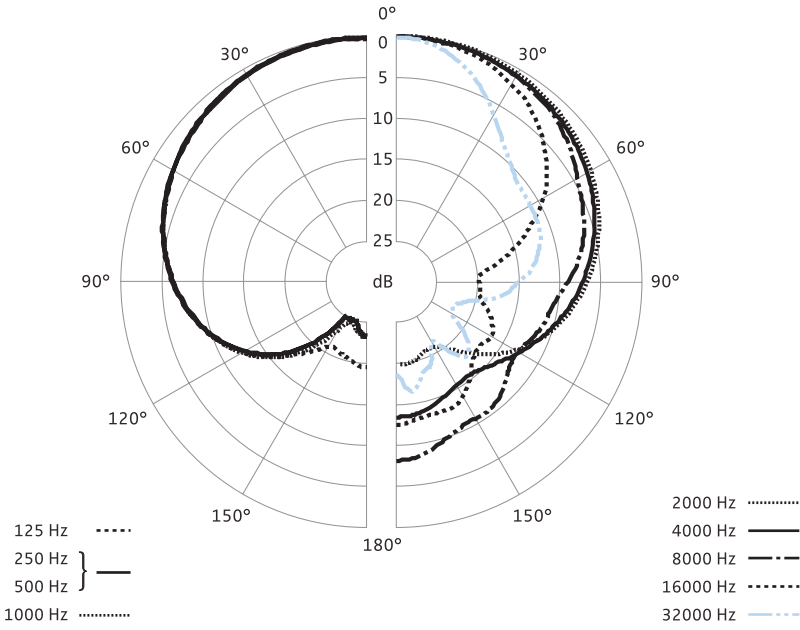

## Frequency response curve

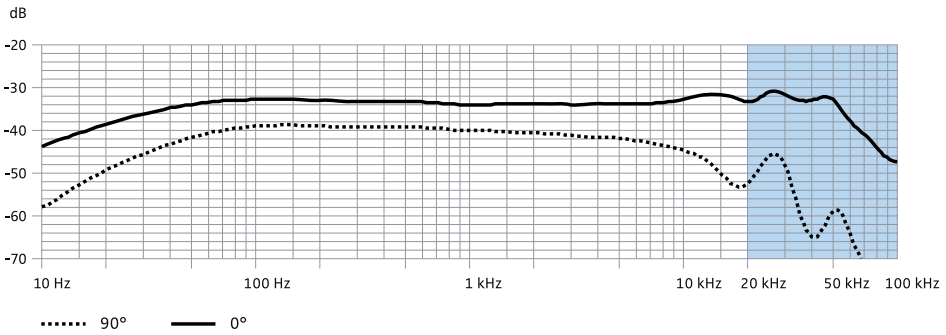

# Manufacturer Declarations

## Warranty

2 years

## CE Declaration of Conformity

**CE 0682**

Sennheiser electronic GmbH & Co. KG declare that this device is in compliance with the essential requirements and other relevant provisions of Directive 89/336/EU.

## WEEE Declaration



Please dispose of this product at the end of its operational lifetime by taking it to your local collection point or recycling centre for such equipment.



Sennheiser electronic GmbH & Co. KG  
30900 Wedemark, Germany  
Phone +49 (5130) 600 0  
Fax +49 (5130) 600 300  
[www.sennheiser.com](http://www.sennheiser.com)

Printed in Germany

Publ. 06/07

524139/A01