

# ETC Setup Guide

## Response Mk2 DIN Rail Gateway

This guide covers installation and basic setup of the Response Mk2 DIN Rail Gateway. You can configure additional software features using ETC Concert software. Reference the Help system built into Concert for more information. ETC Concert software can be found at [etcconnect.com/Concert](http://etcconnect.com/Concert).

### Overview

The DIN rail gateway comes with one, two, or four ports.

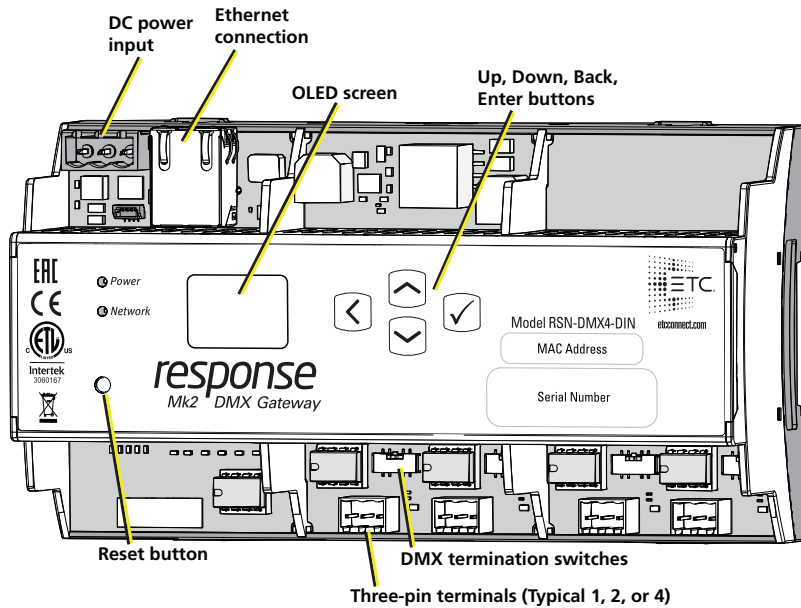

### Action Buttons

- Up, Down, Back buttons - The Back button allows you to return to the previous menu or option and the Up and Down buttons navigate between menu options
- Enter - The Enter button allows you to advance to the next available menu option or commit a modified selection
- Reset - The Reset button provides a physical button to reset the gateway

### LED Indicators

- Power - Solid blue indicates that power is supplied
- Network - Solid green indicates network connection and blinking indicates network activity



# ETC Setup Guide

## DIN Rail Gateway

---

### Electrical Specifications

The gateways are powered by either auxiliary power or Power over Ethernet (PoE).

- Auxiliary power input rated voltage of 12-24 VDC, 6.49 W Max
- 10/100Base-T, PoE power Class 2 (IEEE 802.3af)

For auxiliary power, the DIN rail gateway uses a three-position screw clamp terminal block.

If you supply both PoE and auxiliary power, the gateway defaults to using auxiliary. If auxiliary power is lost, the gateway will reboot and then begin using PoE.



**Note:** *If you are using an external power supply, it must be rated at a maximum of 15 watts.*

---

### DMX Connection

The Response Mk2 Gateways send and receive DMX-512 control signals. DMX cables must be acceptable for DMX data transmission and connections should follow the standard pinouts per the chart below.

The DIN rail gateway comes with one, two, or four terminal connectors.

#### Pinout

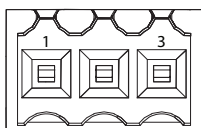

**DMX-512 Pinouts for Terminal Header**

Pin	Use	Typical Wire Color
1	Common (shield)	clear/shield
2	Data -	black
3	Data +	red

# ETC Setup Guide

## DIN Rail Gateway

### Wiring the Terminal Connector

The terminal header can accept two types of connectors (both connector types are provided with the gateway):

- **DMX Cable** (three-position screw connector used with Belden 9729 or equivalent cable)
- **DMX Cat5** (three-position Cat5 insulation displacement connector used with Cat5 or equivalent cable)

### DMX Cable Preparation and Termination



**Note:** Not for use with Cat5, Cat5e, or Cat6 cable. When running DMX with these cable types, use the provided 3-position IDC connector and reference [DMX Cat5 Preparation and Termination on the next page](#).

This instruction assumes preparation of Belden 9729 (or equivalent) cable for termination to the three-position screw terminal connector provided.

1. Install the cable so there is an 20 cm (8 in) service loop available at the rear of the gateway.
2. Strip 18 cm (7 in) off the outer jacket.
3. Label the cable with the data type and run designation. (DMX1, DMX2, etc.)
4. Strip the foil shielding from each wire set to within 6 mm (1/4 in) of the outer jacket.
5. Untwist the shield wire from each pair and apply a piece of 1.6 mm (1/16 in) clear heat shrink to each shield wire.
6. Twist each shield wire back onto its data pair, and then apply a 4 cm (1.5 in) piece of 0.5 cm (3/16 in) heat shrink all the way down each 3-wire set. Make sure to capture the foil shielding at the base.
7. Apply the 5 cm (2 in) piece of the 1 cm (3/8 in) heat shrink, centered on the end of the cable jacket and the bases of all the wires in the cable.
8. Cap the ends of the unused pair of wires with a 2.5 cm (1 in) piece of 0.5 cm (3/16 in) heat shrink centered over the end of the wires.
9. Strip 6 mm (1/4 in) of insulation from all of the wires to be used.
10. Maintain the wire pair twist as close to the screw terminal connector as possible and terminate the wires.
  - a. Insert the common (shield) wire into the terminal labeled "DMX -" and secure.
  - b. Insert the data - wire (typically black) into the terminal labeled "DMX -" and secure.
  - c. Insert the data + wire (typically red or white) into the terminal labeled "DMX +" and secure.
11. Bend back the unused set of wires and secure them to the cable with a wire tie.
12. Secure the terminated wire sets together with a wire tie 5 cm (2 in) from the connector.

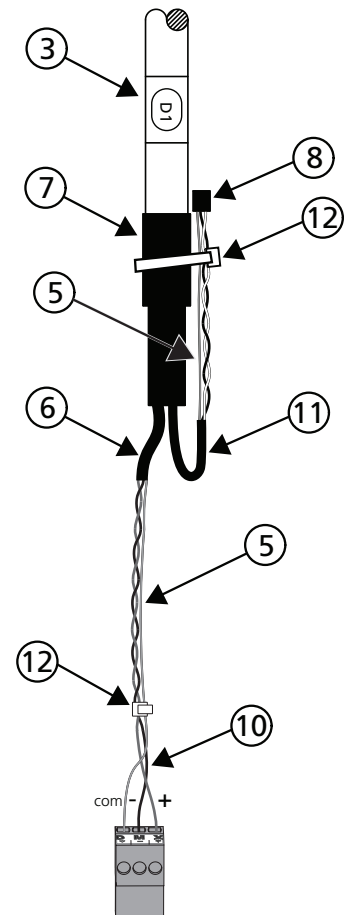

# ETC Setup Guide

## DIN Rail Gateway

---

### DMX Cat5 Preparation and Termination

This instruction assumes use of Cat5 (or equivalent) cable for termination to the three-position Cat5 insulation displacement connector provided in the termination kit.

1. Follow normal Cat5 wire installation procedures to remove 5 cm (2 in) from the end of the cable jacket.
2. Separate the White/Brown, Orange, and White/Orange conductors from the cable. These conductors are required for DMX out.
3. Cut the remaining unused conductors from the cable flush to the cable jacket.
4. Label the cable with the data type and run designation (for example D1 for DMX run 1).
5. Twist the White/Orange and Orange conductors as close to the 3-position IDC as possible and insert the conductors through the labeled terminals as follows:
  - Common (White/Brown) to terminal 1
  - Data - (Orange) to terminal 2
  - Data + (White/Orange) to terminal 3
6. Fully depress each terminal, closing it onto the wire.
7. Use side-cutters to trim the excess wire from the connector.

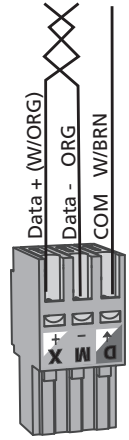

### DMX Termination

Termination is required for all DMX systems and belongs at the source (beginning) of a DMX line and at the last device physically connected in the line. A termination switch is located above the terminal header for each port and can be configured for DMX termination (IN), No termination (OFF) or RDM termination (OUT).

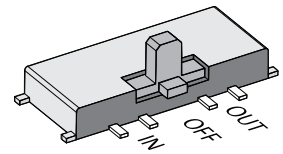

### About RDM

Remote Device Management (RDM, ANSI E1.20) is a protocol enhancement to DMX-512 that allows bidirectional communication between a lighting system controller and attached RDM-compliant responder devices over a standard DMX line. This protocol allows configuration, status monitoring, and management of these devices.

An RDM Controller is the device that initiates communication with one or more RDM Responder devices. Examples of responders are RDM-enabled edge devices such as color scrollers, dimmers, moving lights, and LED fixtures. Compliant DMX-512 and DMX-512-A devices (non-RDM devices) are fully functional when RDM is present. The Response Mk2 Gateway supports up to 256 total RDM devices across its ports using standard DMX system design practices.



**Note:** RDM is currently only supported on DMX Output ports.

---

### RDM Basics

By default, RDM discovery is not enabled on the gateway. To enable RDM on the gateway, use the ETC Concert software or the user interface on the front of the gateway. Please see the Concert online help files for more information on activating RDM on your gateways or see [Configure RDM Settings on page 7](#).

# ETC Setup Guide

## DIN Rail Gateway

### Installation



**Note:** Installation must follow all national and local codes for electrical equipment.

#### DIN rail Mount

To install to the DIN rail, perform the following steps:

1. Ensure the section of DIN rail to be used is mounted securely according to the manufacturer's requirements.
2. Hook the top of the gateway over the upper DIN rail edge as shown.
3. Depress until the bottom clip on the gateway seats completely onto the DIN rail.

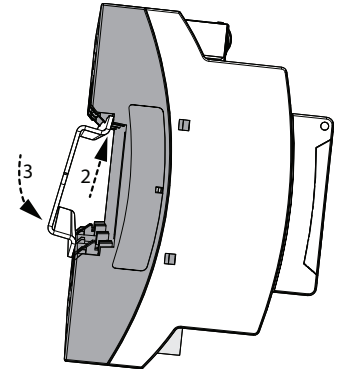

#### Removal from DIN Rail

To remove the gateway from the DIN rail, insert a small screwdriver into the orange retaining clips on the top of the gateway and push the screwdriver down to open the clips. Insert the screwdriver into the bottom retaining clips and push up to fully release the gateway from the DIN rail.

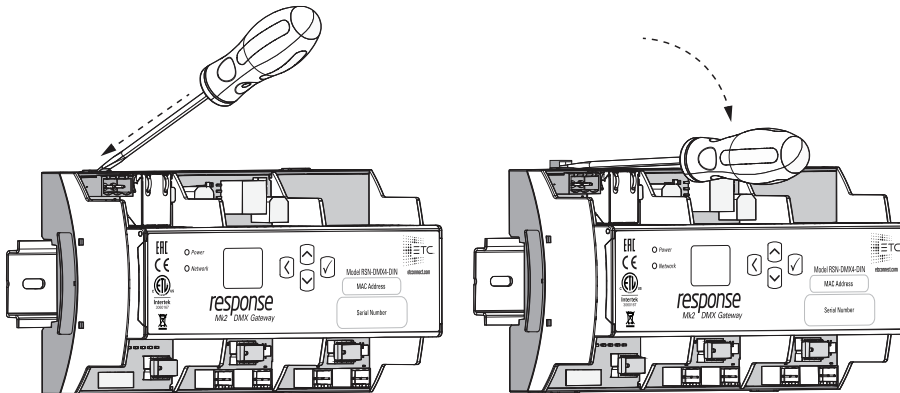

#### Wiring Auxiliary Power

If you are using auxiliary power for your DIN rail gateway, consider the following specifications for the three position screw clamp terminal connector:

- Strip length: 6 mm (1/4 in)
- Torque: Max 0.5 Nm (4.4 lb-in)
- Wire size: 0.5 mm<sup>2</sup> - 4 mm<sup>2</sup> (22-12 AWG)

To wire auxiliary power, perform the following steps:

1. Run the positive/negative DC and ground wires to your gateway, leaving at least a 300 mm (12 in) tail.
2. Strip 6 mm (3/16 in) of insulation from the ends of the incoming wires.
3. Insert the positive wire into the left hand screw terminal and tighten the terminal screw.
4. Insert the negative wire into the middle terminal of the connector and tighten the terminal screw.
5. Insert the ground wire into the right hand screw terminal and tighten the terminal screw.
6. Install the connector to the port on the front of the gateway.

# ETC Setup Guide

## DIN Rail Gateway

### Gateway User Interface and Configuration

The following sections provide information on basic tasks and configuration that you can perform from the user interface of the gateway. These tasks and additional configuration can all be performed using the ETC Concert application, available from [etconnect.com](http://etconnect.com).

#### Home Screen Information

The initial screen that your gateway displays is the Home screen, which provides the name of the gateway, the IP address and some basic port information. This image is what a typical home screen might look like on a four-port gateway, where the gateway name is DMX Gateway and IP address is 10.101.101.101.

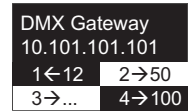

Additionally, the port information provides the following:

- Port 1 is *actively* (black background) *receiving* (left-facing arrow) DMX input and sending it to universe 12.
- Port 2 is *not actively* (white background) *outputting* (right-facing arrow) DMX from universe 50. If an inactive port is in data-loss behavior, such as holding, the port number is appended with an asterisk.
- Port 3 is not actively outputting DMX and *either has a universe above 999 or is split*. The ellipsis (...) indicates additional information that can be viewed from the About screen.
- Port 4 is actively outputting DMX from universe 100.
- Additionally, **DD** indicates a dimmer-doubled port, **AIP** indicates Advanced Input Patch, **^** indicates a port in downloader mode, and **X** indicates a disabled port.



Pressing the **Enter** button from the Home screen brings up three selectable menu options (**About**, **Setup**, **Operations**) from which you can access other information or configuration options.

If you receive a **User Interface Locked** message when accessing the **Setup** or **Operations** options, the gateway UI is locked. To unlock the UI, you must use the ETC Concert software.

#### View Device Information

To view information specific to your gateway, select the **About** menu option from the Home screen. From the About screen, you can select one of the following four options and then view the information specific to that option:

General	View Levels	Port Info	RDM Info
Ver: 1.0.0.12 FPGA: 1.0.0 Network	Port 1 Channel 1 State Active Level 127(50%)	Port 1 Mode Output U: 63999 Speed Max	Port 1 RDM Enabled Background Off Devices 128

#### Configure Network Settings

1. From the Home screen, select **Setup** > **Network**.
2. From the Mode screen, use the **Up** and **Down** buttons to select **Manual**, **Link Local** or **Automatic**.
  - **Automatic** attempts to automatically configure the IP Address, IP Subnet and IP Gateway for your device via DHCP.
  - If you select **Manual**, you must configure the IP Address, IP Subnet and IP Gateway screens and then select **OK** from the Apply/Reboot? screen.
  - If you select **Link Local**, the gateway self-assigns an IP address that is valid for the local network in the link-local address range. Select **OK** from the Apply/Reboot? screen.

# ETC Setup Guide

## DIN Rail Gateway

---

### Configure Port Settings

1. From the Home screen, select **Setup > Ports**.
2. Use the **Enter** button to move from the menu options on the left to the values on the right side of the screen. Use the **Up** and **Down** buttons to change the values and press **Enter** again to confirm the change. Using these controls, configure the fields on screen:
  - **Port** - Select the port for which the following values apply:
  - **Mode** - Select the port mode. This can be set to Input, Output or Disabled.
  - **Universe** - Select the Universe of the port (1-63999).
  - **Speed** - Select the speed at which DMX is transmitted. This can be set to Slow, Medium, Fast, and Max.



**Note:** For detailed DMX speed timings, visit:  
[https://support.etconnect.com/ETC/FAQ/DMX\\_Speed](https://support.etconnect.com/ETC/FAQ/DMX_Speed).

---

### Configure RDM Settings

1. From the Home screen, select **Setup > RDM**.
2. Use the **Enter** button to move from the menu options on the left to the values on the right side of the screen. Use the **Up** and **Down** buttons to change the values and press **Enter** again to confirm the change. Using these controls, configure the fields on screen:
  - **Port** - Select the port for which the following values apply:
  - **RDM** - Select whether RDM is enabled or disabled on the port.
  - **Background** - Select whether background discovery and polling of RDM is on or off.

### Configure Data Loss Settings

1. From the Home screen, select **Setup > Data Loss**.
2. Use the **Enter** button to move from the menu options on the left to the values on the right side of the screen. Use the **Up** and **Down** buttons to change the values and press **Enter** again to confirm the change. Using these controls, configure the fields on screen:
  - **Port** - Select the port for which the following values apply:
  - **HLLF** - Select whether Hold Last Look Forever (HLLF) is on or off. Selecting **On** enables Hold Last Look Forever. Additional configuration options for hold last look are available in Concert.

# ETC Setup Guide

## DIN Rail Gateway

---

### Restore Default Settings

To restore the factory defaults for your device, select the Operations menu from the home screen and choose the **Restore Defaults** option. This removes all network and master/backup information that is configured for your gateway but retains the gateway name.

```
Restore Defaults
All data
will be lost
OK?
```

### Update Software

The recommended method of updating the gateway is through UpdaterAtor. The UpdaterAtor application is available for download at [etconnect.com](http://etconnect.com).

There is also an option to update the software from the gateway using a TFTP server like Conductor. To upgrade the software, select the Operations menu from the home screen and choose the **Update Software** option. If you do choose to update directly from the gateway, the bootloader runs and the latest software is downloaded from the server indicated by the <#.#.#.#> IP address on the Update Software screen. If you need to modify this IP address, you can configure it in the Concert application using the **Update Server** property.

```
Update Software
from server
10.101.50.60
OK?
```



**Note:** Regardless of whether you update from UpdaterAtor or directly from the gateway, the device must be on the network.

---

### Test Port Output

You can test DMX outputs by selecting **Operations > Test Output** from the Home screen.

---



**CAUTION:** Testing outputs drives all DMX levels to full. Use with caution in a show situation or when controlling high current devices.

---

```
Port      1
State     -
Release All
```

This screen allows you to test the output for any port on your gateway.

- **Port** - Press the **Enter** button to select and then use the **Up** and **Down** buttons to cycle through the ports of your gateway. Press **Enter** again to select the port.
- **State** - Press **Enter** to select and then use the **Up** and **Down** buttons to cycle through the test state options. If the port is an input, this field displays either Input or Disabled. If the port is an output, you can select either Released (--), Full or All Zero.
- **Release All** - Press the **Enter** button to release the test state on all ports. Once outputs are set into a test state they can be released from this menu, from Concert or by rebooting the gateway.



**Note:** This product uses licensed software provided by third parties. Please visit <http://www.etconnect.com/licenses/> for licensing information.

---