

PROPAR

cob



Blizzard Lighting, LLC
<http://www.blizzardpro.com>
Waukesha, WI USA
Copyright (c) 2019

TABLE OF CONTENTS

ProPar™ COB LED Par Can	1
1. Getting Started	3
What's In The Box?	3
Getting It Out Of The Box	3
Powering Up!	3
Getting A Hold Of Us	3
Safety Instructions (Don't Stick Your Hand In The Toaster!)	4
2. Meet The ProPar ProPar™ COB LED Par	5
Main Features	5
DMX Quick Reference	5
The ProPar™ COB Pin-up Picture	6
3. Setup	7
Fuse Replacement	7
Connecting A Bunch Of ProPar™ COB Fixtures	7
Data/DMX Cables	7
Cable Connectors	8
3-Pin??? 5-Pin??? Huh?	8
Take It To The Next Level: Setting up DMX Control	8
Fixture Linking (Master/Slave Mode)	9
Mounting/Rigging	9
4. Operating Adjustments	10
Navigating The Control Panel	10
Control Panel Menu Structure	11
DMX Mode	12
Set the Starting DMX Address	12
Select the DMX Channel Mode	12
Slave Mode	12
Auto Mode	12
Sound Active Mode	12
Static Colors	12
Manual Color Adjustment	13
DMX Channel Values In-Depth	13
Troubleshooting	13
5. Appendix	14
A Quick DMX Lesson	14
Keeping Your ProPar™ COB As Good As New	15
Returns (Gasp!)	15
Shipping Issues	16
Tech Specs	16
Dimensional Drawings	16

1. GETTING STARTED

What's In The Box?

- 1 x ProPar™ COB Professional LED Fixture
- An Ever-So-Handy Power Cord
- This Lovely User Manual

Optional Accessories *(sold separately)*

The following accessories are available for this fixture. But the lone wolves that they are, must be purchased separately. Contact an authorized Blizzard Lighting dealer for pricing!

- BARNDOOR-PROPAR COB: Barndoor attachment

Getting It Out Of The Box

Congratulations on your purchase of the way cool ProPar™ COB LED fixture! Now that you've got your ProPar™ COB (*or hopefully, COBs*), you should carefully unpack the box and check the contents to ensure that all parts are present and in good condition. If anything looks as if it has been damaged in transit, notify the shipper immediately and keep the packing material for inspection. Again, please save the carton and all packing materials. If a fixture must be returned to the factory, it is important that the fixture be returned in the original factory box and packing.

Powering Up!

All fixtures must be powered directly off a switched circuit and **cannot be run off a rheostat (variable resistor) or dimmer circuit, even if the rheostat or dimmer channel is used solely for a 0% to 100% switch.**

AC Voltage Switch - Not all fixtures have a voltage select switch, so please verify that the fixture you receive is suitable for your local power supply. See the label on the fixture or refer to the fixture's specifications chart for more information. A fixture's listed current rating is its average current draw under normal conditions. Check the fixture or device carefully to make sure that if a voltage selection switch exists that it is set to the correct line voltage you will use.

Warning! Verify that the voltage select switch on your unit matches the line voltage applied. Damage to your fixture may result if the line voltage applied does not match the voltage indicated on the voltage selector switch. All fixtures must be connected to circuits with a suitable Ground (Earthing).

Getting A Hold Of Us

If something is wrong, please just visit our website at www.blizzardpro.com/ support and open a support ticket. We'll be happy to help, honest.

Disclaimer: The information and specifications contained in this document are subject to change without notice. Blizzard Lighting™ assumes no responsibility or liability for any errors or omissions that may appear in this user manual. Blizzard Lighting™ reserves the right to update the existing document or to create a new document to correct any errors or omissions at any time. You can download the latest version of this document from www.blizzardpro.com.

Author:	Date:	Last Edited:	Date:
J. Thomas	11/21/2016	J. Thomas	5/8/2019

SAFETY INSTRUCTIONS



Please read these instructions carefully. They include important information about the installation, usage and maintenance of this product.

- Please keep this User Guide for future use. If you sell the unit to someone else, be sure that they also receive this User Guide.
- ALWAYS make sure that you are connecting to the proper voltage, and that the line voltage you are connecting to is not higher than that stated on the decal or rear panel of the fixture.
- This product is intended for indoor use only.
- To prevent risk of fire or shock, do not expose fixture to rain or moisture.
- Make sure there are no flammable materials close to the unit while operating.
- The unit must be installed in a location with adequate ventilation, at least 20in (50cm) from adjacent surfaces. Be sure that no ventilation slots are blocked.
- ALWAYS disconnect from the power source before servicing or replacing fuse and be sure to replace with same fuse size and type.
- ALWAYS secure fixture using a safety chain. NEVER carry the fixture by its head. Use its carrying handles.
- DO NOT operate at ambient temperatures higher than 104°F (40°C).
- In the event of a serious operating problem, stop using the unit immediately. NEVER try to repair the unit by yourself. Repairs carried out by unskilled people can lead to damage or malfunction. Please contact the nearest authorized technical assistance center. Always use the same type spare parts.
- NEVER connect the device to a dimmer pack.
- Make sure the power cord is never crimped or damaged.
- Never disconnect the power cord by pulling or tugging on the cord.
- Avoid direct eye exposure to the light source while it is on.

Caution! There are no user serviceable parts inside the unit. Do not open the housing or attempt any repairs yourself. In the unlikely event your unit may require service, please open a support ticket at www.blizzardpro.com/support.

2. MEET THE PROPAR™ COB LED PAR

MAIN FEATURES:

- Light source: 200W RGB COB LED, 100,000 hours
- User selectable 3 or 6 DMX channel modes
- RGB color mixing in standalone, master/slave and DMX modes
- Built-in auto programs via master/slave, standalone
- Built-in sound activate modes via master/slave, standalone
- Easy to use LED digital control panel
- 5-pin DMX input/output
- Dual mounting yoke allows flexibility in positioning
- Rear downrod mounting point connection
- Heavy-duty composite housing
- Optional barndoor available (sold separately)
- PowerCon™ compatible AC power In/Out

OPTICAL:

- Flicker Free, constant current LED driver (1.2KHZ dimming)
- Beam Angle: 45°
- 11,790 Lux @ 1m, 2,904 Lux @ 2m (full white)

CONTROL:

- USITT DMX-512 (3/6-channels)
- 4-button LED control panel
- 5-pin DMX input/output connections

DMX Quick Reference (6-Channel Mode)

Channel	What It Does
1	Dimmer
2	Red Intensity
3	Green Intensity
4	Blue Intensity
5	Strobe / Auto Speed
6	Built-in Programs

DMX Quick Reference (3-Channel Mode)

Channel	What It Does
1	Red Intensity
2	Green Intensity
3	Blue Intensity

Figure 1: The ProPar™ COB Pin-Up Picture



Figure 2: The Rear Connections

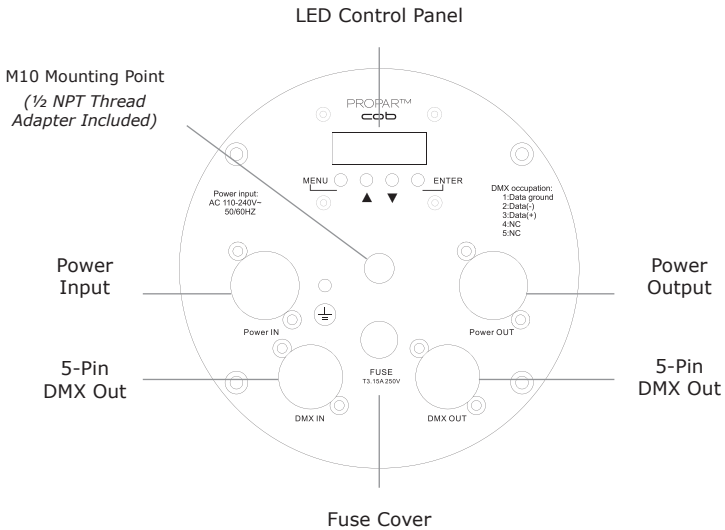

3. SETUP



Before replacing a fuse, disconnect the power cord. ALWAYS replace with the same type and rating of fuse.

Fuse Replacement

Remove the fuse holder from of its housing. Then take out the damaged fuse from its holder and replace with exact same type of fuse. Reattach the fuse holder, and then reconnect power.

Connecting A Bunch of ProPar™ COB Fixtures

You will need a serial data link to run light shows using a DMX-512 controller or to run shows on two or more fixtures set to sync in master/slave operating mode. The combined number of channels required by all the fixtures on a serial data link determines the number of fixtures the data link can support.

Fixtures on a serial data link must be daisy chained in one single line. Also, connecting more than 32 fixtures on one serial data link without the use of a DMX optically-isolated splitter may result in deterioration of the digital DMX signal.

The maximum recommended cable-run distance is 500 meters (1640 ft). The maximum recommended number of fixtures on a serial data link is 32 fixtures.

Data/DMX Cabling

To link fixtures together you'll need data cables. You should use data-grade cables that can carry a high quality signal and are less prone to electromagnetic interference.

For instance, Belden© 9841 meets the specifications for EIA RS-485 applications. Standard microphone cables will "probably" be OK, but note that they cannot transmit DMX data as reliably over long distances. In any event, the cable should have the following characteristics:

- *2-conductor twisted pair plus a shield*
- *Maximum capacitance between conductors – 30 pF/ft.*
- *Maximum capacitance between conductor & shield – 55 pF/ft.*
- *Maximum resistance of 20 ohms / 1000 ft.*
- *Nominal impedance 100 – 140 ohms*

Cable Connectors

Cables must have a male XLR connector on one end and a female XLR connector on the other end. (Duh!)

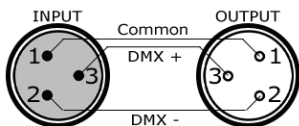

A Word on Termination: DMX is a resilient communication protocol, however errors still occasionally occur. Termination reduces signal errors, and therefore best practices include use of a terminator in all circumstances. If you are experiencing problems with erratic fixture behavior, especially over long signal cable runs, a terminator may help improve performance.

To build your own DMX Terminator:
Obtain a 120-ohm, 1/4-watt resistor, and wire it between pins 2 & 3 of the last fixture. They are also readily available from specialty retailers.

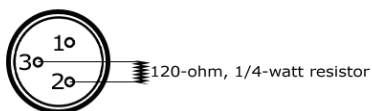

CAUTION: Do not allow contact between the common and the fixture's chassis ground. Grounding the common can cause a ground loop, and your fixture may perform erratically. Test cables with an ohm meter to verify correct polarity and to make sure the pins are not grounded or shorted to the shield or each other.

3-Pin??? 5-Pin??? Huh?!?

If you use a controller with a 5-pin DMX output connector, it's no problem! Just use the installed 5-pin DMX input and/or output connections found on the back of your fixture(s).

Conductor	3-Pin Female (Output)	5-Pin Male (Input)
Ground/Shield	Pin 1	Pin 1
Data 1- (Primary Data Link)	Pin 2	Pin 2
Data 1+ (Primary Data Link)	Pin 3	Pin 3
Data 2- (Optional Secondary Data Link)	Pin 4	Pin 4
Data 2+ (Optional Secondary Data Link)	Pin 5	Pin 5

Take It To The Next Level: Setting Up DMX Control

Step 1: Connect the male connector of the DMX cable to the female connector (output) on the controller.

Step 2: Connect the female connector of the DMX cable to the first fixture's male connector (input). *Note:* It doesn't matter which fixture address is the first one connected. We recommend connecting the fixtures in terms of their proximity to the controller, rather than connecting the lowest fixture number first, and so on.

Step 3: Connect other fixtures in the chain from output to input as above. Place a DMX terminator on the output of the final fixture to ensure best communication.

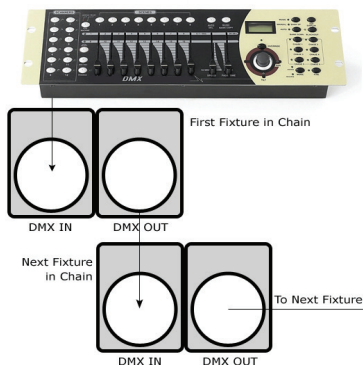

Fixture Linking (Master/Slave Mode)

1. Connect the (male) 3/5-pin connector side of the DMX cable to the output (female) 3/5-pin connector of the first fixture.
2. Connect the end of the cable coming from the first fixture which will have a (female) 3/5-pin connector to the input connector of the next fixture consisting of a (male) 3/5-pin connector. Then, proceed to connect from the output as stated above to the input of the following fixture and so on.

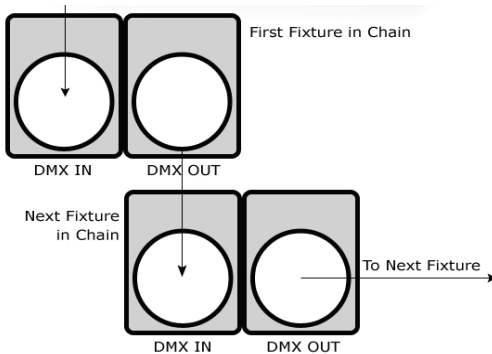

A quick note: Often, the setup for Master-Slave and Standalone operation requires that the first fixture in the chain be initialized for this purpose via either settings in the control panel or DIP-switches. Secondly, the fixtures that follow may also require a slave setting.

Check the **"Operating Adjustments"** section in this manual for complete instructions for this type of setup and configuration.

Mounting & Rigging

This fixture may be mounted in any SAFE position provided there is enough room for ventilation.

It is important never to obstruct the fan or vents pathway. Mount the fixture using a suitable "C" or "O" type clamp. The clamp should be rated to hold at least 10x the fixture's weight to ensure structural stability. Do not mount to surfaces with unknown strength, and ensure properly "rated" rigging is used when mounting fixtures overhead.

Adjust the angle of the fixture by loosening both knobs and tilting the fixture. After finding the desired position, retighten both knobs.

- When selecting installation location, take into consideration lamp replacement access (if applicable) and routine maintenance.
- Safety cables **MUST ALWAYS** be used.
- Never mount in places where the fixture will be exposed to rain, high humidity, extreme temperature changes or restricted ventilation.

4. OPERATING ADJUSTMENTS

The Control Panel

All the goodies and different modes possible with the ProPar™ COB are accessed by using the control panel on the rear of the fixture. There are 4 control buttons below the LED display which allow you to navigate through the various control panel menus.

<MENU>

Is used to navigate to the previous higher-level menu item.

<UP>

Scrolls through menu items and numbers in ascending order.

<DOWN>

Scrolls through menu items and numbers in descending order.

<ENTER>

Is used to select and confirm/store the current selection.

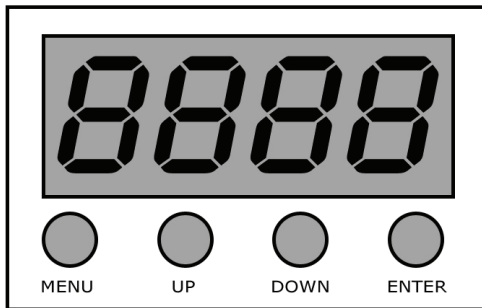

The control panel LED display shows the menu items you select from the menu map on page #11. When a menu function is selected, the display will show immediately the first available option for the selected menu function. To select a menu item, press **<ENTER>**.

Use the **<UP>** and **<DOWN>** buttons to navigate the menu options. Press the **<ENTER>** button to select the menu function currently displayed, or to enable a menu option. To return to the previous option or menu without changing the value, press the **<MENU>** button.

Control Panel Menu Structure

Addr	A001-A512		To choose the starting DMX address of 1-512	
Auto	Aut1		Auto mode 1, select speed 1-9 (slow <--> fast)	
	Aut2		Auto mode 2, select speed 1-9 (slow <--> fast)	
	Aut3		Auto mode 3, select speed 1-9 (slow <--> fast)	
	Aut4		Auto mode 4, select speed 1-9 (slow <--> fast)	
	Aut5		Auto mode 5, select speed 1-9 (slow <--> fast)	
	Aut6		Auto mode 6, select speed 1-9 (slow <--> fast)	
	Aut7		Auto mode 7, select speed 1-9 (slow <--> fast)	
	Aut8		Auto mode 8, select speed 1-9 (slow <--> fast)	
	Aut9		Auto mode 9, select speed 1-9 (slow <--> fast)	
CoLo	CoL1		Color 1	
	CoL2		Color 2	
	CoL3		Color 3	
	CoL4		Color 4	
	CoL5		Color 5	
	CoL6		Color 6	
	CoL7		Color 7	
	CoL8		Color 8	
	CoL9		Color 9	
		AtF	Red	Red intensity (0-255)
	RGB Color Mixing		Gren	Green intensity (0-255)
			Blue	Blue intensity (0-255)
ChAn	3Ch		3-channel DMX mode	
	6Ch		6-channel DMX mode	
Soun	Sou1		Sound active mode 1, select mic sensitivity 1-9	
	Sou2		Sound active mode 2, select mic sensitivity 1-9	
SLAu	SLA		Slave mode	
uEr	xxx		Installed software version information	

DMX Mode

Allows the unit to be controlled by any universal DMX controller.

Set the Starting DMX Address:

- 1.) Navigate the main menu until you reach **Address**, press **<ENTER>**.
- 2.) Use the **<UP/DOWN>** buttons to select a DMX channel from **A001-A512**.
- 3.) Press the **<ENTER>** button to confirm.

Select the DMX Channel Mode:

- 1.) Navigate the main menu until you reach **ChAn**, press **<ENTER>**.
- 2.) Use the **<UP/DOWN>** buttons to select **3CH**, or **6CH**.
- 3.) Press the **<ENTER>** button to confirm your selection.

Slave Mode:

- 1.) Navigate the main menu until you reach **SLAu**, press **<ENTER>**.
- 2.) Use the **<UP/DOWN>** buttons to select **SLA**.
- 3.) Press the **<ENTER>** button to confirm your selection.

Auto, Sound Active, & Manual Adjustments:

Allows a single or Master/Slaved units to run factory installed programs at user selectable speeds.

Auto Mode:

- 1.) Navigate the main menu until you reach **Auto**, press **<ENTER>**.
- 2.) Use the **<UP/DOWN>** buttons to select **Aut1 - Aut9**.
- 3.) Press the **<ENTER>** button to confirm your selection.

Sound Active Mode:

- 1.) Navigate the main menu until you reach **Soun**, press **<ENTER>**.
- 2.) Use the **<UP/DOWN>** buttons to select **Sou1** or **Sou2**.
- 3.) Press the **<ENTER>** button to confirm your selection.
- 4.) You can then choose the mic sensitivity level from **SC-1** thru **SC-9**.
- 5.) Press the **<ENTER>** button to confirm.

Static Colors:

- 1.) Navigate the main menu until you reach **CoLo**, press **<ENTER>**.
- 2.) Use the **<UP/DOWN>** buttons to select **CoL1 - CoL9**.
- 3.) Press the **<ENTER>** button to confirm your selection.

Manual Color Adjustment:

- 1.) Navigate the main menu until you reach **CoLo**, press **<ENTER>**.
- 2.) Use the **<UP/DOWN>** buttons to navigate to **AtF**, press **<ENTER>**.
- 3.) Use the **<UP/DOWN>** buttons highlight **Red**, **Gren**, or **Blue**.
- 4.) Press the **<ENTER>** button to confirm.
- 5.) Press the **<ENTER>** button to save, and the **<MENU>** button to exit.

DMX Values In-Depth (3-Channel Mode)

Channel	Value	What It Does
1	000 <--> 255	Red Intensity (0% <--> 100%)
2	000 <--> 255	Green Intensity (0% <--> 100%)
3	000 <--> 255	Blue Intensity (0% <--> 100%)

DMX Values In-Depth (6-Channel Mode)

Channel	Value	What It Does
1	000 <--> 255	Dimmer (0% <--> 100%)
2	000 <--> 255	Red Intensity (0% <--> 100%)
3	000 <--> 255	Green Intensity (0% <--> 100%)
4	000 <--> 255	Blue Intensity (0% <--> 100%)
5	000 <--> 009 010 <--> 255	Strobe/Auto Speed No Function Strobe / Auto Speed (Slow <--> Fast)
6	000 <--> 015 016 <--> 037 038 <--> 060 061 <--> 083 084 <--> 106 107 <--> 129 130 <--> 152 153 <--> 175 176 <--> 198 199 <--> 221 222 <--> 244 245 <--> 255	Auto, and Sound Active Modes No function Color fade Color slow appear and slow disappear Color change Color slow appear and fast disappear Color slow in and fast out Color strobe in and slow out Color fast in and slow out Color strobe and fade out Color change and strobe Sound Active 1 Sound Active 2

Troubleshooting

Symptom	Solution
No Light Output	Check to ensure fixture is operating under correct mode, IE sound active/auto/DMX/Etc., if applicable.
No Power	Check fuse, AC cord and circuit for malfunction.
Blown Fuse	Check AC cord and circuit for damage.
Slow Movement	Check that speed channels are set appropriately.
No Response to Audio	Verify that the fixture is in "Sound Active" mode. Adjust Audio Sensitivity.
Fixture Not Responding / Responding Erratically	Make sure all connectors are seated properly and securely. Use Only DMX Cables. Install a Terminator. Check all cables for defects. Reset fixture(s).

5. APPENDIX

A Quick Lesson On DMX

DMX (aka DMX-512) was created in 1986 by the United States Institute for Theatre Technology (USITT) as a standardized method for connecting lighting consoles to lighting dimmer modules. It was revised in 1990 and again in 2000 to allow more flexibility. The Entertainment Services and Technology Association (ESTA) has since assumed control over the DMX512 standard. It has also been approved and recognized for ANSI standard classification.

DMX covers (and is an abbreviation for) Digital MultipleXed signals. It is the most common communications standard used by lighting and related stage equipment.

DMX provides up to 512 control "channels" per data link. Each of these channels was originally intended to control lamp dimmer levels. You can think of it as 512 faders on a lighting console, connected to 512 light bulbs. Each slider's position is sent over the data link as an 8-bit number having a value between 0 and 255. The value 0 corresponds to the light bulb being completely off while 255 corresponds to the light bulb being fully on.

DMX data is transmitted at 250,000 bits per second using the RS-485 transmission standard over two wires. As with microphone cables, a grounded cable shield is used to prevent interference with other signals.

There are five pins on a DMX connector: a wire for ground (cable shield), two wires for "Primary" communication which goes from a DMX source to a DMX receiver, and two wires for a "Secondary" communication which goes from a DMX receiver back to a DMX source. Generally, the "Secondary" channel is not used so data flows only from sources to receivers. Hence, most of us are most familiar with DMX-512 as being employer over typical 3-pin "mic cables," although this does not conform to the defined standard.

DMX is connected using a daisy-chain configuration where the source connects to the input of the first device, the output of the first device connects to the input of the next device, and so on. The standard allows for up to 32 devices on a single DMX link.

Each receiving device typically has a means for setting the "starting channel number" that it will respond to. For example, if two 6-channel fixtures are used, the first fixture might be set to start at channel 1 so it would respond to DMX channels 1 through 6, and the next fixture would be set to start at channel 7 so it would respond to channels 7 through 12.

The greatest strength of the DMX communications protocol is that it is very simple and robust. It involves transmitting a reset condition (indicating the start of a new "packet"), a start code, and up to 512 bytes of data. Data packets are transmitted continuously. As soon as one packet is finished, another can begin with no delay if desired (usually another follows within 1 ms). If nothing is changing (i.e. no lamp levels change) the same data will be sent out over and over again. This is a great feature of DMX -- if for some reason the data is not interpreted the first time around, it will be re-sent shortly.

Not all 512 channels need to be output per packet, and in fact, it is very uncommon to find all 512 used. The fewer channels are used, the higher the "refresh" rate. It is possible to get DMX refreshes at around 1000 times per second if only 24 channels are being transmitted. If all 512 channels are being transmitted, the refresh rate is around 44 times per second.

In summary, since its design and evolution in the 1980's DMX has become the standard for lighting control. It is flexible, robust, and scalable, and its ability to control everything from dimmer packs to moving lights to foggers to lasers makes it an indispensable tool for any lighting designer or lighting performer.

Keeping Your ProPar™ COB As Good As New

The fixture you've received is a rugged, tough piece of pro lighting equipment, and as long as you take care of it, it will take care of you. That said, like anything, you'll need to take care of it if you want it to operate as designed. You should absolutely keep the fixture clean, especially if you are using it in an environment with a lot of dust, fog, haze, wild animals, wild teenagers or spilled drinks.

Cleaning the optics routinely with a suitable glass cleaner will greatly improve the quality of light output. Keeping the fans free of dust and debris will keep the fixture running cool and prevent damage from overheating.

In transit, keep the fixtures in cases. You wouldn't throw a prized guitar, drumset, or other piece of expensive gear into a gear trailer without a case, and similarly, you shouldn't even think about doing it with your shiny new light fixtures.

Common sense and taking care of your fixtures will be the single biggest thing you can do to keep them running at peak performance and let you worry about designing a great light show, putting on a great concert, or maximizing your client's satisfaction and "wow factor." That's what it's all about, after all!

Returns (Gasp!)

We've taken a lot of precautions to make sure you never even have to worry about sending a defective unit back, or sending a unit in for service. But, like any complex piece of equipment designed and built by humans, once in a while, something doesn't go as planned. If you find yourself with a fixture that isn't behaving like a good little fixture should, you'll need to obtain a Return Authorization (RA).

Don't worry, this is easy. Just go to our website and open a support ticket at www.blizzardpro.com/support, and we'll issue you an RA. Then, you'll need to send the unit to us using a trackable, pre-paid freight method. We suggest using USPS Priority or UPS. Make sure you carefully pack the fixture for transit, and whenever possible, use the original box & packing for shipping.

When returning your fixture for service, be sure to include the following:

- 1.) Your contact information (Name, Address, Phone Number, Email address).
- 2.) The RA# issued to you
- 3.) A brief description of the problem/symptoms.

We will, at our discretion, repair or replace the fixture. Please remember that any shipping damage which occurs in transit to us is the customer's responsibility, so pack it well!

Shipping Issues

Damage incurred in shipping is the responsibility of the shipper, and must be reported to the carrier immediately upon receipt of the items. Claims must be made within seven (7) days of receipt.

Tech Specs!

Weight & Dimensions					
Width	11.7 inches (298 mm)				
Depth	8.7 inches (221.7 mm)				
Height	14.6 inches (370 mm)				
Weight	7.1 lbs. (3.2 kg)				
Power					
Operating Voltage	110V-240VAC, 50-60Hz				
Power Consumption	105W, 1.49A, PF: .61				
Light Source					
LED	1x 200W RGB 3-in-1 COB LED				
Optical					
Beam Angle	45 degree beam angle				
Luminous Intensity	Lux/m	Red	Green	Blue	All
	1m	3,778	3,529	3,956	11,790
	2m	1,030	948	1,109	2,904
	3m	505	461	541	1,352
	4m	301	271	311	786
	5m	215	198	227	529
Thermal					
Max. Operating Temp.	104 degrees F (40 degrees C) ambient				
Control					
Protocol	USITT DMX-512				
DMX Channels	3/6-channel DMX modes				
Input	5-pin XLR Male				
Output	5-pin XLR Female				
Other Operating Modes	Standalone, Master/Slave, Auto, Sound Active				
Other Information					
Roman numerals. What are they good IV?					
Warranty	2-year limited warranty, does not cover malfunction caused by damage to LEDs.				

DISCLAIMER:

The power connector fitted to the fixture and fixture cord are designed for compatibility with products manufactured by Neutrik AG, Neutrik USA and their related entities, however they are not manufactured by, affiliated with or endorsed by Neutrik AG, Neutrik USA, or any related entity. Neutrik® and powerCON® are registered trademarks of Neutrik AG.

Dimensional Drawings

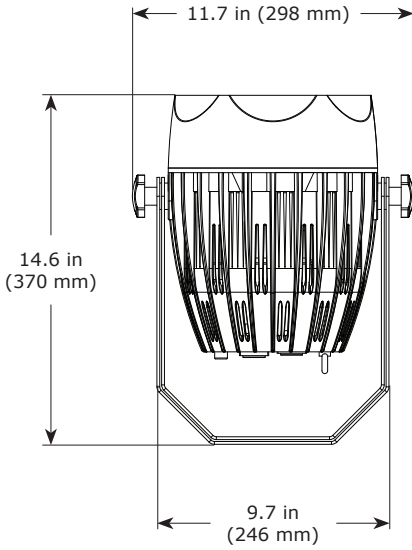
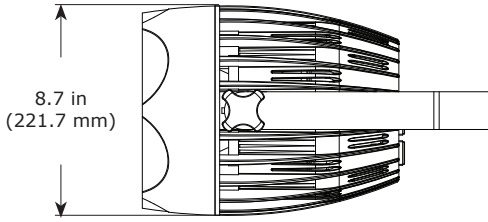

This page is intentionally left blank.

This page is intentionally left blank.



**Enjoy your product!
Our sincerest thanks for your purchase!
--The team @ Blizzard Lighting**