

---

# Quick Start Guide

## FreeStyle Mini LED & T41/T21 LED

(True Match® Firmware 5.0)

(RDM)



**KINO FLO**  
Lighting Systems

# FreeStyle Mini LED Kit



## **Kit-F10BU**

FreeStyle Mini LED Kit, Univ

### **FreeStyle Mini LED Kit consists of:**

- 1 FreeStyle Mini Fixture
- 1 Mounting Plate
- 1 Extension Cable
- 1 LED Controller
- 1 Soft Case

## FreeStyle Mini Kit Components



**CFX-F10** FreeStyle Mini LED Fixture



**MTP-BG41S** KinoGrip 41K Mount w/  
Baby Receiver Short (16mm)



**X08-F125** FreeStyle/1 Extension, 25ft



**LED-120X-120U**  
FreeStyle 120 LED DMX Controller, Univ 120U

**LED-120X-230U**  
FreeStyle 120 LED DMX Controller, Univ 230U



**BAG-FS10**  
FreeStyle Mini System Soft Case

# FreeStyle T41/T21 LED Systems



## **SYS-FT41U**

FreeStyle T41 LED DMX System, Univ

## **SYS-FT21U**

FreeStyle T21 LED DMX System, Univ

### **FreeStyle T41 or T21 LED System consists of:**

- 1 FreeStyle T41 or T21 Fixture
- 1 FreeStyle 4ft (or 2ft) LED Tube
- 1 Mounting Plate
- 1 Extension Cable
- 1 LED Controller

## FreeStyle T41/T21 System Components



**CFX-F481** FreeStyle T41 Fixture

**CFX-F241** FreeStyle T21 Fixture



**FS-48** FreeStyle 4ft LED Tube

**FS-24** FreeStyle 2ft LED Tube



**MTP-KG41** KinoGrip 41K Mount w/ 3/8" Pin (10mm)



**X08-F125** FreeStyle/1 Extension, 25ft



### **LED-120X-120U**

FreeStyle 120 LED DMX Controller, Univ 120U

### **LED-120X-230U**

FreeStyle 120 LED DMX Controller, Univ 230U

# Power

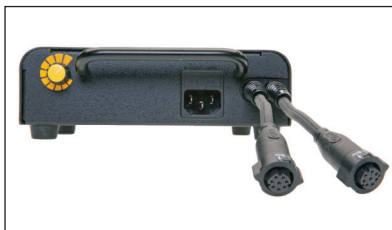

## AC Input

The FreeStyle 120 LED DMX Controller is powered AC and includes an IEC connection. It also includes a 12ft power cord with a locking IEC connector.

The FreeStyle 120 LED DMX has a built-in power supply with universal input from 100-240VAC.

## Ambient Operating Temperature

The FreeStyle 120 LED DMX is designed to operate at temperatures from 14°F to 104°F (-10°C to 40°C).



## DC Input

The FreeStyle 120 LED DMX can also be operated on 24VDC (input range 18-36VDC) through a 3-Pin XLR.

The pin polarity is:

- Pin # 1 – Ground
- Pin # 2 + 18-36VDC
- Pin # 3 not used



## Note:

A low voltage warning will display if input DC voltage is under 18VDC. Photo example: **LOW VDC: 16**

## FreeStyle Mini Fixture Assembly

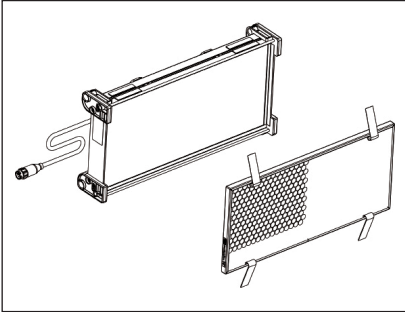

The FreeStyle Mini is comprised of an LED Panel and Louver. The Louver is held in place with Velcro Fasteners.

## FreeStyle T41/T21 Fixture Assembly

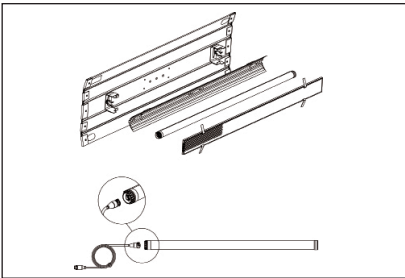

The FreeStyle T41/T21 fixtures are comprised of a Louver and Reflector.

The Louver and Reflector are held in place with Velcro fasteners.



The FreeStyle Reflector has a unique design to accommodate the aluminum channel on the back of the FreeStyle tube. It provides even light distribution and maximizes light output. In addition, it acts as a heatsink and allows the FreeStyle Tubes to run cooler.



Insert tube into the fixture's tube holder clips. The tube can operate remotely from the fixture allowing them to be built into sets or custom soft boxes or handheld as a single tube for an eye-light.

# Extension Cable



The FreeStyle T41, T21 and Mini LED fixtures can operate remotely from the controller with extension cable up to 50ft (2 x 25ft).

**X08-F125** FreeStyle/1 Extension, 25ft



## FreeStyle T41/T21

The extension cable connects directly to the LED tube. Align arrows on extension cable connector with tube. Push and click into place. To remove, turn locking ring to the left and pull.



## FreeStyle Mini/LED 120X Controller

To connect the extension cable to the FreeStyle Mini or LED 120X controller, align arrows on extension cable with connector. Push and click into place. To remove, turn locking ring to the left and pull.

# Mounting the Fixture

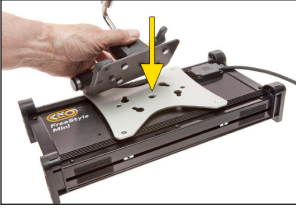

The FreeStyle fixtures have a universal mount. The ball and socket mount allows the fixture to be oriented in a broad range of angles.

Align the center pin of the mounting plate to the center hole on the mating plate.

Rotate plate clockwise until the four shoulder rivets drop into the receptacle. A locking pin will snap into place when the plate is properly seated.

The **yellow wire loops** (FreeStyle T41/21) provide attachment points for a safety chain.



**To remove the plate**, pull up on the locking pin and reverse the mounting procedure.

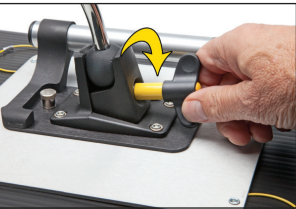

Turn the knob to loosen or tighten the mount.



Lollipops are interchangeable.

**MTP-L** Kino 41 Lollipop w/ 3/8" Pin (10mm)

**MTP-LBC** Kino 41 Lollipop w/ Baby Receiver Curve (16mm)

**MTP-LBS** Kino 41 Lollipop w/ Baby Receiver Short (16mm)

# Control Panel - White Mode

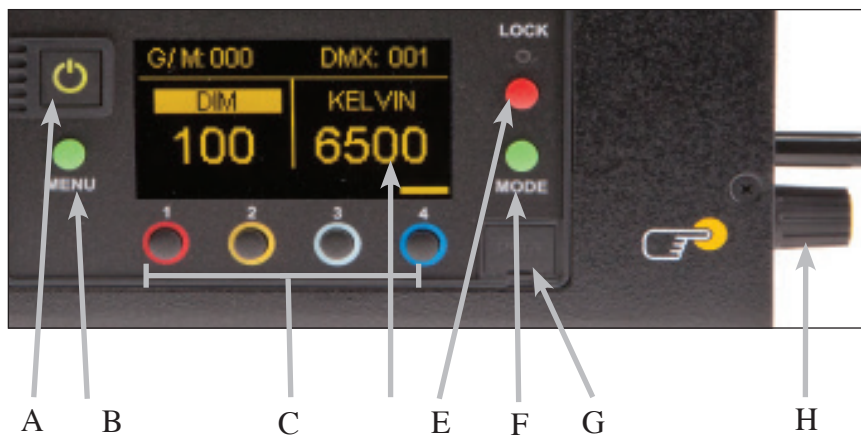

**A) On /Off:** **On** = Green light displayed. **Off** = Red light displayed. The display and all menu settings can be operated while the power button is in the Off position, as long as power is applied to the controller. The On /Off button only controls the light source.

**B) Menu:** Provides access to menu options such as General settings, Reset, DMX, DMX Wireless, Camera LUT and Color Space.  
Shortcut: While on control screen, press and hold for 3 seconds to switch through menus (**White, Gels & Hue, RGB, CIE xy and FX**).

**C) Preset Buttons:** Factory defaults left to right are: 2700K, 3200K, 5000K and 6500K. G/M default value is 000. User can also use these preset buttons to store custom Kelvin and G/M settings.

**D) Display:** Provides access to Dim, Kelvin, G/M, and DMX channel.  
Factory reset will show: Dim = 10%, Kelvin = 2700K, G/M = 000, DMX = 001.

**E) Lock:** Press the **Lock** button to disable all buttons and Control knob.  
Press for 3 seconds to restore displayed presets to default factory settings.

**F) Mode:** Press to navigate from Dim to Kelvin and G/M settings.  
When in sub-menus, pressing Mode always returns you to main display.  
When DMX is applied, use Mode to access DMX channel on main display.  
Shortcut: Long press will bring you back one step.

**G) Data Port:** Mini B USB for firmware updates.

**H) Control Knob:** Manually adjusts Dim, Kelvin, G/M levels and DMX address.  
Press the Control knob to toggle between **Fine** and **Coarse** increments or when selecting options within menus.

**DMX Note:** The LED-120X has an **"AUTO TERMINATE"** feature.  
The last fixture that does not have an XLR cable attached to the DMX "Out" port will automatically terminate.



# Control Panel - Gels/Hue Mode



## Gels/Hue Mode

### A) Menu:

Provides access to menu options such as General settings (**Gels/Hue Mode**), Reset, DMX, DMX Wireless, Camera LUT and Color Space.

Shortcut: While on control screen, press and hold for 3 seconds to switch through menus (**White, Gels & Hue, RGB, CIE xy and FX**).

### B) Preset Buttons:

Factory defaults left to right are: 2700K, 3200K, 5000K and 6500K.

G/M default value is 000. User can also use these preset buttons to store custom Kelvin between 2500K and 9900K and custom G/M, Gel, Hue and Saturation settings.

### C) Display:

Provides access to Dim, Kelvin, G/M, Gel, Hue/Saturation and DMX channel. Factory reset will show: Dim = 10%, Kelvin = 2700K, G/M = 000, DMX = 001.

### D) Mode:

Press to navigate from Dim to Kelvin, G/M, Gel, Hue and Saturation settings.

When on the Gel function, pushing the Control knob in/out will apply the gel or remove the gel. When in sub-menus, pressing Mode always returns you to main display. When DMX is applied, use Mode to access DMX channel on main display. Shortcut Tip: Long press will bring you back one step.

# Control Panel - RGB Mode

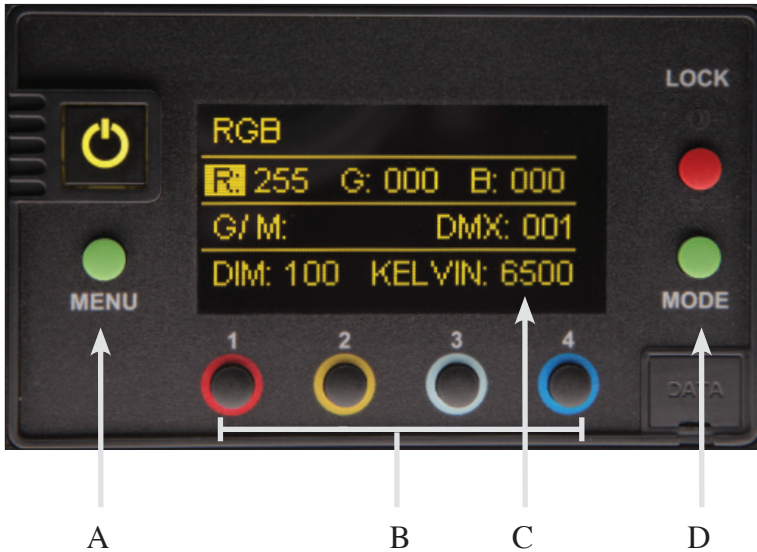

## RGB Mode

### A) Menu:

Provides access to menu options such as General settings (**RGB Mode**), Reset, DMX, DMX Wireless, Camera LUT and Color Space.

Shortcut: While on control screen, press and hold for 3 seconds to switch through menus (**White, Gels & Hue, RGB, CIE xy and FX**).

### B) Preset Buttons:

Factory defaults left to right are: 2700K, 3200K, 5000K and 6500K.

G/M default value is 000. User can also use these preset buttons to store custom Kelvin between 2500K and 9900K and custom G/M, and RGB settings.

### C) Display:

Provides access to Dim, Kelvin, G/M, RGB and DMX channel.

Factory reset will show: Dim = 10%, Kelvin = 2700K, G/M = 000, DMX = 001.

### D) Mode:

Press to navigate from Dim to Kelvin, G/M, RGB settings.

When in sub-menus, pressing Mode always returns you to main display.

When DMX is applied, use Mode to access DMX channel on main display.

Shortcut: Long press will bring you back one step.

# Control Panel - CIE xy

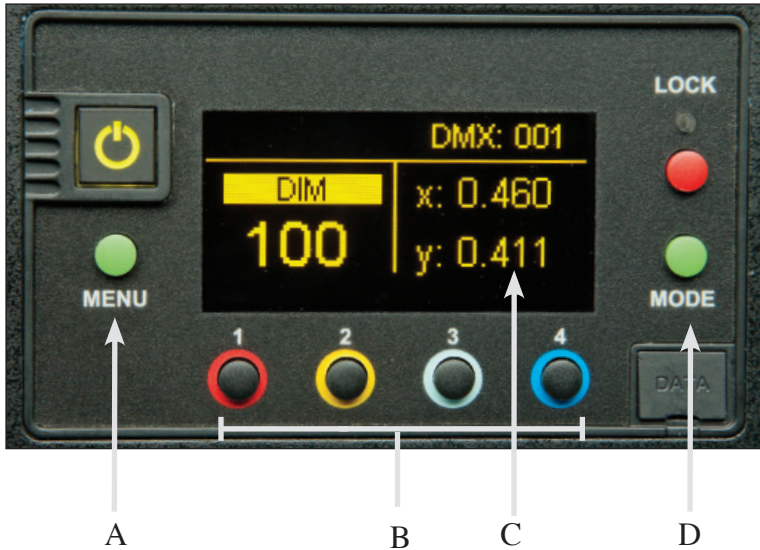

## CIE xy Mode

### A) Menu:

Provides access to menu options such as General settings (**CIE xy mode**), Reset, DMX, DMX Wireless, Camera LUT and Color Space.

Shortcut: While on control screen, press and hold or 3 seconds to switch through menus (**White, Gels & Hue, RGB, CIE xy and FX**).

### B) Preset Buttons:

Factory defaults left to right are: 2700K, 3200K, 5000K and 6500K. User can also use these preset buttons to store custom xy settings.

### C) Display:

Provides access to Dim, CIE xy coordinates and DMX Channel. Factory reset will show: Dim = 10%, x = 0.460 , y = 0.411, G/M = 000, DMX = 001.

### D) Mode:

Press to navigate from Dim to xy settings. When in sub-menus, pressing Mode always returns you to main display. When DMX is applied, use Mode to access DMX channel on main display. Shortcut: Long press will bring you back one step.

# Control Panel - FX (Effects)

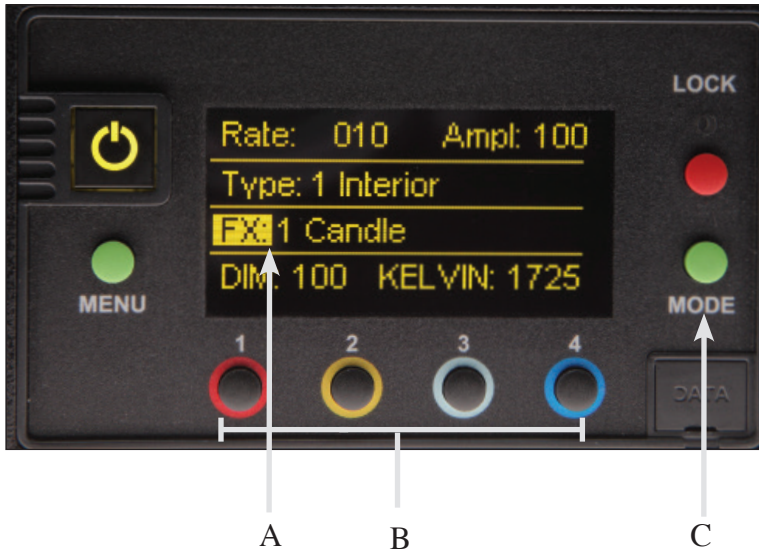

## FX (Effects) Mode

FX mode provides access to effects including Candle, Fire, TV, Police, Lightning, Paparazzi, Pulse and Scroll. Candle mode used as an example:

### A) FX Option:

Choose the desired FX Mode by rotating the control knob. When on the desired effect, there will be several pre-programmed effects as well as control parameters that can be altered.

### B) Preset Buttons:

In FX Mode, **Kelvin** custom settings and any control functions displayed such as **Rate** and **Amplitude (Ampl)** can be saved as a preset. Chosen values can be assigned to any preset button by holding down the desired button for 3 seconds. The Kelvin display will flash once the setting is registered.

To restore presets to default factory settings, choose **Reset** under **General** settings and **Clear Presets**. This method will reset all buttons in all Modes. Shortcut: If only want to clear presets for **Candle Mode**, hold **Lock** button for 3 seconds while Candle mode is displayed.

### C) Mode:

Press to navigate from Dim to Kelvin and FX settings.  
Shortcut: Long press will bring you back one step.

# Camera LUT



The **Camera LUT** (Look-up Tables) feature harmonizes the Kino Flo light sources to the camera. Depending on the camera and the Kelvin setting, some differences are very subtle, while others can be more dramatic.

The corrections are applied as a **CIE xy** correction at each CCT (Kelvin) setting. The default setting is targeting the CIE xyz response (human eye).

Press the green menu button to the left of the display screen and scroll down to **Camera LUT**, then press the control knob. Menu with camera selection will be displayed. Turn the control knob and press to select camera setting:

- C1 Arri Alexa**
- C2 Sony Venice**
- C3 Panavision DXL**
- C4 Panasonic Varicam**

The camera code (C1 for Arri Alexa), for example, will appear on the main menu between **DIM** and **CCT** to designate that a camera setting is active.

Note: When the controller is reset, the camera settings will go to Kino Flo Default mode.

# Color Space



**Color Space** defines the RGB color space used and only affects color – not Kelvin. It is used in **RGB** mode and **Hue Angle** and **Saturation**. There are a few instances in the FX (Effects) mode that are also affected when color is used. The RGB color space defines the value of Red, Green, and Blue primaries (in CIE xy) and the white point is fixed at 6500 Kelvin.

Press the green menu button to the left of the display screen and scroll down to **Color Space**, then press the control knob. Menu with color selection will be displayed. Turn the control knob and press to select Color Space options:

**rec 709 / sRGB**  
**P3 D65**  
**rec 2020**

The color space **rec 709 / sRGB** is commonly used on computer monitors, SDTV and HDTV television. There are slight gamma variations between rec 709 / sRGB, but not enough to separate into 2 color spaces.

The color space **P3 D65** is a common color space for digital movie projection. The color space **rec 2020** is used in ultra high definition television (UHDTV).

The color space is used when the controller is set to the RGB mode and when set to the Hue Angle/ Saturation mode.

In **RGB** mode – the color space designation will be displayed at the top of the menu. When changing the Red, Blue or Green values, the Kelvin will be locked in at 6500 for all color spaces. When the Kelvin is locked in, CCT will be displayed as CCT\*. When using Green/Magenta the CCT value is unlocked and color space selection has no impact.

In **Hue Angle/Saturation** mode – the color space designation will be displayed on the Gel line and GEL will be displayed as GEL\* and CCT will be displayed as CCT\*. The Color space will be displayed only when Hue Angle and Saturation are being used. When using Green/Magenta or Gel, the CCT will be unlocked and color space selection has no impact.

# Fixture Specifications



**FreeStyle Mini**

**CFX-F10** FreeStyle Mini LED Fixture

**Weight:** 3.5 lb (1.6kg)

**Dimensions:** 15 x 3 x 7.5"  
(38 x 8 x 19cm)



**FreeStyle T41**

**CFX-F481** FreeStyle T41 LED Fixture

**Weight w/ Tube:** 4 lb (1.8kg)

**Dimensions:** 52 x 5.5 x 3.5" w/ 4" barndoors  
(132 x 14 x 9cm w/ 10cm barndoors)



**FreeStyle T21**

**CFX-F241** FreeStyle T21 LED Fixture

**Weight w/ Tube:** 2.5 lb (1.1kg)

**Dimensions:** 28 x 5.5 x 3.5" w/ 4" barndoors  
(71 x 14 x 9cm w/ 10cm barndoors)

# LED Controller Specifications



**FreeStyle 120  
LED DMX Controller**

**LED-120X** FreeStyle 120 LED DMX Controller

**AC Input Voltage:** 100–240VAC 50/60Hz, 100W

**Amperage VAC:** 0.83A at 120VAC, 0.43A at 230VAC

**DC Input Voltage:** 18–36VDC, 100W

**Amperage VDC:** 4.2A at 24VDC

**Kelvin Range:** 2500K–9900K

**Dimming Range:** 100%–1%

**Weight:** 4 lb (1.8kg)

**Dimensions:** 9.5 x 7 x 2.5"  
(24 x 18 x 6.5cm)

**FCC Part 15 Verification:**

This device complies with Part 15 of the FCC Rules. Operation is subject to the condition that this device does not cause harmful interference.

**FCC Part 15 Declaration of Conformity:**

This device complies with Part 15 of the FCC Rules. Operation is subject to the following two conditions: (1) this device may not cause harmful interference, and (2) this device must accept any interference received, including interference that may cause undesired operation.



KINO FLO, INC  
**FreeStyle Mini, T41/T21 & LED-120X**  
ID: XRSCRMXTIMO101  
IC: 8879A-CRMXT101

The light source of this luminaire is not replaceable; when the light source reaches its end of life the whole luminaire shall be replaced. The luminaire is intended for professional use only.



For full operation manual, latest Warranty information and Certifications,  
see Kino Flo website at [www.kinoflo.com](http://www.kinoflo.com).

**Environmental: Disposal of Old Electrical & Electronic Equipment.**



This symbol on the product or on its packaging indicates that this product shall not be treated as household waste. This product is made of recyclable materials and should be disposed of in accordance with governmental regulations.

---

Kino Flo, Inc. 2840 N. Hollywood Way, Burbank, CA 91505, USA  
Tel: 818 767-6528 website: [www.kinoflo.com](http://www.kinoflo.com)